

UNITED STATES
SECURITIES AND EXCHANGE COMMISSION
Washington, D.C. 20549

POST-EFFECTIVE AMENDMENT NO. 2
TO
FORM F-1
REGISTRATION STATEMENT
Under
The Securities Act of 1933

YS Biopharma Co., Ltd.

(Exact name of Registrant as specified in its charter)

Not Applicable

(Translation of Registrant's name into English)

Cayman Islands	2834	Not Applicable
(State or Other Jurisdiction of Incorporation or Organization)	(Primary Standard Industrial Classification Code Number)	(I.R.S. Employer Identification Number)

**Building No. 2, 38 Yongda Road
Daxing Biomedical Industry Park
Daxing District, Beijing, PRC, 102629
Tel: +86-10 8920-2086**

(Address, including zip code, and telephone number, including area code, of Registrant's principal executive offices)

**Cogeny Global Inc.
122 East 42nd Street, 18th Floor,
New York, NY 10168
Tel: (212) 947-7200**

(Name, address, including zip code, and telephone number, including area code, of agent for service)

Copies to:

**Will H. Cai, Esq.
Cooley LLP
c/o Suites 3501-3505, 35/F
Two Exchange Square
8 Connaught Place
Central, Hong Kong
+852 3758-1200**

Approximate date of commencement of proposed sale to the public:

As soon as practicable after this registration statement becomes effective.

If any of the securities being registered on this Form are to be offered on a delayed or continuous basis pursuant to Rule 415 under the Securities Act of 1933 (as amended, the "Securities Act"), check the following box.

If this Form is filed to register additional securities for an offering pursuant to Rule 462(b) under the Securities Act, check the following box and list the Securities Act registration statement number of the earlier effective registration statement for the same offering.

If this Form is a post-effective amendment filed pursuant to Rule 462(c) under the Securities Act, check the following box and list the Securities Act registration statement number of the earlier effective registration statement for the same offering.

If this Form is a post-effective amendment filed pursuant to Rule 462(d) under the Securities Act, check the following box and list the Securities Act registration number of the earlier effective registration statement for the same offering.

Indicate by check mark whether the registrant is an emerging growth company as defined in Rule 405 of the Securities Act of 1933.

Emerging growth company

If an emerging growth company that prepares its financial statements in accordance with U.S. GAAP, indicate by check mark if the registrant has elected not to use the extended transition period for complying with any new or revised financial accounting standards[†] provided pursuant to Section 7(a)(2)(B) of the Securities Act.

The Registrant hereby amends this registration statement on such date or dates as may be necessary to delay its effective date until the Registrant shall file a further amendment which specifically states that this registration statement shall thereafter become effective in accordance with Section 8(a) of the Securities Act, as amended, or until the registration statement shall become effective on such date as the U.S. Securities and Exchange Commission, acting pursuant to said Section 8(a), may determine.

[†] The term "new or revised financial accounting standard" refers to any update issued by the Financial Accounting Standards Board to its Accounting Standards Codification after April 5, 2012.

EXPLANATORY NOTE

On May 12, 2023, YS Biopharma Co., Ltd filed Amendment No.1 to a Registration Statement on Form F-1 (Registration No. 333-271221), which was subsequently declared effective by the U.S. Securities and Exchange Commission (the “SEC”) on June 5, 2023 (the “Registration Statement”).

On August 8, 2023, YS Biopharma Co., Ltd. filed Post-effective Amendment No. 1 to the Registration Statement to update the Registration Statement to (i) include information contained in the registrant’s annual report on Form 20-F for the fiscal year ended March 31, 2023, initially filed with the SEC on July 26, 2023, and (ii) to update certain other information contained in the Registration Statement.

This Post-effective Amendment No. 2 is being filed to further update the Registration Statement to (i) include unaudited condensed consolidated financial information for the six months ended September 30, 2023 and (ii) update certain other information contained in the Post-effective Amendment No. 1 and the Registration Statement.

No additional securities are being registered under this Post-effective Amendment No. 2. All applicable registration fees were paid at the time of the original filing of the Registration Statement.

The information in this preliminary prospectus is not complete and may be changed. These securities may not be sold until the registration statement filed with the U.S. Securities and Exchange Commission, or “SEC,” is effective. This preliminary prospectus is not an offer to sell nor does it seek an offer to buy these securities in any jurisdiction where the offer or sale is not permitted.

SUBJECT TO COMPLETION, DATED JANUARY 23, 2024

PRELIMINARY PROSPECTUS

YS Biopharma Co., Ltd.

UP TO 24,130,762 ORDINARY SHARES

This prospectus relates to the offer and sale from time to time by the selling securityholders named herein or their pledgees, donees, transferees, or other successors in interest that receive any of the securities as a gift, distribution, or other non-sale related transfer (collectively, the “Selling Securityholders”) of up to 24,130,762 ordinary shares, par value \$0.00002 per share (“Ordinary Shares”), of YS Biopharma Co., Ltd. (“YS Biopharma,” “we” or “us”).

We are registering the offer and sale of these securities, in part, to satisfy certain registration rights we have granted. The Selling Securityholders may offer all or part of the securities for resale from time to time through public or private transactions, at either prevailing market prices or at privately negotiated prices. These securities are being registered to permit the Selling Securityholders to sell securities from time to time, in amounts, at prices and on terms determined at the time of offering. The Selling Securityholders may sell these securities through ordinary brokerage transactions, in underwritten offerings, directly to market makers of our securities or through any other means described in “Plan of Distribution” herein. In connection with any sales of securities offered hereunder, the Selling Securityholders, any underwriters, agents, brokers or dealers participating in such sales may be deemed to be “underwriters” within the meaning of the Securities Act of 1933, as amended.

Despite a potential decline in the public trading price of the Ordinary Shares, certain Selling Securityholders may still experience a positive rate of return on the securities that they sell pursuant to this prospectus as they have acquired the securities registered hereunder at prices substantially below current market prices, and may therefore have an incentive to sell their securities. However, the public holders of YS Biopharma’s securities may not experience a similar rate of return on the securities they purchase due to differences in the applicable purchase price and trading price.

Specifically, (1) Hui Shao acquired 2,002,780 Ordinary Shares at an average price of approximately \$0.00002 per share (including 1,802,780 Ordinary Shares held by Mountainview Investment Holdings LLC, a limited liability company incorporated under the laws of the State of Delaware and wholly-controlled by Mr. Hui Shao, and 200,000 Ordinary Shares directly held by Mr. Hui Shao), (2) Chunyuan Wu acquired 97,500 Ordinary Shares at an average price of approximately \$0.00002 per share, (3) Sunangal Ajit Shetty & Christine Maria M. Clerinx acquired 27,500 Ordinary Shares at an average price of approximately \$3.6 per share, (4) Viren T MEHTA & Amita RODMAN (as Trustees of V Mehta RLT & A Rodman RLT) acquired 35,000 Ordinary Shares at an average price of approximately \$3.6 per share, (5) Stanley Yi Chang acquired 82,111 Ordinary Shares at an average price of approximately \$0.12 per share, (6) Viren T Mehta acquired 72,500 Ordinary Shares at an average price of approximately \$0.00002 per share, (7) Sunangal Ajit Shetty acquired 72,500 Ordinary Shares at an average price of approximately \$0.00002 per share, (8) Asia Ventures II L.P. acquired 2,718,499 Ordinary Shares at an average price of approximately \$3.71 per share, (9) F-Prime Capital Partners Healthcare Fund III LP acquired 1,165,071 Ordinary Shares at an average price of approximately \$3.71 per share, (10) HH SUM XXXVI Holdings Limited acquired 751,790 Ordinary Shares at an average price of approximately \$6.65 per share, (11) Entities affiliated with OrbiMed acquired 4,298,465 Ordinary Shares at an average price of approximately \$6.27 per share, (12) Haitong Xu Yu International Limited acquired 187,948 Ordinary Shares at an average price of approximately \$6.65 per share, (13) Epiphron Capital (Hong Kong) Limited acquired 187,948 Ordinary Shares at an average price of approximately \$8.91 per share, (14) 3W Global Investment Limited acquired 187,948 Ordinary Shares at an average price of approximately \$6.65 per share, (15) Oceanpine Investment Fund II LP acquired 4,105,596 Ordinary Shares at an average price of approximately \$9.74 per share, (16) AIHC Master Fund acquired 718,480 Ordinary Shares at an average price of approximately \$9.74 per share, (17) 3W Global Fund acquired 2,052,798 Ordinary Shares at an average price of approximately \$9.74 per share, (18) MSA China Growth Fund II L.P. acquired 1,129,039 Ordinary Shares at an average price of approximately \$9.74 per share, (19) Superstring Capital Master Fund LP acquired 307,920 Ordinary Shares at an average price of approximately \$9.74 per share, (20) Wudaokou Capital Limited acquired 307,920 Ordinary Shares at an average price of approximately \$9.74 per share, (21) Gennex China Growth Fund acquired 205,280 Ordinary Shares at an average price of approximately \$9.74 per share, (22) Adjuvant Global Health Technology Fund, L.P. acquired 2,436,298 Ordinary Shares at an average price of approximately \$5.06 per share, and (23) Adjuvant Global Health Technology Fund DE, L.P. acquired 466,671 Ordinary Shares at an average price of approximately \$5.06 per share.

Given the substantial number of securities being registered for potential resale by the Selling Securityholders pursuant to this prospectus, the sale of such securities by the Selling Securityholders, or the perception in the market that the Selling Securityholders may or intend to sell all or a significant portion of such securities, could increase the volatility of the market price of our Ordinary Shares or result in a significant decline in the public trading price of our Ordinary Shares.

[Table of Contents](#)

We will not receive any proceeds from the sale of the securities by the Selling Securityholders.

Our Ordinary Shares and warrants to purchase our Ordinary Shares (“Warrants”) are listed on the Nasdaq Stock Market LLC (“NASDAQ”), under the trading symbols “YS” and “YSBPW,” respectively. On January 22, 2024, the closing price for our Ordinary Shares on Nasdaq was \$0.489599, and the closing price for our Warrants on Nasdaq was \$0.0353.

We may amend or supplement this prospectus from time to time by filing amendments or supplements as required. You should read this entire prospectus and any amendments or supplements carefully before you make your investment decision.

Throughout this prospectus, unless the context indicates otherwise, references to “YS Biopharma” refer to YS Biopharma Co., Ltd., formerly known as YishengBio Co., Ltd, a Cayman Islands holding company, references to “HK Yisheng” refer to YishengBio (Hong Kong) Holdings Limited, a wholly owned subsidiary of YS Biopharma, references to “US Yisheng” refer to Yisheng US Biopharma Inc., a wholly owned subsidiary of YS Biopharma, references to “Singapore Yisheng” refer to Yisheng Biopharma (Singapore) Pte. Ltd., a wholly owned subsidiary of YS Biopharma, references to “Liaoning Yisheng” refer to Liaoning Yisheng Biopharma Co., Ltd., a wholly owned subsidiary of YS Biopharma, references to “Beijing Yisheng” refer to Beijing Yisheng Biotechnology Co., Ltd., a wholly owned subsidiary of YS Biopharma, and references to “YS Group” refer to YS Biopharma, together as a group with its subsidiaries.

YS Biopharma is a Cayman Islands holding company that conducts operations in multiple countries, including China, Singapore and the Philippines through its subsidiaries, including Beijing Yisheng, Liaoning Yisheng, Singapore Yisheng, US Yisheng and Philippines Yisheng. Holders of YS Biopharma’s Ordinary Shares are not holding equity securities of its subsidiaries that have substantive business operations in China, Singapore and the Philippines, but instead are holding equity securities of a Cayman Islands holding company.

YS Group has substantial business and operations in China and thus are exposed to legal and operational risks associated with its operations in China. The PRC government has significant authority to exert influence on the ability of a company with operations in China, including YS Group, to conduct business. Changes in China’s economic, political or social conditions or government policies could materially and adversely affect its business and results of operations. Recent policy statements and regulatory actions by the PRC government, such as those related to human genetic data and biopharmaceutical and vaccine business, may adversely affect YS Group’s ability to conduct its business and research and development (“R&D”) activities, accept foreign investments, or list on a U.S. or other foreign stock exchange, which may cause the securities of YS Biopharma to be prohibited from trading or to be delisted from the Nasdaq or any other U.S. stock exchange. Furthermore, the PRC government recently instituted more regulations to exert more oversight and control over overseas securities offerings and other capital markets activities and foreign investment in China-based companies. Any such action, once taken by the PRC government, could significantly limit or completely hinder YS Biopharma’s ability to offer or continue to offer securities to investors and cause the value of such securities to significantly decline or in extreme cases, become worthless. For details, see “Risk Factors — Risks Related to Doing Business in China.”

YS Biopharma is subject to a number of prohibitions, restrictions and potential delisting risk under the Holding Foreign Companies Accountable Act (the “HFCAA”). Pursuant to the HFCAA and related regulations, if YS Biopharma has filed an audit report issued by a registered public accounting firm that the Public Company Accounting Oversight Board (the “PCAOB”) has determined that it is unable to inspect and investigate completely, the SEC will identify YS Biopharma as a “Commission-identified Issuer,” and the trading of YS Biopharma’s securities on any U.S. national securities exchanges, as well as any over-the-counter trading in the United States, will be prohibited if it is identified as a Commission-identified Issuer for two consecutive years. On December 16, 2021, the PCAOB issued a report to notify the Securities and Exchange Commission (the “SEC”) of its determination that it is unable to inspect or investigate completely PCAOB-registered public accounting firms headquartered in mainland China and Hong Kong without the approval of the Chinese authorities. While YS Biopharma’s auditor, Wei, Wei & Co., LLP, is headquartered in the United States and not subject to such determinations, there is no guarantee that the audit work carried out by Wei, Wei & Co., LLP in collaboration of its China-based offices can be inspected or investigated completely by the PCAOB without such approval. On August 26, 2022, the PCAOB signed a Statement of Protocol with the China Securities Regulatory Commission (“CSRC”) and the Ministry of Finance of the People’s Republic of China, taking the first step toward opening access for the PCAOB to inspect and investigate registered public accounting firms headquartered in mainland China and Hong Kong. On December 15, 2022, the

[Table of Contents](#)

PCAOB announced that it was able to secure complete access to inspect and investigate PCAOB registered public accounting firms headquartered in mainland China and Hong Kong completely in 2022. The PCAOB Board vacated its previous 2021 determinations that the PCAOB was unable to inspect or investigate completely registered public accounting firms headquartered in mainland China and Hong Kong. However, whether the PCAOB will continue to be able to satisfactorily conduct inspections of PCAOB-registered public accounting firms headquartered in mainland China and Hong Kong is subject to uncertainties and depends on a number of factors out of our and our auditor's control. The PCAOB continues to demand complete access in mainland China and Hong Kong moving forward and is making plans to resume regular inspections in early 2023 and beyond, as well as to continue pursuing ongoing investigations and initiate new investigations as needed. The PCAOB has also indicated that it will act immediately to consider the need to issue new determinations with the HFCAA if needed. YS Biopharma could still face the risk of delisting and cease of trading of its securities from a stock exchange or an over-the-counter market in the United States under the HFCAA and the securities regulations promulgated thereunder if the PCAOB is unable to inspect and investigate completely registered public accounting firms located in China in 2023 or beyond, or if YS Biopharma otherwise fails to meet the PCAOB's requirements. See the section entitled "Risk Factors — Risks Related to Doing Business in China — YS Biopharma's securities may be delisted under the Holding Foreign Companies Accountable Act if the PCAOB is unable to inspect auditors with presence in China in 2023 or beyond, and the delisting of its securities, or the threat of their being delisted, may materially and adversely affect the value of your investment."

Cash is transferred among YS Biopharma, its offshore subsidiaries and its PRC subsidiaries, in the following manner: (1) funds are transferred to its PRC subsidiaries from YS Biopharma as needed through YS Biopharma's subsidiaries outside China as capital contributions or shareholder loans, as the case may be; and (2) dividends or other distributions may be paid by its PRC subsidiaries to the Company through its subsidiaries outside China. YS Biopharma's subsidiaries in the PRC generate and retain cash generated from operating activities and re-invest it in its business. None of its subsidiaries outside China made distributions to shareholders. In the future, YS Biopharma's ability to pay dividends, if any, to its shareholders and warrant holders and to service any debt it may incur will depend upon dividends paid by its subsidiaries. In the fiscal years ended March 31, 2021, 2022 and 2023 and the six months ended September 30, 2023, YS Group did not transfer any cash proceeds to any of its PRC subsidiaries except for the cash transfers within its Group in connection with the paid-in capital in its PRC subsidiaries. \$59,900,000 of the registered capital was paid up by HK Yisheng to Liaoning Yisheng during the fiscal year ended March 31, 2021 and \$45,099,071.49 of the registered capital was paid up by HK Yisheng to Liaoning Yisheng during the fiscal year ended March 31, 2022. No registered capital was paid up by HK Yisheng to Liaoning Yisheng during the fiscal year ended March 31, 2023. \$1,008,767.58 of the registered capital was paid up by HK Yisheng to Beijing Yisheng during the six months ended September 30, 2023. In the future, cash proceeds raised from overseas financing activities may be transferred by YS Biopharma through its subsidiaries outside China to its PRC subsidiaries via capital contribution and shareholder loans, as the case may be. YS Biopharma's PRC subsidiaries will pay dividends to their offshore shareholder to meet the capital needs of YS Biopharma's business operations out of the PRC. For details about the applicable PRC regulations and rules relating to such cash transfers through YS Group and the associated risks, see "Risk Factors — Risks Related to Doing Business in China."

YS Biopharma is an "emerging growth company" as that term is used in the Jumpstart YS Biopharma's Business Startups Act of 2012, as amended (the "JOBS Act"), and, as such, may elect to comply with certain reduced public company reporting requirements in future reports.

YS Biopharma is also a "foreign private issuer" as defined in the Exchange Act, and is exempt from certain rules under the Exchange Act that impose certain disclosure obligations and procedural requirements for proxy solicitations under Section 14 of the Exchange Act. In addition, YS Biopharma's officers, directors and principal shareholders are exempt from the reporting and "short-swing" profit recovery provisions under Section 16 of the Exchange Act. Moreover, YS Biopharma is not required to file periodic reports and financial statements with the U.S. Securities and Exchange Commission as frequently or as promptly as U.S. companies whose securities are registered under the Exchange Act.

YS Biopharma is a "controlled company" as defined under the Nasdaq corporate governance rules, because Mr. Yi Zhang, Founder and Director of YS Biopharma, beneficially controls over 50% of the total voting power of all issued and outstanding Ordinary Shares through the acting-in-concert arrangement under a certain concert party agreement. See "Major Shareholders and Related Party Transactions — Concert Party Agreement" for details. As a result, Mr. Yi Zhang has the ability to exercise significant influence over matters requiring approval by shareholders such

[Table of Contents](#)

as decisions regarding election of directors and other significant corporate actions. YS Biopharma does not currently plan to utilize the exemptions available for controlled companies, but instead, it intends to rely on the exemption available for foreign private issuers to follow its home country governance practices. As a result, you will not have the same protection afforded to shareholders of companies that are subject to these corporate governance requirements. For details, see “Risk Factors — Risks Related to Ownership of the Ordinary Shares — As an exempted company incorporated in the Cayman Islands, YS Biopharma is permitted to adopt certain home country practices in relation to corporate governance matters that differ significantly from Nasdaq’s corporate governance requirements; these practices may afford less protection to shareholders. If YS Biopharma opts to rely on such exemptions in the future, such decision might afford less protection to holders of YS Biopharma’s ordinary shares” and “Risk Factors — Risks Related to Ownership of the Ordinary Shares — YS Biopharma is a “controlled company” within the meaning of the Nasdaq Stock Market listing rules and, as a result, may rely on exemptions from certain corporate governance requirements that provide protection to shareholders of other companies.”

Investing in YS Biopharma’s securities involves a high degree of risk. See “Risk Factors” beginning on page 17 of this prospectus and other risk factors contained in the documents incorporated by reference herein for a discussion of information that should be considered in connection with an investment in YS Biopharma’s securities.

Neither the U.S. Securities and Exchange Commission nor any other regulatory body has approved or disapproved of these securities or determined if this prospectus is truthful or complete. Any representation to the contrary is a criminal offense.

PROSPECTUS DATED JANUARY 23, 2024

TABLE OF CONTENTS

	PAGES
ABOUT THIS PROSPECTUS	1
FINANCIAL STATEMENT PRESENTATION	2
INDUSTRY AND MARKET DATA	3
FREQUENTLY USED TERMS	4
FORWARD-LOOKING STATEMENTS	6
SUMMARY OF THE PROSPECTUS	8
THE OFFERING	16
RISK FACTORS	17
CAPITALIZATION	85
SELECTED HISTORICAL FINANCIAL DATA OF YS BIOPHARMA	86
USE OF PROCEEDS	90
DIVIDEND POLICY	91
MARKET OPPORTUNITIES	92
BUSINESS	107
MANAGEMENT'S DISCUSSION AND FINANCIAL CONDITION AND RESULTS OF OPERATIONS	192
MANAGEMENT	220
BENEFICIAL OWNERSHIP OF SECURITIES	229
SELLING SECURITYHOLDERS	231
MAJOR SHAREHOLDERS AND RELATED PARTY TRANSACTIONS	234
DESCRIPTION OF YS BIOPHARMA'S SECURITIES	235
SHARES ELIGIBLE FOR FUTURE SALE	241
TAXATION	243
PLAN OF DISTRIBUTION	251
EXPENSES RELATED TO THE OFFERING	255
LEGAL MATTERS	255
EXPERTS	255
WHERE YOU CAN FIND MORE INFORMATION	258
INDEX TO FINANCIAL STATEMENTS	F-1

You should rely only on the information contained or incorporated by reference in this prospectus or any supplement. Neither we nor the Selling Securityholders have authorized anyone else to provide you with different information. The securities offered by this prospectus are being offered only in jurisdictions where the offer is permitted. You should not assume that the information in this prospectus or any supplement is accurate as of any date other than the date on the front of each document. Our business, financial condition, results of operations and prospects may have changed since that date.

Except as otherwise set forth in this prospectus, neither we nor the Selling Securityholders have taken any action to permit a public offering of these securities outside the United States or to permit the possession or distribution of this prospectus outside the United States. Persons outside the United States who come into possession of this prospectus must inform themselves about and observe any restrictions relating to the offering of these securities and the distribution of this prospectus outside the United States.

ABOUT THIS PROSPECTUS

This prospectus is part of a registration statement on Form F-1 filed with the SEC by YS Biopharma. The Selling Securityholders named in this prospectus may, from time to time, sell the securities described in this prospectus in one or more offerings. This prospectus includes important information about us, the securities being offered by the Selling Securityholders and other information you should know before investing. Any prospectus supplement may also add, update, or change information in this prospectus. If there is any inconsistency between the information contained in this prospectus and any prospectus supplement, you should rely on the information contained in that particular prospectus supplement. This prospectus does not contain all of the information provided in the registration statement that we filed with the SEC. You should read this prospectus together with the additional information about us described in the section below entitled “Where You Can Find More Information.” You should rely only on information contained in this prospectus. We have not, and the Selling Securityholders have not, authorized anyone to provide you with information different from that contained in this prospectus. The information contained in or incorporated by reference into this prospectus is accurate only as of the date on the front cover of the prospectus. You should not assume that the information contained in this prospectus is accurate as of any other date.

The Selling Securityholders may offer and sell the securities directly to purchasers, through agents selected by the Selling Securityholders, or to or through underwriters or dealers. A prospectus supplement, if required, may describe the terms of the plan of distribution and set forth the names of any agents, underwriters or dealers involved in the sale of securities. See “Plan of Distribution.”

Discrepancies in any table between totals and sums of the amounts listed are due to rounding. Certain amounts and percentages have been rounded; consequently, certain figures may add up to be more or less than the total amount and certain percentages may add up to be more or less than 100% due to rounding. In particular and without limitation, amounts expressed in millions contained in this prospectus have been rounded to a single decimal place for the convenience of readers.

FINANCIAL STATEMENT PRESENTATION

YS Biopharma

The consolidated statements of operations and other comprehensive loss data for the fiscal years ended March 31, 2021, 2022 and 2023 and consolidated statements of financial position data of YS Biopharma as of March 31, 2022 and 2023 as well as the unaudited financial statements as of September 30, 2023 and for the six months ended September 30, 2023 have been prepared and presented in accordance with generally accepted accounting principles in the United States ("U.S. GAAP") and are denominated in U.S. Dollars.

INDUSTRY AND MARKET DATA

The industry and market position information that appears in this prospectus is from independent market research carried out by Frost & Sullivan, which was commissioned by YS Biopharma. We refer to this research report as the F&S report.

Such information is supplemented where necessary with YS Biopharma's own internal estimates and information obtained from discussions with its customers, taking into account publicly available information about other industry participants and YS Biopharma's management's judgment where information is not publicly available. This information appears in "Summary of the Prospectus," "Business" and "Management's Discussion and Analysis of Financial Condition and Results of Operations" and other sections of this prospectus.

FREQUENTLY USED TERMS

Unless otherwise stated or unless the context otherwise requires in this document:

“Amended YS Biopharma Articles” means YS Biopharma’s amended and restated memorandum and articles adopted by special resolution passed on September 23, 2022, which became effective on March 16, 2023;

“Beijing Yisheng” means Beijing Yisheng Biotechnology Co., Ltd., a company incorporated under the laws of the PRC with limited liability and a wholly-owned subsidiary of YS Biopharma;

“Board” means YS Biopharma’s board of directors;

“Business Combination” or “Transactions” means the Mergers and the other transactions contemplated by the Business Combination Agreement which was consummated on March 16, 2023;

“Business Combination Agreement” means the business combination agreement, dated September 29, 2022 (as may be amended, supplemented, or otherwise modified from time to time), by and among Summit, Merger Sub I, Hudson Biomedical Group and YS Biopharma;

“Cayman Islands Companies Act” means the Companies Act (As Revised) of the Cayman Islands;

“CDC(s)” means Chinese Center(s) for Disease Control and Prevention;

“China” or “PRC” means the People’s Republic of China (and, only in the context of describing the industry matters, and the PRC laws, rules, regulations, regulatory authorities, and any PRC entities or citizens under such rules, laws and regulations and other legal, regulatory or tax matters and advices in this prospectus, excludes Hong Kong, Macau and Taiwan). The term “Chinese” has a correlative meaning for the purpose of this prospectus;

“Code” means the Internal Revenue Code of the 1986, as amended;

“Exchange Act” means the U.S. Securities Exchange Act of 1934, as amended;

“HK Yisheng” means YishengBio (Hong Kong) Holdings Limited, a company incorporated under the laws of Hong Kong with limited liability and a wholly-owned subsidiary of YS Biopharma;

“Hudson Biomedical Group” means Hudson Biomedical Group Co., Ltd., an exempted company limited by shares incorporated under the laws of the Cayman Islands and a direct wholly-owned subsidiary of YS Biopharma;

“KOL(s)” means key opinion leader(s);

“Liaoning Yisheng” means Liaoning Yisheng Biopharma Co., Ltd., a company with limited liability under the laws of the PRC with limited liability and a wholly-owned subsidiary of YS Biopharma;

“Mergers” means collectively, the First Merger and the Second Merger;

“Merger Subs” means collectively Merger Sub I and Hudson Biomedical Group;

“Merger Sub I” means Oceanview Bioscience Acquisition Co., Ltd., an exempted company limited by shares incorporated under the laws of the Cayman Islands which was struck off as part of the First Merger;

“Nasdaq” means the Nasdaq Stock Market;

“PCAOB” means the Public Company Accounting Oversight Board;

“PFIC” means a “passive foreign investment company” for U.S. federal income tax purposes;

“Philippines Yisheng” means YS BIOPHARMA (PHILIPPINES) INC., a company incorporated under the laws of the Philippines with limited liability and YS Biopharma’s wholly-owned subsidiary;

“PRC” means the People’s Republic of China;

Table of Contents

“Resale by the Selling Securityholders” means the transactions constituting the offer and sale, from time to time, by any of the Selling Securityholders or their pledgees, donees, transferees, or other successors in interest that receive any of the securities as a gift, distribution, or other non-sale related transfer of up to 24,130,762 Ordinary Shares, par value \$0.00002 per share, as described in this prospectus;

“Sarbanes-Oxley Act” means the Sarbanes-Oxley Act of 2002, as amended;

“SEC” means the U.S. Securities and Exchange Commission;

“Securities Act” means the U.S. Securities Act of 1933, as amended;

“Singapore Yisheng” means Yisheng Biopharma (Singapore) Pte. Ltd., (formerly known as Newbiomed Pika Pte. Ltd.), a company incorporated under the laws of Singapore and a wholly-owned subsidiary of YS Biopharma;

“Sponsor” means Summit Healthcare Acquisition Sponsor LLC, a limited liability company registered under the laws of the Cayman Islands;

“Summit” means Summit Healthcare Acquisition Corp., an exempted company limited by shares incorporated under the laws of the Cayman Islands;

“U.S. dollars”, “US\$” or “\$” means United States dollars, the legal currency of the United States;

“U.S. GAAP” means generally accepted accounting principles in the United States as in effect from time to time;

“US Yisheng” means Yisheng US Biopharma Inc., a company incorporated under the laws of U.S. and a wholly-owned subsidiary of YS Biopharma;

“YS Biopharma” means YS Biopharma Co. Ltd., formerly known as YishengBio Co., Ltd, an exempted company with limited liability incorporated under the laws of the Cayman Islands;

“YS Biopharma Capital Restructuring” means (1) the conversion of each preferred share of YS Biopharma into one Ordinary Share before YS Biopharma Share Consolidation and (2) YS Biopharma Share Consolidation;

“Ordinary Share” means ordinary shares of YS Biopharma, par value \$0.00002 per share, the rights, preferences, privileges and restrictions of which are as set out in the Amended YS Biopharma Articles;

“YS Biopharma Share Consolidation” means the consolidation of every four pre-consolidation Ordinary Shares and options of YS Biopharma into one Ordinary Share and one option of YS Biopharma, respectively, subject to rounding up to the nearest whole number of shares;

“Warrant” means warrant to purchase Ordinary Share, with each whole warrant entitling the holder to purchase one Ordinary Share; and

“YS Group” means YS Biopharma, together as a group with its subsidiaries, including Merger Sub I, Hudson Biomedical Group, US Yisheng, Singapore Yisheng and HK Yisheng, Liaoning Yisheng and Beijing Yisheng.

FORWARD-LOOKING STATEMENTS

This prospectus includes statements that express YS Biopharma's opinions, expectations, beliefs, plans, objectives, assumptions or projections regarding future events or future results of operations or financial condition and therefore are, or may be deemed to be, "forward-looking statements." These forward-looking statements can generally be identified by the use of forward-looking terminology, including the terms "believes," "estimates," "anticipates," "expects," "seeks," "projects," "intends," "plans," "may," "will" or "should" or, in each case, their negative or other variations or comparable terminology. These forward-looking statements include all matters that are not historical facts. They appear in a number of places throughout this prospectus and include statements regarding YS Biopharma's intentions, beliefs or current expectations concerning, among other things, results of operations, financial condition, liquidity, prospects, growth, strategies, future market conditions or economic performance and developments in the capital and credit markets and expected future financial performance, the markets in which YS Group operates as well as any information concerning possible or assumed future results of operations of YS Group. Such forward-looking statements are based on available current market material and management's expectations, beliefs and forecasts concerning future events impacting YS Group and YS Biopharma. Factors that may impact such forward-looking statements include:

- the regulatory environment and changes in laws, regulations or policies in the jurisdictions in which YS Group operates;
- YS Group's ability to successfully compete in highly competitive industries and markets;
- YS Group's ability to continue to adjust its offerings to meet market demand, attract customers to choose its products and services and grow its ecosystem;
- political instability in the jurisdictions in which YS Group operates;
- the overall economic environment and general market and economic conditions in the jurisdictions in which YS Group operates;
- YS Group's ability to execute its strategies, manage growth and maintain its corporate culture as it grows;
- YS Group's anticipated investments in new products, services, collaboration arrangements, technologies and strategic acquisitions, and the effect of these investments on its results of operations;
- YS Group's ability to develop and protect intellectual property;
- changes in the need for capital and the availability of financing and capital to fund these needs;
- anticipated technology trends and developments and YS Group's ability to address those trends and developments with its products and services;
- the safety, affordability, convenience and breadth of YS Group's products and services;
- man-made or natural disasters, health epidemics, and other outbreaks including war, acts of international or domestic terrorism, civil disturbances, occurrences of catastrophic events and acts of God such as floods, earthquakes, wildfires, typhoons and other adverse weather and natural conditions that affect YS Group's business or assets;
- the loss of key personnel and the inability to replace such personnel on a timely basis or on acceptable terms;
- exchange rate fluctuations;
- changes in interest rates or rates of inflation;
- legal, regulatory and other proceedings; and
- YS Biopharma's ability to maintain the listing of its securities on Nasdaq; and the results of future financing efforts.

[Table of Contents](#)

The forward-looking statements contained in this prospectus are based on YS Biopharma's current expectations and beliefs concerning future developments and their potential effects on YS Biopharma. There can be no assurance that future developments affecting YS Biopharma will be those that YS Biopharma has anticipated. These forward-looking statements involve a number of risks, uncertainties (some of which are beyond YS Biopharma's control) or other assumptions that may cause actual results or performance to be materially different from those expressed or implied by these forward-looking statements. These risks and uncertainties include, but are not limited to, those factors described under the heading "Risk Factors." Should one or more of these risks or uncertainties materialize, or should any of the assumptions prove incorrect, actual results may vary in material respects from those projected in these forward-looking statements. YS Biopharma will not undertake any obligation to update or revise any forward-looking statements, whether as a result of new information, future events or otherwise, except as may be required under applicable securities laws.

Before an investor makes an investment decision in YS Biopharma's securities, it should be aware that the occurrence of the events described in "Risk Factors" and elsewhere in this prospectus may adversely affect YS Biopharma.

SUMMARY OF THE PROSPECTUS

This summary highlights selected information from this prospectus and does not contain all of the information that is important to you in making an investment decision. This summary is qualified in its entirety by more detailed information included in this prospectus. Before making your investment decision with respect to YS Biopharma's securities, you should read this entire document carefully, including the information under "Risk Factors," "Management's Discussion and Analysis of Financial Condition and Results of Operations" and the financial statements included elsewhere in this prospectus. Each item in this summary refers to the page of this prospectus on which that subject is discussed in more detail.

Overview

YS Group is a global biopharmaceutical company dedicated to discovering, developing, manufacturing and commercializing new generations of vaccines and therapeutic biologics for infectious diseases and cancer. YS Group commercializes vaccines with significant revenue and growth potential. YS Group takes pride in its marketed vaccine product, YSJA rabies vaccine, which was the first aluminum-free lyophilized rabies vaccine launched in China. Since YS Group launched its production at its current GMP-compliant facilities in February 2020 and as of September 30, 2023, YS Group had sold more than 23.5 million doses of YSJA rabies vaccines to 1,718 county-level CDCs in China. YS Group has also developed its proprietary PIKA immunomodulating technology platform, empowering a robust pipeline of innovative vaccines and therapeutic biologics. As of September 30, 2023, YS Group had four product candidates at various clinical trial stages, including PIKA rabies vaccine, PIKA recombinant COVID-19 vaccine, PIKA YS-ON-001 and PIKA YS-HBV-001, and four preclinical stage product candidates, targeting HBV, influenza, rabies and cancer with significant unmet medical needs. In addition, YS Group is working on a series of therapeutic targets and products at the discovery stage.

YS Biopharma was incorporated under the laws of Cayman Islands as an exempted company with limited liability in November 2020. The history of YS Group can be traced back to 2002 when Mr. Yi Zhang, its founder and controlling shareholder started the vaccine business in the PRC, and has expanded its international business operation in the United States and Singapore since 2009.

The following diagram illustrates the corporate structure of YS Group as of the date of this prospectus.

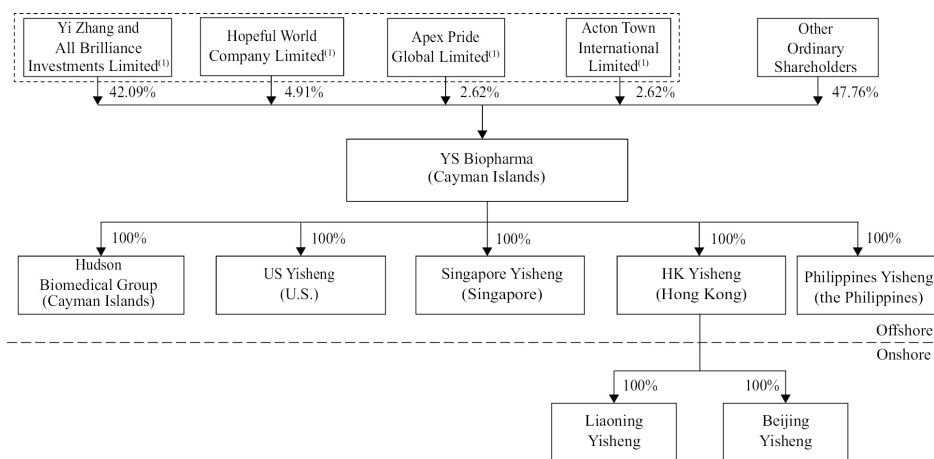

(1) (i) Mr. Yi Zhang and the entities he controls, including An Diang Group Holdings Limited, YXRT Company Limited and All Brilliance Investments Limited; (ii) Ms. Rui Mi and the entities controlled by Ms. Rui Mi, including Honeydrew Flower Field Ltd., ZM Home Limited and Hopeful World Company Limited; (iii) Ms. Xu Zhang and the entities controlled by Ms. Xu Zhang, including Apex Pride Global Limited, Prosperous Sunrise Company Limited and Much Galaxy Company Limited; and (iv) Ms. Nan Zhang and the entities controlled by Ms. Nan Zhang, including Spring Nanmu Islands Ltd., NNZF Company Limited and Acton Town International Limited (the "Concert Parties") entered into a concert party agreement

dated March 3, 2021 (the “Concert Party Agreement”), pursuant to which, the concert parties agree and acknowledge that they have voted since commencement of YS Group’s business, and will continue to vote, themselves or through any entity directly or indirectly controlled by them that own YS Biopharma’s equity interest, unanimously for any resolutions proposed at the board meetings and/or shareholders meeting of YS Biopharma, where applicable. According to the Concert Party Agreement, if the Concert Parties are unable to reach unanimous consensus, Yi Zhang is entitled to determine how to vote for and on behalf of himself and the Concert Parties. The Concert Agreement remains effective unless otherwise terminated by mutual consent of the Concert Parties.

On September 29, 2022, YS Biopharma entered into the Business Combination Agreement with Summit, Merger Sub I and Hudson Biomedical Group. The Business Combination Agreement provides for (1) the merger of Merger Sub I with and into Summit (the “First Merger”), with Summit surviving the First Merger as the surviving entity (the “Surviving Entity”) and becoming a wholly-owned subsidiary of YS Biopharma, and (2) the merger of the Surviving Entity with and into Hudson Biomedical Group (the “Second Merger,” and together with the First Merger, the “Mergers,” together with other transactions contemplated by the Business Combination Agreement, the “Business Combination”), with Hudson Biomedical Group surviving the Second Merger as the surviving company (the “Surviving Company”) and remaining as a wholly-owned subsidiary of YS Biopharma. As a result of and upon consummation of the Business Combination, the holders of shares and/or warrants of Summit has become the holders of shares and/or warrants of YS Biopharma.

Subject to, and in accordance with the terms and conditions set forth in the Business Combination Agreement, 19,388,769 shares of Summit were redeemed by Summit’s public holders. As a result, an aggregate of 1,708,497 Ordinary Shares, including 1,446,525 Ordinary Shares contributed by the Sponsor through a share surrender immediately prior to the First Merger Effective Time and 261,972 newly issued Ordinary Shares, were provided to non-redeeming Summit Shareholders and the Forward Purchase Investors (as defined below).

Prior to Summit’s initial public offering (the “Summit IPO”), Summit had entered into forward purchase agreements (collectively, the “Forward Purchase Agreements”) with each of Snow Lake Capital (HK) Limited and the Valliance Fund (collectively, the “Forward Purchase Investors”). The Forward Purchase Agreements provide for (1) the transfer of an aggregate of 375,000 Founder Shares from the Sponsor to the Forward Purchase Investors for nil cash consideration prior to the Summit IPO and (2) the purchase by the Forward Purchase Investors of an aggregate of 3,000,000 Summit Class A Ordinary Shares, plus an aggregate of 750,000 redeemable warrants to purchase Summit Class A Ordinary Shares at \$11.50 per share, for an aggregate purchase price of \$30,000,000 in a private placement to close concurrently with the closing of Summit’s initial business combination, which was the consummation of the Business Combination. Forward Purchase Investors had fully delivered their respective portion of the Forward Purchase Investment Amount as required under the applicable Forward Purchase Agreements.

The Business Combination was consummated on March 16, 2023. The transaction was unanimously approved by Summit’s board of directors and was approved at the extraordinary general meeting of Summit’s shareholders held on March 14, 2023. Summit’s shareholders also voted to approve all other proposals presented at the extraordinary general meeting. On March 17, 2023, the Ordinary Shares and Warrants commenced trading on The Nasdaq Stock Market LLC, or “Nasdaq” under the symbols “YS” and “YSBPW,” respectively.

The mailing address of YS Biopharma’s principal executive office is Building No. 2, 38 Yongda Road Daxing Biomedical Industry Park, Daxing District, Beijing, PRC, and its phone number is +86-10-89202086. YS Biopharma’s corporate website address is <https://www.ysbiopharm.com>. YS Biopharma’s website and the information contained on, or that can be accessed through, the website is not deemed to be incorporated by reference in, and is not considered part of, this prospectus.

Risk Factor Summary

Shareholders should carefully read this prospectus and especially consider the factors discussed in “Risk Factors,” a summary of which is set forth below. The occurrence of one or more of the events or circumstances described below, alone or in combination with other events or circumstances, may have an adverse effect on YS Group’s business, cash flows, financial condition and results of operations.

Risks Related to YS Group’s Business and Products

There are various risks related to YS Group’s business and operations, which include, but are not limited to:

- YS Group depends on its current marketed rabies vaccine product to generate substantially all of its revenue in the near term. YS Group’s previous operating history of manufacturing and commercializing vaccines may not provide an adequate basis to judge the viability of its business, the effectiveness of its management and its future profitability and prospects in respect of its marketed product.
- YS Group faces substantial competition. Its competitors may discover, develop or commercialize products before, or more successfully than, YS Group do, or develop therapies that are more advanced or effective than that developed by YS Group, which may adversely affect YS Group’s financial condition and its ability to successfully market or commercialize its marketed product and product candidates.
- YS Group’s product candidates, once commercialized, may compete with its existing marketed product.
- If the rabies vaccine industry in China does not grow as expected or declines, YS Group’s ability to expand its business and results of operations could be materially and adversely affected.
- The commercial success of any of YS Group’s marketed product and product candidates depends on its degree of market acceptance by end-users, CDCs, KOLs and others related to the vaccine or disease prevention industry.
- The biopharmaceutical industry is highly regulated. The relevant regulations and policies are complex and regional and subject to changes from time to time. YS Group’s ability to obtain and maintain these regulatory approvals is uncertain. Any change in government regulation and policy may place additional burdens on YS Group’s business and have a material adverse effect on YS Group’s financial condition and results of operations.
- YS Group’s marketed product and product candidates may become subject to unfavorable pricing regulations, third-party reimbursement practices or healthcare reform initiatives, which could harm YS Group’s business.
- YS Group currently relies on the manufacturing facilities for the marketed product and are still developing additional facilities at other sites. Any disruption of YS Group’s current and new facilities or their failure to meet GMP regulatory compliance or other regulatory requirements may have a material adverse effect on YS Group’s business, financial condition and results of operations.
- Failure to manage the normal manufacturing capacity properly may materially and adversely affect YS Group’s revenues and profitability.
- YS Group has incurred significant losses since its inception. YS Group might incur losses or fail to generate sufficient revenue to achieve satisfactory profitability in the future.
- YS Group’s financial prospects depend on the sale of its marketed product, and the successful development and approval of its clinical-stage and preclinical stage product candidates.
- YS Group may need to obtain substantial additional financing to fund its operations, and a failure to obtain necessary capital when needed would force YS Group to delay, limit, reduce or terminate its product development or commercialization efforts.
- The issuance, scope, validity, enforceability and commercial value of YS Group’s patent rights are highly uncertain, and there can be no assurance that any of YS Group’s technology, marketed product or product candidates will be protectable or remain protected by valid and enforceable patents. If YS Group is unable

to obtain and maintain patent protection for its marketed product and product candidates, or if the scope of such patent protection obtained is not sufficiently broad, third parties may compete directly against YS Group.

- YS Group could be adversely affected by the ongoing global impacts and uncertainties of the COVID-19 pandemic or similar pandemics in the future.

For additional detail on these and other risks, see “Risk Factors — Risks Related to YS Group’s Business and Products” beginning on page 17 of this prospectus.

Risks Related to Doing Business in China

YS Group faces various legal and operational risks associated with doing business in China, which could cause the value of YS Biopharma’s securities to decline or become worthless, and significantly limit or completely hinder its ability to accept foreign investments and offer or continue to offer securities to foreign investors. These risks include, but are not limited to:

- YS Group has a substantial business and operation in China and thus is exposed to legal and operational risks associated with its operations in China. The PRC government has significant authority to exert influence on the ability of a company with operations in China, including YS Group, to conduct its business. Changes in China’s economic, political or social conditions or government policies could materially and adversely affect its business and results of operations. For example, YS Group faces risks associated with regulatory approvals of offshore offerings, anti-monopoly regulatory actions, oversight on cybersecurity and data privacy, as well as the lack of PCAOB inspection on its auditors. On December 16, 2021, the PCAOB issued a report to the SEC of its determination that it is unable to inspect or investigate completely PCAOB-registered public accounting firms headquartered in mainland China and Hong Kong without the approval of the Chinese authorities. While YS Biopharma’s auditor, Wei, Wei & Co., LLP, is headquartered in the United States and not subject to such determinations, there is no guarantee that the audit work by Wei, Wei & Co., LLP in collaboration with its China-based offices can be inspected or investigated completely by the PCAOB without such approval. On August 26, 2022, the PCAOB signed a Statement of Protocol with the China Securities Regulatory Commission (the “CSRC”) and the Ministry of Finance of the PRC, taking the first step toward opening access for the PCAOB to inspect and investigate registered public accounting firms headquartered in mainland China and Hong Kong. On December 15, 2022, the PCAOB announced it was able to secure complete access to inspect and investigate PCAOB-registered public accounting firms headquartered in mainland China and Hong Kong completely in 2022. The PCAOB Board vacated its previous 2021 determinations that the PCAOB was unable to inspect or investigate completely registered public accounting firms headquartered in mainland China and Hong Kong. However, whether the PCAOB will continue to be able to satisfactorily conduct inspections of PCAOB-registered public accounting firms headquartered in mainland China and Hong Kong is subject to uncertainties and depends on a number of factors out of YS Biopharma’s and its auditor’s control. The PCAOB continues to demand complete access in mainland China and Hong Kong moving forward and is making plans to resume regular inspections in early 2023 and beyond, as well as to continue pursuing ongoing investigations and initiate new investigations as needed. The PCAOB has also indicated it will act immediately to consider the need to issue new determinations with the HFCAA if needed. YS Biopharma could still face the risk of delisting and cease of trading of its securities from a stock exchange or an over-the-counter market in the United States under the HFCAA and the securities regulations promulgated thereunder if the PCAOB is unable to inspect and investigate completely registered public accounting firms located in China in 2023 or beyond, or if YS Biopharma otherwise fails to meet the PCAOB’s requirements. These China-related risks could result in a material change in its operations and/or the value of YS Biopharma’s securities, or could significantly limit or completely hinder the ability of YS Biopharma to offer or continue to offer securities to investors and cause the value of such securities to significantly decline or become worthless. See “Risk Factors — Risks Related to Doing Business in China.”
- The PRC government has significant oversight and discretion over the conduct of YS Group’s business and operations and may intervene with or influence its operations as the government deems appropriate to further regulatory, political and societal goals. Recent policy statements and regulatory actions by the PRC government, such as those related to human genetic data and biopharmaceutical and vaccine

business, may adversely impact YS Group's ability to conduct its business and R&D activities, accept foreign investments, or list on a U.S. or other foreign stock exchange, which may cause the securities of YS Biopharma to be prohibited from trading or to be delisted from the Nasdaq or any other U.S. stock exchange. Furthermore, the PRC government recently instituted new regulations to exert more oversight and control over overseas securities offerings and other capital markets activities and foreign investment in China-based companies. Any such action, once taken by the PRC government, could significantly limit or completely hinder YS Group's ability to offer or continue to offer securities to investors and cause the value of such securities to significantly decline or in extreme cases, become worthless.

- The M&A Rules purport to require offshore special purpose vehicles that are controlled by PRC companies or individuals and that have been formed for the purpose of seeking a public listing on an overseas stock exchange through acquisitions of PRC domestic companies or assets to obtain CSRC approval prior to publicly listing their securities on an overseas stock exchange. The interpretation and application of the M&A Rules remain unclear.

There is no assurance, however, that regulators in China will not subsequently require YS Biopharma to undergo the approval or clearance procedures in relation to the Nasdaq listing through a de-SPAC transaction or the Resale by the Selling Securityholders and subject YS Biopharma to penalties for non-compliance. See "Risk Factors — Risks Related to Doing Business in China — Recent regulatory development in China may exert more oversight and control over listing and offerings that are conducted overseas. The approval, filing and/or other requirements of PRC governmental authorities may be required under PRC laws, regulations or policies."

- On February 17, 2023, the CSRC issued the Trial Administrative Measures of the Overseas Securities Offering and Listing by Domestic Companies (the "Trial Administrative Measures for Overseas Listing") and five supporting guidelines, which came into effect on March 31, 2023. According to the Trial Administrative Measures for Overseas Listing and the CSRC press release regarding the Trial Administrative Measures for Overseas Listing published on its official website on February 17, 2023, an indirect overseas offering and listing by domestic companies, which refers to the offering and listing by a company by way of an overseas incorporated entity the major business operations of which are located domestically and such offering and listing is based on the underlying equity, assets, earnings or other similar rights of a domestic company, is subject to filing procedures with the CSRC. A company having been listed overseas before the effectiveness of the Trial Administrative Measures for Overseas Listing would only be subject to the filing requirements when conducting a follow-on offering of securities. As YS Biopharma would not additionally issue any new Ordinary Shares or other equity securities from the Resale by the Selling Securityholders, YS Biopharma believes that, as advised by its PRC legal advisor, the Resale by the Selling Securityholders is not subject to the filing requirements prescribed in the Trial Administrative Measures for Overseas Listing. However, given that the Trial Administrative Measures for Overseas Listing were recently promulgated, there remains substantial uncertainties as to their interpretation, application, and enforcement. See "Risk Factors — Risks Related to Doing Business in China — Recent regulatory development in China may exert more oversight and control over listing and offerings that are conducted overseas. The approval, filing and/or other requirements of PRC governmental authorities may be required under PRC laws, regulations or policies" and "Business — Regulations — Laws and Regulations in China — Regulations relating to overseas listing."

For additional detail on these and other risks, see "Risk Factors — Risks Related to Doing Business in China" beginning on page 59 of this prospectus.

Risks Related to Ownership of the Ordinary Shares

In addition to the risks described above, holders of Ordinary Shares are also subject to general risks relating to such shares, including, but not limited to, the following:

- The price of the Ordinary Shares may be volatile, and the value of the Ordinary Shares may continue to decline.
- YS Biopharma is an emerging growth company and may take advantage of certain reduced reporting requirements.

- YS Biopharma is a foreign private issuer within the meaning of the rules under the Exchange Act, and as such YS Biopharma is exempt from certain provisions applicable to U.S. domestic public companies.
- If YS Group fails to remediate its material weakness and implement and maintain an effective system of internal control over financial reporting, YS Group may be unable to accurately report its results of operations, meet its reporting obligations or prevent fraud.
- Sales of the Ordinary Shares, or the perception of such sales, by YS Biopharma or the Selling Securityholders pursuant to this prospectus in the public market or otherwise could cause the market price for the Ordinary Shares to decline.

For additional details on these and other risks, see “Risk Factors — Risks Related to Ownership of the Ordinary Shares” beginning on page 73 of this prospectus.

Holding Company Structure

YS Biopharma is a holding company with no business operations of its own. YS Biopharma conducts a substantial portion of its business and operations through its PRC subsidiaries, in particular, Liaoning Yisheng and Beijing Yisheng, and a substantial portion of its assets are located in China. As a result, its ability to pay dividends and to service any debt it may incur overseas largely depends upon dividends paid by its subsidiaries. If its subsidiaries incur debt on their own behalf in the future, the instruments governing their debt may restrict their ability to pay dividends to YS Biopharma.

In addition, YS Biopharma’s subsidiaries in China are permitted to pay dividends to their shareholder only out of their after-tax profit, if any, as determined in accordance with the Accounting Standards for Business Enterprise as promulgated by the Ministry of Finance of the PRC (the “PRC GAAP”). The aggregate Accumulated Deficit for YS Biopharma’s PRC subsidiaries as determined under the Accounting Standards for Business Enterprise were RMB582.0 million, RMB515.7 million (\$75.1 million) and RMB581.3 million (\$81.0 million) as of March 31, 2022 and 2023 and September 30, 2023, respectively. In addition, pursuant to the relevant PRC laws, enterprises in the PRC have to make appropriation from their after-tax profit, as determined under PRC GAAP, to statutory common reserve funds. The appropriation to the statutory common reserve fund must be at least 10% of the after-tax profits calculated in accordance with PRC GAAP. Appropriation is not required if the reserve fund has reached 50% of the registered capital of such PRC enterprise. See “Business — Regulations” for a detailed discussion of the PRC legal restrictions on dividends and its ability to transfer cash within its group. In addition, holders of YS Biopharma’s securities may potentially be subject to PRC taxes on dividends paid by it in the event YS Biopharma is deemed as a PRC resident enterprise for PRC tax purposes. See “Material Taxation Consideration — Material PRC Tax Considerations” for more details.

None of YS Biopharma’s PRC subsidiaries have issued any dividends or distributions to respective holding companies, including YS Biopharma, or any investors as of the date of this prospectus. YS Biopharma’s subsidiaries in the PRC generate and retain cash generated from operating activities and re-invest it in its business. Historically, YS Biopharma has also received equity financing from its shareholders to fund business operations of YS Biopharma’s PRC subsidiaries. In the fiscal year ended March 31, 2021, 2022 and 2023 and the six months ended September 30, 2023, YS Biopharma transferred cash proceeds to Liaoning Yisheng in the amount of RMB428.5 million, RMB291.1 million, nil and nil, respectively. In the six months ended September 30, 2023, YS Biopharma transferred cash proceeds of RMB7.2 million to Beijing Yisheng. In the future, cash proceeds raised from overseas financing activities may be transferred by YS Biopharma through its subsidiaries outside China to its PRC subsidiaries via capital contribution and shareholder loans, as the case may be. YS Biopharma’s PRC subsidiaries will pay dividends to their offshore shareholder to meet the capital needs of YS Biopharma’s business operations out of the PRC. For details about the applicable PRC regulations and rules relating to such cash transfers through YS Group and the associated risks, see “Risk Factors — Risks Related to Doing Business in China.”

Cash is transferred among YS Biopharma, its offshore subsidiaries and its PRC subsidiaries, in the following manner: (1) funds are transferred to its PRC subsidiaries from YS Biopharma as needed through YS Biopharma’s subsidiaries outside China as capital contributions or shareholder loans, as the case may be; and (2) dividends or other distributions may be paid by its PRC subsidiaries to the Company through its subsidiaries outside China. YS Biopharma’s subsidiaries in the PRC generate and retain cash generated from operating activities and re-invest it in its business. None of its subsidiaries outside China made distributions to shareholders. In the future, YS Biopharma’s ability to pay dividends,

if any, to its shareholders and warrant holders and to service any debt it may incur will depend upon dividends paid by its subsidiaries. In the fiscal year ended March 31, 2021, 2022 and 2023 and the six months ended September 30, 2023, YS Group did not transfer any cash proceeds to any of its PRC subsidiaries except for the cash transfers within its Group in connection with the paid-in capital in its PRC subsidiaries. \$59,900,000 of the registered capital was paid up by HK Yisheng to Liaoning Yisheng during the fiscal year ended March 31, 2021 and \$45,099,071.49 of the registered capital was paid up by HK Yisheng to Liaoning Yisheng during the fiscal year ended March 31, 2022. In the fiscal year ended March 31, 2023, no registered capital was paid up by HK Yisheng to Liaoning Yisheng. In the six months ended September 30, 2023, \$1,008,767.58 of the registered capital was paid up by HK Yisheng to Beijing Yisheng.

Emerging Growth Company

YS Biopharma is an “emerging growth company” as defined in the JOBS Act. YS Biopharma will remain an “emerging growth company” until the earliest to occur of (1) the last day of the fiscal year (i) following the fifth anniversary of the closing of the Business Combination, (ii) in which YS Biopharma has total annual gross revenue of at least \$1.235 billion or (iii) in which YS Biopharma is deemed to be a large accelerated filer, which means the market value of the shares of YS Biopharma held by non-affiliates exceeds \$700 million as of the last business day of YS Biopharma’s prior second fiscal quarter, YS Biopharma has been subject to Exchange Act reporting requirements for at least 12 calendar months; and filed at least one annual report, and (2) the date on which YS Biopharma issued more than \$1.0 billion in non-convertible debt during the prior three-year period. YS Biopharma intends to take advantage of exemptions from various reporting requirements that are applicable to most other public companies, whether or not they are classified as “emerging growth companies,” including, but not limited to, an exemption from the provisions of Section 404(b) of the Sarbanes-Oxley Act requiring that YS Biopharma’s independent registered public accounting firm provide an attestation report on the effectiveness of its internal control over financial reporting and reduced disclosure obligations regarding executive compensation.

In addition, YS Biopharma has elected not to opt out of such extended transition period, which means that when a standard is issued or revised and it has different application dates for public or private companies, YS Biopharma, as an emerging growth company, can adopt the new or revised standard at the time private companies adopt the new or revised standard. This may make comparison of YS Biopharma’s financial statements with certain other public companies difficult or impossible because of the potential differences in accounting standards used.

Foreign Private Issuer

YS Biopharma is a foreign private issuer within the meaning of the rules under the Exchange Act and, as such, YS Biopharma is permitted to follow the corporate governance practices of its home country, the Cayman Islands, in lieu of the corporate governance standards of Nasdaq applicable to U.S. domestic companies. For example, YS Biopharma is not required to have a majority of the board consisting of independent directors nor have a compensation committee or a nominating and corporate governance committee consisting entirely of independent directors. YS Biopharma intends to follow its home country’s corporate governance practices as long as it remains a foreign private issuer. As a result, YS Biopharma’s shareholders may not have the same protection afforded to shareholders of U.S. domestic companies that are subject to Nasdaq corporate governance requirements. As a foreign private issuer, YS Biopharma is also subject to reduced disclosure requirements and are exempt from certain provisions of the U.S. securities rules and regulations applicable to U.S. domestic issuers such as the rules regulating solicitation of proxies and certain insider reporting and short-swing profit rules.

Controlled Company

YS Biopharma is a “controlled company” within the meaning of the Nasdaq corporate governance rules because Mr. Yi Zhang beneficially controls more than 50% of the total voting power of all issued and outstanding Ordinary Shares through the acting-in-concert arrangement under the Concert Party Agreement. See “Major Shareholders and Related Party Transactions — Concert Party Agreement” for details. As a result, Mr. Yi Zhang has the ability to exercise significant influence over matters requiring approval by shareholders such as election of directors and other significant corporate actions. Under the Nasdaq corporate governance rules, YS Biopharma may elect not to comply with certain corporate governance rules, including the requirements: (1) that a majority of YS Biopharma’s board of directors must consist of independent directors, (2) YS Biopharma’s director nominees must be selected or recommended to the board of directors solely by independent directors or by a nominations committee that is comprised entirely of independent directors and (3) that YS Biopharma’s Board must have a compensation committee

that is comprised entirely of independent directors. YS Biopharma does not currently plan to utilize the exemptions available for controlled companies, but instead, it intends to rely on the exemption available for foreign private issuers to follow its home country governance practices. As a result, you will not have the same protection afforded to shareholders of companies that are subject to these corporate governance requirements. For details, see the sections entitled “Risk Factors — Risks Related to Ownership of the Ordinary Shares — As an exempted company incorporated in the Cayman Islands, YS Biopharma is permitted to adopt certain home country practices in relation to corporate governance matters that differ significantly from Nasdaq’s corporate governance requirements; these practices may afford less protection to shareholders. If YS Biopharma opts to rely on such exemptions in the future, such decision might afford less protection to holders of YS Biopharma’s ordinary shares” and “Risk Factors — Risks Related to Ownership of the Ordinary Shares — YS Biopharma is a ‘controlled company’ within the meaning of the Nasdaq Stock Market listing rules and, as a result, may rely on exemptions from certain corporate governance requirements that provide protection to shareholders of other companies.”

THE OFFERING

The summary below describes the principal terms of the offering. The "Description of Share Capital" section of this prospectus contains a more detailed description of the Ordinary Shares.

Securities being registered for resale by the Selling Securityholders named in the prospectus	Up to 24,130,762 Ordinary Shares;
Offering prices	The securities offered by this prospectus may be offered and sold at prevailing market prices, privately negotiated prices or such other prices as the Selling Securityholders may determine. See "Plan of Distribution."
Ordinary shares issued and outstanding prior to any exercise of Warrants	93,058,197 Ordinary Shares
Warrants issued and outstanding	16,750,000 Warrants
Use of proceeds	All of the securities offered by the Selling Securityholders pursuant to this prospectus will be sold by the Selling Securityholders for their respective accounts. We will not receive any of the proceeds from such sales.
Dividend Policy	We have never declared or paid any cash dividend on our Ordinary Shares. We currently intend to retain any future earnings and do not expect to pay any dividends in the foreseeable future. Any further determination to pay dividends on our ordinary shares would be at the discretion of our board of directors, subject to applicable laws, and would depend on our financial condition, results of operations, capital requirements, general business conditions, and other factors that our board of directors may deem relevant.
Lock-up arrangement	The securities being registered for resale by the Selling Securityholders named in the prospectus are subject to 180 days lock-up period from March 16, 2023. The lockup requirements will cease to apply after the date on which the closing price of the Ordinary Shares equals or exceeds \$12.00 per share for any 20 trading days within any 30 trading day period commencing at least 150 days after March 16, 2023.
Market for our Ordinary Shares and Warrants	Our Ordinary Shares and Warrants are listed on Nasdaq under the trading symbols "YS" and "YSBPW," respectively.
Risk factors	Prospective investors should carefully consider the "Risk Factors" for a discussion of certain factors that should be considered before buying the securities offered hereby.

RISK FACTORS

An investment in YS Biopharma's securities involves a high degree of risk. You should carefully consider the following risk factors, together with all of the other information included in this prospectus, before making an investment decision. Certain of the following risk factors apply to the business and operations of YS Group and will also apply to the business and operations of YS Group. The occurrence of one or more of the events or circumstances described in these risk factors, alone or in combination with other events or circumstances, may have a material adverse effect on the business, financial condition, results of operations, prospects and trading price of YS Biopharma. The risks discussed below may not prove to be exhaustive and are based on certain assumptions made by YS Biopharma and YS Group, which later may prove to be incorrect or incomplete. YS Biopharma and YS Group may face additional risks and uncertainties that are not presently known to them, or that are currently deemed immaterial, but which may also ultimately have an adverse effect on any such party.

Risks Related to YS Group's Business and Products

Risks Related to YS Group's Marketed Product

YS Group depends on its current marketed rabies vaccine product to generate substantially all of its revenue in the near term. YS Group's previous operating history of manufacturing and commercializing vaccines may not provide an adequate basis to judge the viability of its business, the effectiveness of its management and its future profitability and prospects in respect of its marketed product.

YS Group currently owns one marketed product in China, its YSJATM rabies vaccine, sales of which have generated and are expected to continue to generate substantially all of YS Group's revenue in the near term. In the fiscal years ended March 31, 2021, 2022 and 2023 and the six months ended September 30, 2023, revenues from sales of rabies vaccine accounted for approximately 100% of the total revenues of YS Group. Its ability to continuously commercialize YSJATM rabies vaccine and expand its sales will depend on various factors, including, among other things, its ability to maintain proper manufacturing facilities, achieve effective sales and marketing, maintain competitive attractiveness, secure widespread acceptance of this product, maintain compliance with ongoing regulatory requirement, properly price and obtain coverage and adequate reimbursement of this product by governmental authorities, private health insurers and other third-party payors. If YSJATM rabies vaccine fails to achieve successful sales and further sales expansion, it could have a material adverse effect on the business, financial condition and results of operations of YS Group.

The vaccine's manufacturing processes, labeling, packaging, distribution, adverse event reporting, storage, advertising, promotion, sampling, recordkeeping, and post-marketing studies for its products are subject to extensive and ongoing regulatory requirements. These requirements include submissions of safety and other post-marketing information and reports, registration, and continued compliance with the Good Manufacturing Practice and the Good Clinical Practice. As of the date of this prospectus, YS Group manufactures YSJATM rabies vaccine in its GMP-compliant plant in Shenyang, China. If YS Group intends to build up new plants, or if the existing license for its current plant expires or is withdrawn, YS Group will be required to apply for new license or renew its current license for future production, which may disrupt the production and commercialization plan of YSJATM rabies vaccine. In addition, each lot release of the rabies vaccine produced by YS Group is subject to the inspection and pre-approval by relevant regulatory authorities before it enters into the market for sale. Any regulatory approvals YS Group receives for its products are also subject to certain market limitations, approval conditions or post-market testing requirements. Any government investigation of alleged violations of relevant laws and regulations could generate negative publicity and subject YS Group to additional compliance costs. Moreover, regulatory policies may change or additional government regulations may be enacted that could prevent, limit or delay regulatory approval. If YS Group is not able to maintain regulatory compliance, regulatory approval that has been obtained may be lost and it may not achieve or sustain profitability, which may significantly harm YS Group's business, financial condition, results of operations and prospects.

In addition, YS Group's previous operating history may not be indicative of its growth in business and revenue in the future. There may also be a decrease in demand, pricing or supply for its marketed product. Factors that could lead to such decline include, among others, increased competition, new product introductions, government-imposed pricing constraints, intellectual property issues, disruptions in manufacturing or distribution, and newly discovered safety issues. Any difference between YS Group's expected sales and the actual sales for its marketed product could materially and adversely affect YS Group's business, financial condition, results of operations and prospects.

YS Group faces substantial competition. Its competitors may discover, develop or commercialize products before, or more successfully than, YS Group do, or develop therapies that are more advanced or effective than YS Biopharma's, which may adversely affect YS Group's financial condition and its ability to successfully market or commercialize its marketed product and product candidates.

YS Group faces substantial competition with its marketed product, YSJA™ rabies vaccine, and product candidates, including PIKA rabies vaccine. Moreover, the development and commercialization of new products is also highly competitive. YS Group faces competition with respect to its existing product candidates, and will face competition with respect to any product candidates that YS Group may seek to develop or commercialize, from major pharmaceutical companies, specialty pharmaceutical companies and biotechnology companies worldwide. Competitors of YS Group's product and product candidates include vaccines, cell-based immuno-oncology therapies, checkpoint inhibitors and other immunological biologics. Potential competitors also include academic institutions, government agencies and other public and private research organizations and companies that conduct research, seek patent protection and establish collaborative arrangements for research, development, manufacture and commercialization. Specifically, there are a large number of companies, including many major pharmaceutical and biotechnology companies, that develop or market treatments for infectious diseases and immuno-oncology drugs.

Many of the companies against which YS Group is competing or may compete in the future have significantly greater financial resources and expertise in R&D, manufacturing, preclinical testing, conducting clinical trials, obtaining regulatory approvals and marketing approved products than YS Group does. These competitors also compete with YS Group in recruiting and retaining qualified scientific and management personnel and establishing clinical trial sites and patient registration for clinical trials, as well as in acquiring technologies complementary to, or necessary for, YS Group's marketed product and product candidates. New competitors, domestic or foreign, may also enter into the markets in which YS Group currently operates. Accordingly, YS Group may not be able to outperform a competing product for any number of reasons, including:

- the competing product may be, or may be perceived to be, more effective, safer or otherwise superior in quality or brand recognition;
- the competing product was introduced to the market earlier or gained wide market acceptance;
- the competing product incorporates more recent technological innovations or research findings;
- the competitor may have greater access to certain raw materials;
- the competitor may have more efficient manufacturing processes, greater manufacturing capacity or lower manufacturing costs;
- the competitors may develop and commercialize products that are safer, more effective, have fewer or less severe side effects, are more user-friendly or are less expensive;
- the competitors may have stronger relationships or a more established history with regulatory bodies, and may obtain regulatory approval for their products more rapidly;
- the competitor may have more aggressive marketing strategies, greater marketing capabilities or pricing flexibility;
- the competing product might be protected by robust patent protections or enjoy market exclusivity;
- the competitor might have more extensive distribution networks or strategic partnerships; or
- the competitor may have established a stronger reputation and a higher degree of trust with customers, and may provide a more superior customer service and support.

The technologies used in YS Group's industry are evolving rapidly, and new developments frequently result in price competition and product obsolescence. Additionally, technologies developed by competitors may render YS Group's marketed product and product candidates uneconomical or obsolete, and YS Group may not be successful in marketing its marketed product and product candidates against competitors. In addition, YS Group may be impacted by competition from substitute products. If YS Group is unable to compete effectively, it may lose market share

[Table of Contents](#)

and its financial performance may deteriorate. The availability of YS Group's competitors' products could limit the demand, the market share, the price YS Group is able to charge, and the strategic opportunities for partnerships and collaborations for any products that YS Group may develop and commercialize.

YS Group's product candidates, once commercialized, may compete with its existing marketed product.

YS Group is producing and selling YSJA™ rabies vaccine, which is a conventional rabies vaccine product. YS Group is also developing PIKA rabies vaccine, which is a rabies vaccine featuring an accelerated regimen. Given the potential advantages of PIKA rabies vaccine over conventional products, YS Group intends to formulate a premium pricing strategy to differentiate it from conventional products, including YSJA™ rabies vaccine. Nevertheless, once PIKA rabies vaccine enters into the market, it may compete with YSJA™ rabies vaccine in, among others, customer acquisition, market position and commercialization resources, which may hinder the sales performance and growth of YSJA™ rabies vaccine. In addition, the growth potential and market position of PIKA rabies vaccines may also be affected by the presence and growth of YSJA™ rabies vaccine. The competition between YS Group's marketed product and any product candidate may also impose a burden on its internal resources, disrupt its cost structure and reduce its operating efficiency. As a result, YS Group's prospects and results of operations may be materially and adversely affected.

If the rabies vaccine industry in China does not grow as expected or declines, YS Group's ability to expand its business and results of operations could be materially and adversely affected.

The rabies vaccine industry in China has developed rapidly in the past decade, driven by favorable government policies, GDP growth, increase awareness on public health, affordability of vaccination and the emergence of new virus and pandemics, according to the F&S report. However, the continued growth of the rabies vaccine industry will depend on numerous factors, many of which are beyond YS Group's control, including but not limited to:

- development, safety and efficacy, availability and affordability of alternative therapeutics;
- perception, recognition and acceptance of vaccines by end-users, CDCs, KOLs and others related to the vaccine or disease prevention industry;
- technological and scientific advancements, as well as manufacturing, storage and transportation techniques related to vaccines;
- general awareness on public health;
- changes in demographic composition and structure;
- changes in the regulatory environment, government policy and utilization of resources on public health matters;
- changes in insurance coverage of insurance companies and government programs;
- the occurrence of global health crises; and
- the general economic condition in China and globally.

Any decline or slowdown in the growth of the vaccine industry could materially and adversely affect YS Group's ability to expand its business and generate positive operating results.

The commercial success of any of YS Group's marketed product and product candidates depends on its degree of market acceptance by end-users, CDCs, KOLs and others related to the vaccine or disease prevention industry.

If end-users, CDCs, KOLs and others related to the vaccine or disease prevention industry do not accept YS Group's marketed product or product candidates, YS Group may be unable to generate significant revenue and may suffer losses. For example, in China, substantially all vaccine products are sold to CDCs, which comprise substantially YS Group's entire customer base for YSJA™ rabies vaccine. YS Group cannot assure you that its vaccine or vaccine candidates will gain market acceptance among CDCs in China. CDCs may reduce or cease the purchases if the patients do not accept these products or KOLs do not recommend YS Group's products. Failure to gain market acceptance would limit YS Group's ability to generate revenue as well as materially reduce its profitability.

[Table of Contents](#)

In particular, CDCs and their physicians may elect not to recommend YS Group's products to patients for a variety of reasons, including the reimbursement policies of government and third-party payers, as well as the willingness of patients to pay out-of-pocket in the absence of such coverage reimbursement. There are other vaccines for the medical conditions that YS Group's marketed product and product candidates target. In order to successfully launch a product, CDCs' physicians and patients must be educated about the relative benefits and advantages of YS Group's products over alternative products. If YS Group's products (including product candidates once commercialized) are not perceived to be user-friendly, present a lesser risk of side effects, or be more efficient or otherwise significantly better than other available products, YS Group's products may not be recommended or adopted by customers and end-users. A failure of YS Group's products to gain sufficient commercial acceptance would have a material adverse effect on its business, financial condition and results of operations. Even if YS Group's products achieve market acceptance, YS Group may not be able to maintain that market acceptance over time if new products or technologies are introduced that are more favorably received than its products, are more cost effective or render its products obsolete.

If YS Group's marketed product and product candidates as well as the related manufacturing, storage, testing, delivery and other procedures do not meet the required quality standards, YS Group's business and reputation could be harmed, and its revenue and profitability could be materially and adversely affected.

YS Group's marketed product and product candidates as well as the related manufacturing, storage, testing, delivery and other procedures are required to meet certain quality standards to ensure product safety and efficacy. YS Group cannot assure you that its quality control and assurance system can provide adequate and comprehensive protection against the associated risks at all times. YS Group's quality control and assurance policies and procedures may suffer from design deficiencies or fail to account for all risks in the manufacturing, storage, testing, delivery and other procedures. In addition, YS Group's quality control and assurance personnel may fail to comprehend the related policies and procedures, or implement such in a stringent and consistent manner at all times. For example, YS Group halted production of its marketed product for certain months in 2013 to address contamination issues. Moreover, YS Group cannot eliminate the risk of all errors, defects or failure, whether they are attributable to YS Group or third parties. Quality defects may be attributable to a number of reasons, including:

- manmade or naturally occurring errors and imprecision in the manufacturing, storage, testing, delivery and other procedures;
- technical or mechanical malfunctions in the manufacturing, storage, testing, delivery and other procedures;
- human error or malfeasance by YS Group's quality control, quality assurance, manufacturing, experiment and other personnel, as well as other responsible personnel of third parties;
- tampering or interference by external entities or third parties;
- use of outdated or poorly maintained equipment or technology;
- insufficient or ineffective quality control systems;
- non-compliance or negligence of regulatory guidelines by third-party collaborators, suppliers or vendors;
- exposure to suboptimal manufacturing, storage, testing and delivery conditions or environment; and
- quality issues with the raw materials and consumables YS Group purchases or produce.

Failure to detect and cure quality defects in YS Group's vaccine products or to prevent such defective products from being delivered to end-users could result in patient injury or death, product recalls or withdrawals, license suspension or revocation, government investigations, legal actions, regulatory fines, increased cost, potential difficulties in future approvals, or negative media coverage that could damage YS Group's reputation and business, expose YS Group to liability, and materially and adversely affect its revenue and profitability.

YS Group's business may be materially and adversely affected by product recalls or defects in the biopharmaceutical industry, and any other scandals and incidents that negatively affect the reputation and public perception of the vaccine industry as a whole.

Both the manufacturing and distribution processes of biopharmaceutical products are complex. In addition, biopharmaceutical products must be stored properly to remain safe and effective. In the past, major biopharmaceutical

[Table of Contents](#)

companies had instances of product recalls due to product defects. Such recalls have in the past been subject to widespread media attention. Such recalls could damage both the reputation of major biopharmaceutical manufacturers, as well as the biopharmaceutical industry as a whole. In addition, there have been scandals of poor handling of production of biopharmaceutical products by certain companies. For example, in 2018, the Changchun Changsheng vaccine scandal in China caused widespread outrage where China's second largest rabies vaccine manufacturer allegedly violated GMP manufacturing protocols and regulations, which resulted in the production of defective vaccines.

Such incidents have caused, and any future similar incidents and any negative publicity regarding the biopharmaceutical industry could cause, reputational damage to the biopharmaceutical industry and could reduce demand for biopharmaceutical products by creating negative public perception of vaccines. In addition, the government may promulgate new regulations and rules to reform, strengthen or change the existing supervision over the vaccine industry. If any of such event occurs, YS Group's business, financial condition and results of operations could be materially and adversely affected.

YS Group's marketed product and product candidates may cause undesirable adverse events or have other properties that could delay or prevent their regulatory approval, limit the commercial profile of an approved label, or result in disputes, claims, litigations or other significant negative consequences following any regulatory approval.

Undesirable adverse events caused by YS Group's product candidates could cause YS Group or regulatory authorities to interrupt, delay or halt clinical trials and could result in a more restrictive label or the delay or denial of regulatory approval by the National Medical Products Administration (the "NMPA") in China, Health Sciences Authority (the "HSA") in Singapore, U.S. Food and Drug Administration (the "FDA") or other comparable regulatory authorities. Results of YS Group's trials could reveal a high and unacceptable severity or prevalence of adverse events, which could cause the suspension or termination of such trials, or the cessation of development and the denial of approval from relevant regulatory authorities. Undesirable adverse events caused by its products or product candidates may include but are not limited to, inflammatory response of certain organs. As most of YS Group's product candidates have not been testified in large-scale clinical trials, the adverse effect of such, especially that of long-term use, are uncertain. Certain types of disease may also not respond to YS Group's product candidates. In addition, combination therapy with other marketed products may cause uncertain adverse effect. Product-related adverse events could affect patient recruitment and the ability of enrolled subjects to complete the trial, and could result in potential product liability claims. Additionally, undesirable side effects or adverse events caused by or relating to YS Group's marketed product or product candidates may be discovered after they receive regulatory approval. Potential product liability is also a significant risk for biopharmaceutical companies, given that liability claims common in YS Group's industry are hard to foresee by nature. Such claims can also lead to product recalls, withdrawals, or declining sales, and/or be accompanied by consumer fraud claims by customers, third-party payers seeking reimbursement of the cost of YS Group could be sued and held liable for the adverse events caused to subjects in clinical trials or patients and the relevant compensation, regardless whether a causal relationship can be proven; regulatory authorities may withdraw approvals of the product; YS Group is subject to regulatory seizure of its products; regulatory authorities may require additional warnings on the label; product and/or other claims, including potential civil or criminal governmental actions. Any of these occurrences may harm YS Group's reputation, business, financial condition and prospects significantly.

YS Group has become, and may continue to become subject to such negative events and consequences, including but not limited to the following:

- YS Group could be sued and held liable for adverse events to subjects in clinical trials or patients and the relevant compensation, regardless of whether a causal relationship can be proven;
- YS Group may suspend commercialization and marketing of the product;
- regulatory authorities may withdraw approvals of the product;
- YS Group is subject to regulatory seizure of its products;
- regulatory authorities may require additional warnings on the label;
- YS Group may be required to develop risk evaluation and mitigation strategies for the product, to incorporate additional requirements under such strategies, or to develop a similar strategy as required by a comparable regulatory authority;

[Table of Contents](#)

- YS Group may propose to or be required to conduct postmarket studies; and
- YS Group could be prevented from achieving market acceptance of the particular product.

The recession or eradication of the infectious diseases that YS Group's vaccines target may adversely affect its sales.

YS Group devoted significant resources to the R&D of vaccines against infectious diseases, and will continue to devote resources to the development of vaccines for novel infectious diseases. However, a pandemic or type of infectious disease may have receded before YS Group realizes any return on its investment in the R&D of its vaccines. Moreover, diseases that YS Group's vaccines target may be eradicated, which would eliminate the market of YS Group's vaccines. In addition, outbreaks of infectious diseases may cause CDCs to increase their purchases of vaccines against the pandemic diseases and reduce purchases of other vaccines in a short period. Changes of the procurement plans of CDCs could adversely affect sales of YS Group's vaccine products.

Risks Related to the Development of YS Group's Product Candidates

YS Group's success depends substantially on the success of its product candidates in preclinical or clinical trial stages. Preclinical or clinical trials involve a lengthy and expensive process with uncertain outcomes. YS Group may not be able to achieve its projected development goal of its product candidates in a timely manner or at all, which may materially and adversely affect YS Group's business, financial condition, results of operations and prospects.

YS Group's business success will substantially depend on the successful development, regulatory approval and commercialization of its product candidates, particularly its lead product candidates, such as PIKA rabies vaccine, PIKA recombinant COVID-19 vaccine and PIKA YS-ON-001. These product candidates are still in preclinical or clinical studies. Before YS Group can generate revenue from sales of these product candidates, each of them will undergo the process of preclinical and/or clinical studies, regulatory approval in multiple jurisdictions, development of manufacturing supply and capacity, substantial investment and significant marketing efforts. YS Group invested a significant portion of its efforts and financial resources in the development of its existing lead product candidates, and will continue to evaluate the progress and prioritization of its product candidates and relying on third parties to manage and conduct high-quality clinical trials safely and efficiently; make further investment based on its evaluation, aligning with its financial condition, global health needs and market dynamics. The success of YS Group's product candidates will depend on several factors, including:

- successfully enrolling and/or completing preclinical studies and clinical trials, as well as other studies required to obtain regulatory approval;
- obtaining regulatory approvals from applicable regulatory authorities for planned clinical trials, future clinical trials or product registrations, manufacturing and commercialization;
- establishing commercial manufacturing capabilities, either by building facilities itself or making arrangements with third-party manufacturers;
- adequate fiscal support, technical proficiency and the ability to consistently obtain high-quality raw materials crucial to the implementation of preclinical studies, clinical trials, manufacturing processes, and commercialization;
- relying on third parties to manage and conduct high-quality clinical trials safely and efficiently;
- obtaining and maintaining patent, trade secret and other intellectual property protection and regulatory exclusivity;
- ensuring that YS Group does not infringe, misappropriate or otherwise violate the patent, trade secret or other intellectual property rights of third parties;
- commercializing YS Group's product candidates;
- obtaining reimbursement from third-party payers for product candidates;
- obtaining and maintaining healthcare coverage and adequate reimbursement;

[Table of Contents](#)

- competing with other products and product candidates in the market;
- successfully enforcing and defending intellectual property rights and claims; and
- achieving continued acceptable safety profile for YS Group's product candidates following regulatory approval.

As a publicly listed company, YS Group may continue to make such disclosures of its expectations in this respect. Notably, the progression of each product candidate is not only subject to its individual performance, but also YS Group's prioritization assessment and the relative advancement and potential of YS Group's entire portfolio. Thus, priority may be shifted between product candidates based on their comparative outlooks, which might impact the achievement of development milestones for individual candidates. The actual timing for achieving product development milestones could vary significantly from YS Group's expectations due to a number of factors, many of which are outside its control. There can be no assurance that YS Group's preclinical studies or clinical trials will be completed as planned or at all, or that YS Group will make regulatory submissions or receive regulatory approvals as planned, or that YS Group will be able to adhere to its current schedule for the launch of any of its products candidates. If YS Group fails to achieve one or more of these milestones as planned, it could adversely affect the price of its Shares and its business prospects.

Preclinical and clinical studies involve a lengthy and expensive process with an uncertain outcome. YS Group may incur additional costs or experience delays, halts or failures in completing preclinical or clinical studies, or ultimately be unable to complete the development and commercialization of YS Group's product candidates.

Before obtaining regulatory approval for the sale of YS Group's product candidates, YS Group must conduct extensive preclinical and clinical studies to demonstrate the safety and efficacy of its product candidates in non-human and human subjects. Clinical testing is expensive, difficult to implement, can take many years to complete, and is uncertain as to the outcome. A failure of one or more of YS Group's clinical trials can occur at any stage of testing. The outcome of preclinical testing and early clinical trials may not be predictive of the success of later clinical trials, and successful interim results of a clinical trial do not necessarily predict successful final results. Moreover, preclinical and clinical data are often susceptible to varying interpretations and analyses. YS Group may nonetheless fail to obtain regulatory approval of its product candidates dependent solely on the discretion of each regulatory body.

YS Group may experience delays, halts or failures in completing its preclinical or clinical studies and numerous unforeseen events could arise during, or as a result of, future clinical trials, which could delay or prevent YS Group from receiving regulatory approval of its product candidates. These factors include:

- regulators, institutional review boards ("IRBs"), or ethics committees may not authorize YS Group or its investigators to commence or conduct a clinical trial at a prospective trial site;
- regulatory authorities may disagree with or change their position on the acceptability of YS Group's trial designs or clinical endpoints;
- clinical trials may produce negative or inconclusive results, which could cause YS Group to conduct additional clinical trials or abandon product development programs;
- the number of patients required for clinical trials of YS Group's product candidates may be larger than it anticipates, enrollment in these clinical trials may be slower than it anticipates or participants may drop out of these clinical trials or fail to return for post-treatment follow-up at a higher rate than it anticipates;
- third-party contractors used in YS Group's clinical trials may fail to comply with regulatory requirements or meet their contractual obligations in a timely manner, or at all, or may deviate from the clinical trial protocol or drop out of the trial, which may require that YS Group adds new clinical trial sites or investigators;
- clinical trial sites may withdraw from YS Group's clinical trials as a result of changing standards of care or the ineligibility of a site to participate in YS Group's clinical trials;
- YS Group may fail to identify and maintain a sufficient number of trial sites;

[Table of Contents](#)

- the ability to conduct a companion diagnostic test to identify patients who are likely to benefit from YS Group's product candidates;
- YS Group may elect, or be required to, suspend or terminate clinical research for various reasons, including non-compliance with regulatory requirements or a finding that participants are being exposed to unacceptable health risks;
- the cost of clinical trials of YS Group's product candidates may be greater than YS Group anticipates, and YS Group cannot obtain sufficient funds;
- the supply or quality of YS Group's product candidates or other materials necessary to conduct clinical trials of its product candidates may be insufficient or inadequate;
- YS Group's product candidates may have undesirable side effects or unexpected characteristics, causing the termination of such trials, or reports may arise from preclinical or clinical testing of other therapies that raise safety or efficacy concerns about YS Group's product candidates;
- YS Group may not complete preclinical or clinical trials as its originally scheduled;
- YS Group may encounter regulatory delays if a clinical trial is suspended or terminated due to various factors, including but not limited to a failure to conduct the clinical trial in accordance with regulatory requirements or the applicable clinical protocols, inspection of the clinical trial operations or trial site by regulatory authorities that results in the imposition of a clinical hold, unforeseen safety issues or adverse side effects, failure to demonstrate a benefit from using a product, changes in governmental regulations or administrative actions or lack of adequate funding to continue the clinical trial; and
- YS Group's preclinical and clinical studies may be hindered, delayed or prevented by the occurrence or influence of other incidents or negative events, such as the long-term effects of COVID-19 and the ongoing global health situation, as well as political conflicts between China and other countries.

Many of these factors that cause a delay, halt or failure in the commencement or completion of clinical trials may also ultimately lead to delay or denial of regulatory approval of YS Group's product candidates and increases in product development costs. Significant preclinical study or clinical trial delays also could allow YS Group's competitors to acquire more market shares, which may harm YS Group's ability to commercialize its product candidates and adversely affect YS Group's business and results of operations.

Results of earlier clinical trials may not be predictive of results of later-stage clinical trials.

The results of preclinical studies and early clinical trials of YS Group's product candidates may not be predictive of the results of later-stage clinical trials. Product candidates in later stages of clinical trials may fail to show the desired safety and efficacy traits despite having progressed through preclinical studies and initial clinical trials. Future clinical trial results may not be favorable for a variety of reasons. For example, there can be significant variability in safety and/or efficacy results between different trials of the same product candidate due to numerous factors, including changes in trial procedures set forth in protocols, differences in the size and type of the subject populations, including genetic and biological differences and other trial protocols. Various aspects of the development program, such as manufacturing and formulation, may be altered along the way in an effort to optimize processes and results. Such changes may not achieve these intended objectives or more compliance expenses. In the case of any trials YS Group conducts, results may differ from earlier trials due to the larger number of participants and resulting complexity due to the involvement of diversified demographics, as well as the large number of clinical trial sites and additional countries and languages involved in such trials. Any of these changes could make the results of planned clinical trials or other future clinical trials YS Group may initiate less predictable and could cause YS Group's product candidates to perform differently, which could require additional governmental communications and procedures for the altered clinical trial plan, delay the completion of clinical trials, delay approval of YS Group's product candidates and/or jeopardize YS Group's ability to commence commercialization of its product candidates.

If the targeted market for YS Group's product candidates does not grow as expected or declines, YS Group's ability to expand its business and results of operations could be materially and adversely affected.

The targeted markets for YS Group's product candidates, including, among others, the vaccine and infectious drug market in Southeast Asia and China are evolving, the continued growth of which will depend on numerous factors, many of which are beyond YS Group's control, including but not limited to:

- development, safety and efficacy, availability and affordability of alternative therapeutics;
- perception, recognition and acceptance of vaccines by end-users, CDCs, KOLs and others related to the vaccine or disease prevention industry;
- technological and scientific advancements, as well as manufacturing, storage and transportation techniques related to vaccines;
- general awareness on public health;
- changes in demographic composition and structure;
- changes in regulatory environment, government policy and utilization of resources on public health matters;
- changes in insurance coverage of insurance companies and government programs;
- the occurrence of global health crises;
- the general economic condition in China and globally.

Any decline or slowdown in the growth of the vaccine industry could materially and adversely affect YS Group's ability to expand its business and generate positive operating results.

YS Group may not be successful in its efforts to identify or discover additional product candidates. Due to YS Group's limited resources and access to capital, YS Group must, and have in the past decided to, prioritize the development of certain product candidates. These decisions may prove to have been wrong and may adversely affect YS Group's business.

YS Group intends to explore other biopharmaceutical opportunities in addition to YS Group's existing product candidates. However, YS Group may fail to identify other product candidates for clinical trials for a number of reasons, such as research methodology challenges, harmful side effects, changes in market trends, lack of access to necessary raw materials, the emergence of competitive products or certain regulatory requirement. There can be no assurance that YS Group will ever be able to identify additional biopharmaceutical opportunities for its product candidates or develop suitable potential product candidates.

If YS Group does not accurately evaluate the commercial potential or target market for a particular product candidate, YS Group may derive less value from that product candidate through collaboration, licensing or other royalty arrangements, as compared to retaining sole development and commercialization rights to such product candidate.

Because YS Group has limited financial and managerial resources, it must limit its licensing, R&D programs to specific product candidates that it identifies for specific indications. For example, YS Group has focused on developing its PIKA immunomodulating technology platform, which it believes has great potential to create a wide variety of innovative immunological biologics to address underserved medical needs in treating and preventing infectious diseases and cancer. However, YS Group may focus its efforts and resources on product candidates or other potential programs that ultimately prove to be unsuccessful or generate less return than expected, which may cause YS Group to forego or delay pursuit of more successfully product development opportunities. YS Group's resource allocation decisions may cause YS Group to fail to capitalize on viable products or profitable market opportunities.

YS Group may rely on third parties to monitor, support and/or conduct preclinical or clinical trials of its product candidates. If the preclinical and clinical trial organizations do not perform in an acceptable manner, YS Group may be unable to develop and commercialize its candidates as anticipated.

YS Group may rely on academic institutions, CROs, hospitals, clinics and other organizations and institutions, who are beyond YS Group's control, to monitor, support and conduct preclinical and/or clinical studies of its product candidates. As a result, YS Group has less control over the quality, timing and cost of these studies and the ability to recruit trial subjects than if it conducts these trials wholly by itself. If YS Group is unable to maintain or enter into agreements with these third parties on acceptable terms, or if any such engagement is terminated, YS Group may be unable to enroll subjects on a timely basis or otherwise conduct its trials in the manner it anticipates. In addition, there is no guarantee that these third parties will devote adequate time and resources to YS Group's studies or perform as required by a contract or in accordance with regulatory requirements, including maintenance of clinical trial information regarding YS Group's future product candidates. If these third parties fail to meet expected deadlines, timely transfer to YS Group any regulatory information, adhere to protocols or act in accordance with regulatory requirements or YS Group's agreements with them, or if they fail to comply with the confidentiality agreement, subcontract their obligations without YS Group's consent, or otherwise perform in a substandard manner or in a way that compromises the quality and/or accuracy of their activities and/or the data they obtain, then clinical trials of YS Group's future product candidates may be extended, delayed or terminated, or YS Group's data may be rejected by the NMPA, the HSA or other regulatory agencies.

Restrictions imposed by YS Group's outstanding indebtedness and any future indebtedness may limit YS Group's ability to operate its business and to finance its future operations or capital needs.

In March 2022, YS Group completed a \$40 million royalty-based 4.5-year long-term debt transaction with R-Bridge Investment Holdings Pte. Ltd. The terms of the loan facility limit YS Group's ability to, among other things, incur additional indebtedness, incur liens on YS Group's assets, engage in consolidations, mergers, liquidations, dissolutions, sell or otherwise dispose of YS Group's assets, acquire other businesses, make loans, capital contributions, or other investments, or enter into any other transactions outside of the ordinary course of business. In addition, YS Group is obliged to pay royalties based upon YS Group's annual Net Sales (as defined in the royalty deed dated March 16, 2022 entered into between HK Yisheng and R-Bridge Healthcare Fund, LP) by multiplying the applicable royalty rate by the corresponding amount incremental Net Sales for that financial year. The terms of YS Group's loan facilities and royalty obligations restrict YS Group's current and future operations and could adversely affect YS Group's ability to finance its future operations or capital needs or take advantage of financing opportunities, mergers, acquisitions, investments, and other corporate opportunities that may be beneficial to YS Group's business. In addition, complying with these covenants may make it more difficult for YS Group to successfully execute its business strategy and compete against companies which are not subject to such restrictions.

Risks Related to Extensive Government Regulations

The biopharmaceutical industry is highly regulated. The relevant regulations and policies are complex and regional and subject to changes from time to time. YS Group's ability to obtain and maintain these regulatory approvals is uncertain. Any change in government regulation and policy may place additional burdens on YS Group's business and have a material adverse effect on YS Group's financial condition and results of operations.

The biopharmaceutical industry is subject to extensive government regulation and supervision, which addresses all aspects of operations in the biopharmaceutical industry, including but not limited to approval, production, distribution, packaging, labeling, storage and shipment, advertising, licensing and certification requirements and procedures, periodic renewal and reassessment processes, registration of new drugs and environmental protection. For example, in order to manufacture and market any immunological biologics in China, a pharmaceutical company is required to obtain permits and certificates from the NMPA, including but not limited to the drug registration certificate (where applicable), the drug manufacturing license, and to pass the initial GMP inspections and continued compliance with the GMP, as well as other manufacturing requirements for its manufacturing facilities. The drug registration certificate and the drug manufacturing license are subject to renewal periodically. In addition, a vaccine manufacturer is also required to obtain lot release for each lot of vaccine products before they can be released to the market.

[Table of Contents](#)

The lot release step involves the supervisory and administrative system by which the NMPA designates a drug inspection institution to conduct document review, on-site verification and sample inspection in connection with vaccine products, blood products, in vitro diagnostics for blood screening, or any other biological products as described by the NMPA, before any batch of such products can be marketed or exported. The NMPA updated certain standards in the National Pharmacopoeia for human rabies vaccines in late 2020. In order to comply with such new standards, YS Group expects to spend more time to communicate with the competent authorities on the relevant testing methods and procedures before lot release approval.

Violation of applicable laws, rules and regulations by YS Group may lead to its failure to obtain or renew permits, licenses or approvals required for operation in a timely manner or on commercially reasonable terms. As a result, YS Group will not be able to engage in or have to suspend or cease the manufacture or sale of any products, which may have a material adverse effect on YS Group's business, financial condition, results of operations and prospects.

YS Group's ability to manufacture its marketed product and its future approved product candidates depends on its ability to develop, validate and maintain commercially viable manufacturing processes that are compliant with GMP regulations. For example, YS Group halted its production of marketed product for certain months in 2013 to address contamination issues. YS Group cannot assure you it will be able to maintain required certificates or continue to meet the GMP requirements by the drug regulatory authority, which may cause YS Group to suspend or terminate the manufacturing and commercialization of its marketed products, and materially and adversely affect its business, financial condition and results of operations.

The NMPA may also withdraw approval if compliance with regulatory requirements and standards is not maintained or if problems occur after YS Group's products reach the market. In addition, later discovery of previously unknown problems with YS Group's marketed product, including adverse events of unanticipated severity or frequency, or with YS Group's manufacturing processes, or failure to comply with regulatory requirements, may result in revisions to the approved labeling to add new safety information, imposition of post-market studies (including but not limited to clinical studies) to assess new safety risks, or imposition of distribution restrictions or other restrictions under a risk evaluation and mitigation program. YS Group cannot predict the likelihood, nature or extent of government regulation that may arise from future legislation or administrative action. If YS Group is slow or unable to adapt to changes in existing requirements or the adoption of new requirements or policies, or if YS Group is not able to maintain regulatory compliance, YS Group may lose any regulatory approval that it may have obtained and it may not achieve or sustain profitability.

In addition, regulatory requirements and approval process varies among countries, jurisdictions and regions, which may involve additional product testing and validation and additional administrative review periods. YS Group's product candidates may need to apply for and obtain approval from multiple jurisdictions where it plans to study or market the products, which may be costly and time-consuming. Even if product candidates successfully complete clinical trials in one country, there is no assurance that clinical trials of the same product conducted with patients in other countries will be successful. Moreover, any safety issues, product recalls or other incidents related to products approved and marketed in one jurisdiction may impact approval of those products in another jurisdiction. If YS Group is unable to obtain regulatory approval for its product candidates in one or more jurisdictions, or any approval contains significant limitations, or are imposed on certain product candidates, YS Group may not be able to obtain sufficient funding or generate sufficient revenue to continue the development of its product candidates or any other product candidate that it may in-license, acquire or develop in the future. The regulatory framework governing the biopharmaceutical industry is also subject to change and amendment from time to time. Any regulatory changes or amendment may materially and adversely impact YS Group's business, financial condition, results of operations and prospects.

YS Group's marketed product and product candidates may become subject to unfavorable pricing regulations, third-party reimbursement practices or healthcare reform initiatives, which could harm YS Group's business.

The regulations that govern regulatory approvals, pricing and reimbursement for new immunological biologics vary widely from country to country. YS Group might obtain regulatory approval for a drug in a particular country, but then be subject to price regulations that delay YS Group's commercial launch of the drug and negatively impact the revenues it is able to generate from the sale of the drug in that country. Adverse pricing limitations may hinder YS Group's ability to recoup its investment in its marketed product and/or one or more product candidates, even if they obtain regulatory approval. For example, according to Opinions on Reforming the Review and Approval System for Pharmaceutical Products and Medical Devices, issued by the State Council in August 2015, the enterprises applying

for drug approval in China will be required to undertake that the selling price of new drugs on the PRC market shall not be higher than the price of the product in its country of origin or the comparable market prices of the products in China's neighboring markets, as applicable.

YS Group's ability to commercialize any product successfully also depends in part on the extent to which reimbursement for such product and related treatments will be available from government health administration authorities, private health insurers and other organizations. Patients who are provided medical treatment for their conditions generally rely on third-party payers to reimburse all or part of the costs associated with their treatment. Government authorities and third-party payers, such as private health insurers and health maintenance organizations, decide which products and treatments they will cover and the amount of reimbursement, which is critical to the market acceptance of new products. There may be significant delays in obtaining reimbursement for approved product candidates, and coverage may be more limited than the purposes for which the product is approved by regulatory authorities. Moreover, eligibility for reimbursement does not imply that any product will be paid for in all cases or at a rate that covers YS Group's costs. Interim payments for new products, if applicable, may also not be sufficient to cover YS Group's costs and may not be made permanent. Payment rates and third-party payer coverage may be reduced for a number of commercial and regulatory reasons, all of which may adversely affect the commercialization of YS Group's marketed product or any product candidate.

As YS Group intends to seek approval to market its marketed product and product candidates in multiple jurisdictions, it will be subject to various rules and regulations regarding coverage and reimbursement. Moreover, eligibility for reimbursement in China, Singapore or other jurisdictions does not imply that any product will be paid for in all cases or at a rate that covers YS Group's costs, including licensing fees, research, development, manufacture, sale and distribution. Reimbursement rates may vary according to the use of the product and the clinical setting in which it is used, may be based on reimbursement levels already set for lower cost products and may be incorporated into existing payments for other services. Moreover, in many jurisdictions, the pricing of products and biologics is subject to governmental control. In these countries, pricing negotiations with governmental authorities can take considerable time after obtaining regulatory approval of a product candidate. As a result, net prices for products may be reduced by mandatory discounts or rebates required by government healthcare programs, or private payers in the case of third-party reimbursement.

YS Group's marketed product or product candidates may not be included in the list of products that can be reimbursed by mandatory medical insurance in China. YS Group cannot be sure that reimbursement will be available for any product that it commercializes and, if reimbursement is available, what the level of reimbursement will be. The price of rabies vaccine in China also increases significantly. Patients may be unlikely to use certain of YS Group's marketed product and product candidates if coverage is not provided and reimbursement is inadequate to cover a significant portion of the cost of such marketed product and product candidates. Because some of YS Group's marketed product and product candidates have a higher cost of goods than conventional therapies, and may require long-term follow-up evaluations, the risk that coverage and reimbursement rates may be inadequate for YS Group to achieve profitability may be greater. In addition, YS Group's inability to promptly obtain coverage and profitable payment rates from both government-funded and private payers for any approved products could have a material adverse effect on its results of operations, its ability to raise capital needed to commercialize product candidates and its overall financial condition. Obtaining reimbursement for YS Group's marketed product may be particularly difficult because of the higher prices often associated with products administered under the supervision of a physician. Therefore, the availability of third-party reimbursement may significantly impact the demand for, or the price of, any product for which YS Group obtains regulatory approval. If reimbursement is not available or is available only to limited levels, YS Group may not be able to successfully commercialize its marketed product or any product candidate that it successfully develops, which could have a material adverse effect on YS Group's results of operations, its ability to raise capital needed to commercialize product candidates and its financial condition.

YS Group may not be able to be successfully prequalified by province-level CDCs of its target provinces or secure subsequent product orders.

YS Group expects the county-level CDCs, to be its primary customers in China. YS Group is focused on China's private vaccine market, and substantially all of its marketed product and product candidates are required to be prequalified by province-level CDCs of YS Group's target provinces through a bidding process before undertaking any sales.

[Table of Contents](#)

The province-level CDCs usually select one or more suppliers for the same type of vaccine, taking into consideration, among other things, the quality and price of the products and the service and reputation of the suppliers. YS Group may be unsuccessful in winning bids in the tender process to prequalify its products at the provincial level. If YS Group fails to obtain the required prequalification, it will lose market share to its competitors, and YS Group's revenue and profitability will be adversely affected. Even if YS Group's vaccines are prequalified, YS Group cannot guarantee that it can maintain the standards and make continuous improvements to keep up with evolving market demands and regulations to achieve sustainability of the prequalification status, and neither can YS Group guarantee its ability to secure purchase orders from county-level CDCs. If CDCs do not purchase YS Group's products, or the purchase volume is lower than expected, its business, financial conditions and results of operations would be adversely affected.

YS Group's sales to CDCs subject YS Group to certain risks related to doing business with public authorities.

YS Group sells its vaccine products in China to CDCs and participate in public tenders hosted by them, which exposes YS Group to certain risks related to doing business with public authorities. For example, although YS Group signs contracts with them for sales of its vaccine products, and such contracts generally stipulate the payment time and method as well as dispute resolution, YS Group has little or no control over their procurement decisions or payment cycles, and the CDCs that contract to purchase YS Group's products may reduce or cancel orders, or demand price adjustments or other changes to their contracts with YS Group without its consent. Furthermore, YS Group may experience delays in payments from these CDCs due to bureaucratic processes, changes in governmental policies or budget constraints, which could impact its cash flow and financial condition. YS Group's participation and reliance on public tenders may also expose it to political changes and policy fluctuations, as the public health budget, regulatory guidelines, and the overall health care landscape may be influenced. For example, changes in the personnel of CDCs that purchase YS Group's products may result in changes or delays to, or cancellations of, their purchase commitments due to, among others, differing policy and budgetary agendas of the personnel involved. Furthermore, public tenders are typically highly competitive and governed by strict procurement regulations, which might lead to unpredictable outcomes and increased bidding costs. Any of the foregoing actions taken by the authorities could have a material adverse effect on YS Group's results of operations and expected earnings, or result in its failure to meet, or having to adjust downwards, its sales estimates.

In addition, many of the remedies that are available to YS Group when dealing with private parties, such as making claims for breach of contract or taking other legal actions, may not be practicable in YS Group's dealings with CDCs. YS Group's ability to seek legal remedies in instances of disputes with CDCs may be more limited than when interacting with private entities. For example, in the event of any dispute with a CDC, YS Group may find pursuing formal legal action against a CDC might not be the most viable or beneficial strategy due to potential reputational harm or the risk of straining future relationships. It may be in its best interest to, instead, resolve such disputes through other means, such as negotiations or third-party mediation. However, it should be noted that the outcomes of these alternatives may not be as or more advantageous and favorable to YS Group than those YS Group would have obtained from traditional formal legal proceedings.

YS Group has been involved, and may continue to be involved, in claims, disputes, litigation, arbitration or other legal and administrative proceedings in the ordinary course of business.

YS Group has been involved, and may continue to be involved, in claims, disputes, litigation, arbitration or other legal and administrative proceedings in its ordinary course of business. These may concern issues relating to, among others, quality issues relating to YS Group's marketed product and product candidates, the manufacturing, storage, logistics and commercialization processes relating to its marketed product and product candidates, administrative actions, authority, procedures and decisions, product liability, environmental matters, breach of contract, construction projects, employment or labor disputes, and infringement of intellectual property rights.

YS Group is not involved in any ongoing litigation or legal proceedings that could materially and adversely affect the commercialization and R&D of YS Group's product and product candidates, or its business and results of operations. However, YS Group cannot assure you that there will be no future disputes, litigation, arbitration, administrative investigation or other legal and administrative proceedings initiated by YS Group or brought against YS Group, with or without merit. YS Group may involve additional administrative proceedings against it or initiated by YS Group against the competent regulatory authorities to protect its legal rights and interests in the future. Any such claims, disputes or legal proceedings may result in substantial costs, disruption of YS Group's business operations, diversion of resources

[Table of Contents](#)

and material harm to YS Group's reputation. Furthermore, claims, disputes or legal proceedings against YS Group may be due to defective supplies sold to YS Group by YS Group's suppliers, who may not be able to indemnify YS Group in a timely manner, or at all, for any costs that YS Group incurs as a result of such claims, disputes and legal proceedings.

YS Group may not be able to manage its sales and marketing personnel effectively, and may consequently be subject to penalties pursuant to anti-corruption laws. YS Group's reputation, business, prospects and brand may be materially and adversely affected by actions taken by them.

YS Group is subject to anti-bribery laws in China that generally prohibit companies and their intermediaries from making payments, offering property or other illegal benefits to government officials for the purpose of obtaining or retaining business or securing any other improper advantage. Although YS Group has policies and procedures designed to ensure that its employees and its agents comply with anti-bribery laws, there is no assurance that such policies or procedures will prevent YS Group's agents, employees and intermediaries from engaging in bribery. For example, although YS Group's company policies prohibit employees from making improper payments to CDCs or otherwise engaging in improper activities to influence the procurement decisions of drug products by CDCs, YS Group may not be able to manage its sales and marketing employees effectively, as their compensation is primarily linked to their performance. Historically, certain former employees engaged in related misconduct and these former employees have been prosecuted. YS Group has taken enhanced internal control measures, including setting up a supervision group, reinforcing internal auditing efforts, and enhancing training and education on a regular basis in respect of anti-corruption laws to its employees. YS Group cannot assure you that these enhanced internal control measures will avoid the occurrence of similar events in the future or that its employees will not violate the anti-bribery laws of China, the United States and other jurisdictions. Such violations could have a material adverse effect on YS Group's reputation, business, prospects and brand. Moreover, YS Group could be liable for actions taken by these employees, including any violation of applicable laws in connection with the marketing or sales of products, such as China's anti-corruption laws and the Foreign Corrupt Practices Act of the United States, or the FCPA. In particular, if employees make any payments that are forbidden under the FCPA, YS Group could be subject to civil and criminal penalties imposed by the U.S. government. In addition, PRC laws regarding what types of payments to promote or sell products are impermissible in the pharmaceutical industry are not always clear. As a result, YS Group, its employees or affiliates could make certain payments in connection with the promotion or sales of YS Group's products or other activities involving YS Group's products which at the time are considered by YS Group to be legal but are later deemed impermissible by the PRC government. Any of the circumstances may materially and adversely affect YS Group's business, results of operations and financial condition.

Failure to comply with anti-bribery laws could disrupt YS Group's business and lead to criminal and civil penalties, including imprisonment, criminal and civil fines, loss of export licenses, and suspension of YS Group's qualification to do business with government authorities and CDCs. Other remedial measures may include further changes or enhancements to YS Group's procedures, policies, and controls and potential personnel changes and/or disciplinary actions, any of which could have a material adverse effect on YS Group's business, financial condition, results of operations and liquidity. YS Group's reputation could be tarnished by any allegation or impropriety that YS Group violated or may have violated such laws.

Product liability claims or lawsuits could cause YS Group to incur substantial liabilities.

YS Group faces an inherent risk of product liability exposure related to the use of its marketed product and the use of its product candidates in clinical trials or any product candidates. YS Group has been and may in the future continue to be involved in product liability claims. Historically, YS Group encountered certain civil and administrative proceedings in respect of its products. If YS Group cannot successfully defend against claims that the use of such product or product candidates, including any of its product candidates that have received regulatory approval, caused injuries, YS Group could incur substantial liabilities. YS Group may be held liable and/or suffer reputation damage even if YS Group is not at fault. Regardless of merit or eventual outcome, liability claims may result in:

- decreased demand for YS Group's marketed product and product candidates;
- product recalls, withdrawals or labeling, marketing or promotional restrictions;
- significant negative media attention and reputational damage;
- withdrawal of clinical trial participants and inability to continue clinical trials;

Table of Contents

- hindered relationships with strategic partners, third party service providers, or regulatory authorities;
- loss of existing or potential collaborations or contracts;
- a negative impact on YS Group’s ability to recruit and retain key personnel;
- increased insurance premiums or inability to obtain insurance coverage;
- significant costs to defend the related litigation;
- substantial monetary awards to trial participants or patients;
- inability to commercialize any product candidates that YS Group may develop;
- initiation of scrutiny investigations by regulators and authorities, leading to more stringent regulatory requirements;
- a diversion of management’s time and YS Group’s resources; and
- a decline in YS Group’s share price.

The Vaccine Administration Law of the PRC (the “VAL”), which was promulgated on June 29, 2019 and came into effect on December 1, 2019, requires YS Group to have compulsory liability insurance to cover vaccine product liability claims. The specific measures for implementing the compulsory liability insurance system for vaccines shall be formulated by the drug administrative department of the State Council in conjunction with the competent health department of the State Council and the insurance regulatory authority. To be implemented, the NMPA published a draft of the Administrative Measures on Vaccines Liability Compulsory Insurance for public comments in October 2020. To date, the draft has not become effective. Once passed, it will function jointly with the VAL to regulate the purchase of vaccines liability compulsory insurance, among others, including the liability limitation and methods for covering insurance. As these laws and regulations are relatively new and evolving, it is uncertain and in flux how the insurance companies and the governmental authorities will implement and carry out them in practice. YS Group cannot assure you it will be fully compliant with these requirements, or that it will be able to enter into insurance agreements on commercially reasonable terms or at all, or that available insurance policies will fully cover YS Group’s potential liabilities arising from its approved vaccines. As of the date of this prospectus, YS Group has maintained compulsory liability insurance for YSJA™ rabies vaccine in China. In addition, YS Group maintains liability insurance for its ongoing clinical trials (which covers the patient human clinical trial liabilities including, among others, bodily injury) in accordance with the relevant local laws and regulations where they are conducted. However, YS Group’s insurance coverage may not fully cover its potential liabilities. Inability to obtain sufficient insurance coverage at an acceptable cost or otherwise to protect against potential product liability claims could prevent or inhibit the commercialization of products YS Group develops, alone or with its collaborators.

YS Group may be restricted from transferring its scientific data abroad and subject to regulations on human genetic resources.

On March 17, 2018, the General Office of the State Council promulgated the Measures for the Management of Scientific Data (the “Scientific Data Measures”), which provides a broad definition of scientific data and relevant rules for the management of scientific data. According to the Scientific Data Measures, enterprises in China must seek governmental approval before any scientific data involving a “state secret” may be transferred abroad or to foreign parties. Further, any researcher conducting research funded at least in part by the Chinese government is required to submit relevant scientific data for management by the entity to which such researcher is affiliated before such data may be published in any foreign academic journal. Although vast majority of the R&D projects have been funded by YS Group since the inception of the company, certain R&D projects were partially benefited from grants provided by Chinese governments. As of the date of this prospectus, YS Group has not provided any scientific data involving “state secret” in the course of foreign communication and cooperation, and therefore YS Group believes that it does not need to obtain relevant permission and approvals pursuant to the Scientific Data Measures. Given the term “state secret” is not clearly defined in the Scientific Data Measures, YS Group cannot assure you that it can always identify if there is any “state secret” in its scientific data and obtain relevant approvals for sending scientific data (such as the results of YS Group’s preclinical studies or clinical trials conducted within China) abroad or to its foreign partners. If YS Group is unable to obtain necessary approvals in a timely manner, or at all, its R&D of product candidates may be hindered,

which could materially adversely affect YS Group's business, financial condition, results of operations and prospects. If the relevant government authorities consider the transmission of YS Group's scientific data to be in violation of the requirements under the Scientific Data Measures, YS Group may be subject to rectification and other administrative penalties imposed by those government authorities.

According to the Regulation on the Management of Human Genetic Resources, as promulgated by the State Council on May 28, 2019, which became effective on July 1, 2019, in case foreign organizations and institutions established or actually controlled by foreign organizations or individuals intend to use PRC human genetic resources to carry out scientific research activities, such activities shall abide by PRC laws and regulations and be carried out in cooperation with scientific research institutions, higher education institutions, medical institutions and enterprises in China. Where clinical institutions, to obtain marketing licenses of relevant drugs and medical devices in China, make use of PRC human genetic resources to carry out international cooperation in clinical trials in clinical institutions not involving the exit of PRC human genetic resource materials, approval is not needed. Instead, the cooperating parties shall, before conducting clinical trials, submit the types, quantities and uses of the human genetic resources involved to the administrative department of science and technology for filing. The Implementation Measures of Administrative Regulations of the PRC on Human Genetic Resources, which further specify the definition of foreign entities, filing of international cooperation and relevant administrative penalties, was promulgated by the Ministry of Science and Technology on May 26, 2023, and came into effect on July 1, 2023. As of the date of this prospectus, YS Group's current clinical trials in China, which involve PRC human genetic resources, are conducted in an international cooperation manner between YS Group and PRC institutions and enterprises, and such cooperation has been approved by or filed with the competent authority. However, as uncertainties exist regarding the interpretation and implementation of these regulations, YS Group cannot assure you it has been and will be fully in compliance with these regulations, including obtaining the filings or approvals in a timely manner or at all. Any failure to be compliant with these regulations may result in various penalties or other regulatory actions being imposed on YS Group, such as confiscation of the revenues that were generated through the unauthorized activities, the imposition of fines, which could have an adverse effect on YS Group's business and results of operations.

YS Group and its CROs are subject to stringent privacy laws, information security policies and contractual obligations related to data privacy and security, and YS Group may be exposed to risks related to its management of the medical data of subjects enrolled in YS Group's clinical trials and other personal or sensitive information.

YS Group's CROs, on behalf of YS Group, routinely receive, collect, generate, store, process, transmit and maintain medical data treatment records and other personal details of subjects enrolled in YS Group's clinical trials, along with other personal or sensitive information. As such, YS Group and its CROs are subject to the relevant data protection and privacy laws, directives, regulations and standards that apply to the collection, use, retention, protection, disclosure, transfer and other processing of personal data in the jurisdictions in which YS Group operates and conduct its clinical trials, as well as contractual obligations. These data protection and privacy law regimes continue to evolve and may result in ever-increasing public scrutiny and escalating levels of enforcement and sanctions and increased costs of compliance. Failure to comply with any of these laws could result in enforcement action against YS Group, including fines, imprisonment of company officials and public censure, claims for damages by customers and other affected individuals, damage to YS Group's reputation and loss of goodwill, any of which could have a material adverse effect on YS Group's business, financial condition, and results of operations or prospects.

Such data protection and privacy laws and regulations generally require clinical trial sponsors and operators and their personnel to protect the privacy of their enrolled subjects and prohibit unauthorized disclosure of personal information. If such institutions or personnel divulge the patients' private or medical records without their consent, they will be held liable for damage caused thereby. While YS Group has taken measures to maintain the confidentiality of the medical records and personal data of patients enrolled in its clinical trials, these measures may not be always effective. YS Group's information technology systems could be breached through hacking activities, and personal information could be leaked due to theft or misuse of personal information arising from misconduct or negligence. In addition, YS Group's clinical trials also involve professionals from third-party institutions. YS Group cannot ensure that such persons will always comply with its confidentiality agreements and data privacy measures. Furthermore, any change in such laws and regulations could affect YS Group's ability to use medical data and subject YS Group to liability for the use of such data for previously permitted purposes. Any failure to protect the confidentiality of patients' medical records and personal data, or any restriction on or liability as a result of, YS Group's use of medical data, could have a material adverse effect on its business, financial condition, reputation and results of operations.

[Table of Contents](#)

Moreover, regulatory authorities in China have implemented and are considering implementing a number of additional legislative and regulatory proposals concerning data protection. For instance, the PRC Cyber Security Law, which became effective in June 2017, created China's first national-level information security classified protection system for "network operators," which may include all entities in China that own, manage provide services or use over the internet or other information networks. Drafts of some department regulations for such protection have been published, including the Data Security Management Measures (Draft for Comments) published in May 2019, which may, upon issuance, require security review before transferring human health-related data out of China. On July 7, 2022, the Cyberspace Administration of China published Outbound Data Transfer Security Assessment Measures, which became effective on September 1, 2022 and outlined the security assessment process for outbound data transfer. In addition, certain industry-specific laws and regulations may affect the collection and transfer of personal data in China, such as the Regulation on the Management of Human Genetic Resources. It is possible that these laws, regulations and guidelines may be interpreted and applied in a manner that is inconsistent with YS Group's practices, which could potentially result in confiscation of YS Group's human genetic resource samples and associated data and subject YS Group to administrative fines, penalties and negative publicity.

YS Group's business operations are subject to the regulatory, economic, environmental, and competitive conditions and changes within the Southeast Asia region.

YS Group intends to expand its business and operations to overseas markets such as Southeast Asian countries, and thus may be governed by the laws, regulations and government policies in relevant Southeast Asia jurisdictions, and its business and future growth is dependent on the political, economic, regulatory and social conditions in these countries. There may also be political and social factors influencing government policy-making that will lead to a major shift towards a higher degree of governmental control over the biopharmaceutical industry in the relevant jurisdictions. Such a shift may reduce YS Group's profitability in the long run and hence have an adverse effect on its financial condition, results of operations and prospects. In particular, potential changes in import/export regulations, issues related to intellectual property protection, and potential barriers to entry in these new markets could impact YS Group's operations. In addition, competition laws and regulations of certain Southeast Asia countries may limit its growth and subject YS Group to antitrust and merger control investigations. YS Group may be subject to financial or other penalties or be prohibited from engaging in certain types of businesses or practices as a result of such investigations. YS Biopharma and its subsidiaries are governed by the laws, regulations and government policies in relevant Southeast Asia jurisdictions, and its business and future growth is dependent on the political, economic, regulatory and social conditions in these countries. Any material changes in the regulatory, economic, environmental or competitive conditions in those countries may also have a material adverse effect on its business, financial condition, results of operations, cash flows and prospects.

If YS Group fails to comply with environmental, health and safety laws and regulations of the PRC, it could become subject to fines or penalties or incur costs that could have a material adverse effect on the success of its business.

YS Group is subject to numerous environmental, health and safety laws and regulations, including those governing laboratory and manufacturing procedures and the handling, use, storage, discharge, treatment and disposal of hazardous materials, sewage and wastes. Its operations primarily occur in China and involve the use of hazardous materials, including chemical materials. Its operations also produce hazardous products and waste. Therefore, YS Group is subject to PRC laws and regulations concerning the discharge of hazardous materials, wastewater, gaseous waste and solid waste during its R&D of products. YS Group has engaged competent third-party contractors for the transfer and disposal of these materials and wastes. However, it may not guarantee you that it, at all times, has complied or would comply fully with relevant regulations. Any violation of these regulations may result in substantial fines, criminal sanctions, revocations of operating permits, shutdown of YS Group's facilities and obligation to take corrective measures.

YS Group cannot assure you of the elimination of the risk of contamination or injury from these materials. In the event of contamination or injury resulting from its use of hazardous materials or its or third parties' disposal of hazardous materials, it could be held liable for any resulting damages, and any liability could exceed its resources.

Although YS Group maintains workers' compensation insurance to cover costs and expenses incurred from on-the-job injuries to its employees and third-party liability insurance for injuries caused by unexpected seepage, pollution or contamination, such insurance may not provide adequate coverage against potential liabilities. Furthermore, the PRC government may take steps towards the adoption of more stringent environmental regulations. Due to the possibility

[Table of Contents](#)

of unanticipated regulatory or other developments, the amount and timing of future environmental expenditures may vary substantially from those currently anticipated. If there is any unanticipated change in the environmental regulations, YS Group may need to incur substantial capital expenditures to install, replace, upgrade or supplement its manufacturing facilities and equipment or make operational changes to limit any adverse impact or potential adverse impact on the environment in order to comply with new environmental protection laws and regulations. If such costs become prohibitively expensive, YS Group may be forced to cease certain aspects of its business operations.

The pharmaceutical industry in China is highly regulated and such regulations are subject to change which may affect approval and commercialization of YS Group's marketed product and product candidates.

The pharmaceutical industry in China is subject to comprehensive government regulation and supervision, encompassing the approval, registration, manufacturing, packaging, licensing and marketing of new drugs and vaccines and their development. In recent years, the regulatory framework in China regarding the pharmaceutical industry has undergone significant changes, and YS Group expects that it will continue to undergo significant changes. Any such changes or amendments may result in increased compliance costs on YS Group's business or cause delays in or prevent the successful development or commercialization of its product and product candidates in China and reduce the current benefits it believes are available to YS Group from development and manufacturing in China. In addition, the interpretation and enforcement of these laws and regulations involve significant uncertainty and the possible introduction of new laws or changes to existing laws pose potential risks. Chinese authorities have become increasingly vigilant in enforcing laws in the pharmaceutical industry and any failure by YS Group or its partners to maintain compliance with applicable laws and regulations or obtain and maintain required licenses, permits and filings may result in the suspension or termination of YS Group's business activities in China. YS Group believes its strategy and approach is aligned with the Chinese government's policies in all material respects, but it cannot ensure that its strategy and approach will continue to be aligned.

Risks Related to Manufacturing and Commercialization

YS Group currently relies on the manufacturing facilities for the marketed product and are still in the process of developing additional facilities at other sites. Any disruption of YS Group's current and new facilities or their failure to meet GMP regulatory compliance or other regulatory requirements may have a material adverse effect on YS Group's business, financial condition and results of operations.

There are multiple manufacturing plants in Shenyang which are currently producing its marketed product and clinical samples. YS Group plans to expand or upgrade productivity based on its current manufacture site in Shenyang and Singapore for manufacturing its marketed product and product candidates in the future. Upon completion of the manufacturing process, YS Group first stores the finished goods of its vaccine products in its Shenyang facilities, which are then shipped to YS Group's regional facilities for temporary transit storage before subsequent delivery. YS Group does not maintain back-up facilities, and depend on current facilities for the continued operation of its business. Natural disasters or other unanticipated catastrophic events, including power interruptions, water shortage, storms, fires, earthquakes, terrorist attacks and wars, as well as changes in governmental planning for the land underlying these facilities, could significantly impair the ability of YS Group to manufacture products and operate business and destroy any inventory located in those facilities. The occurrence of such an event could significantly disrupt YS Group's business and materially reduce its revenues and profitability.

In addition, YS Group is required to comply with applicable GMP and other regulatory requirements, including regulatory standards with respect to manufacturing process or product quality and safety, cold-chain logistics during product delivery, and the corresponding maintenance, recordkeeping and documentation standards. YS Group's manufacturing facilities must be approved by governmental authorities before YS Group may use them to commercially manufacture products and are subject to inspection by regulatory agencies. Moreover, YS Group's marketed product must pass quality inspection prior to being permitted to hit the market for sale. Any changes in or updates to the GMP standards could impose higher or different regulatory requirements on YS Group's manufacturing, such as the manufacturing process, standard, technology, personnel and facilities, and YS Group cannot assure you that it will be able to meet the regulatory changes in a timely manner or at all, which could materially and adversely affect YS Group's business operations, results of operations, reputation and prospects. YS Group is also responsible for maintaining effective cold-chain logistics during the vaccine transportation process to the county-level CDCs. If YS Group fails to comply

[Table of Contents](#)

with applicable regulatory requirements at any stage during the manufacturing and transportation process, such as, regulatory standards with respect to manufacturing and transportation processes or product quality, safety and potency, YS Group may be subject to sanctions which could be severe, including but not limited to:

- monetary penalties;
- product recalls or seizure;
- injunctions;
- refusal of regulatory agencies to review pending manufacturing approval applications or supplements to approval applications;
- total or partial suspension of production;
- confiscation of products;
- withdrawals, revocation or non-renewal of approvals, license or permits previously issued; and
- criminal prosecution.

Any disruptions or delays at YS Group's facilities or their failure to meet GMP regulatory compliance or other regulatory requirements would also impair YS Group's ability to develop and commercialize its product and product candidates, which would adversely affect YS Group's business and results of operations.

Real or perceived incidents of product contamination caused by YS Group's marketed product could materially and adversely affect its reputation, results of operations and financial conditions, and subject YS Group to regulatory actions and contractual liabilities.

Product safety and quality are critical to YS Group's business. For example, YS Group's production was halted for certain months in 2013 to address contamination issues. YS Group cannot assure you it will not encounter similar incidents in the future. YS Group's reputation, results of operations and financial condition could be materially and adversely affected by product contamination and its association with any contamination incidents. In addition, the mere publication of information or speculation asserting that YS Group's marketed product contains or has contained any contaminants, over which YS Group has no control, could damage YS Group's reputation and have a material adverse effect on YS Group, regardless of whether such information or speculation have any factual basis. YS Group may be exposed to a number of harmful consequences due to product contamination, including:

- injury or death of patients;
- severe decrease in the demand for, and sales of, the relevant products;
- recall or withdrawal of the relevant products;
- revocation of regulatory approvals for the relevant products or the relevant production facilities;
- damage to the brand name of YS Group's marketed product and its reputation;
- stricter and more frequent regulatory inspections of YS Group's manufacturing facilities and products;
- inability to participate in the centralized tender process;
- delays or disruptions in YS Group's ability to develop new products or expand into new markets;
- exposure to lawsuits and regulatory investigation relating to the relevant products that result in liabilities, fines or penalties; and
- breach of contract with YS Group's major customers and business partners.

Failure to manage the normal manufacturing capacity properly may materially and adversely affect YS Group's revenues and profitability.

The normal manufacturing capacity is calculated based on the designed capacity of YS Group's manufacturing facilities, after taking into account any reduction in capacity caused by, among other factors, suspension of manufacturing for renewal of GMP certification, if required, maintenance or expansion. The normal manufacturing capacity for a product directly determines the maximum amount of immunological biologics that could be produced in a given period and the volume of finished products that will be available for sale in subsequent periods.

Proper management of the normal manufacturing capacity, and in particular, minimizing the time for renewing GMP certification, if required, and maintaining GMP-compliant conditions and sufficient GMP-compliant back-up capacity in preparation for suspension of manufacturing caused by planned or unexpected events, is critical to maintaining a steady supply of products and a stable growth in YS Group's revenues. In addition, if the normal manufacturing capacity is substantially lower than the designed capacity, idle production costs, a major component of YS Group's cost of sales, may increase significantly.

Given the uncertainties inherent in the biopharmaceutical industry, YS Group has been actively taking measures to improve the management of the normal manufacturing capacity, including building new manufacturing capacity, including building new manufacturing facilities. YS Group's contingency planning also includes measures to mitigate the impact of reduced manufacturing capacity, such as adoption of production process and installation of instruments or equipment which are common and versatile for multiple product uses in the future. However, YS Group cannot assure you that such measures will be successful. The failure of such measures may significantly reduce products available for sale in subsequent periods and/or increase the idle costs, materially and adversely affecting YS Group's revenues and profitability.

If YS Group is unable to conduct effective sales and marketing, its business, financial condition, results of operations and prospects could be adversely affected.

Successful sales and marketing are crucial for YS Group to increase the market penetration and sales of its marketed product and expand its market coverage. If YS Group fails to attract, motivate and retain qualified commercialization team members and maintain an effective system to manage YS Group's commercialization team, or if its commercialization team underperforms, YS Group may experience disruptions to its business, declines in sales volume and less favorable market penetration, and fail to compete effectively. If YS Group is unable to increase or maintain the effectiveness and efficiency of its sales and marketing activities, its sales volumes, geographic coverage and business prospects could also be adversely affected. In addition, YS Group's sales and marketing efforts depend in part on the functions of its external service providers. While YS Group implements systematic measures to manage its external service providers, such engagement may expose YS Group to certain risks, including: (1) failure to collect receivables on a timely basis or effectively; (2) failure to possess, maintain or develop the resources and capabilities required as a service provider; (3) failure to maintain or renew relevant qualifications; (4) engaging in non-compliant conducts, especially in those areas out of YS Group's direct supervision; (5) failure to protect YS Group's proprietary information and intellectual properties despite of the contractual obligation; and (6) failure to report adverse events or side effects, or process potential recalls in a timely manner. Any of these incidents may have an adverse impact on YS Group's business and results of operations.

Failure to establish a complete and effective network of cold-chain logistics providers or otherwise maintain effective and comprehensive cold-chain logistics during transportation of YS Group's vaccine products may cause great risk of damage to YS Group's vaccine products and YS Group's reputation and business would suffer.

Vaccines are sensitive biological products. Some vaccines are sensitive to freezing, some to heat and others to light. Vaccine manufacturers are required to sell directly to county-level CDCs and take charge of quality control during transportation until the products are delivered to the county-level CDCs. Furthermore, the vaccines must be transported through a cold-chain within the temperature range provided by relevant requirements. To ensure YS Group's compliance with relevant laws and regulations and maintain product quality and potency, YS Group's vaccines must be stored in good conditions through cold-chain logistics providers. In order to maintain a reliable vaccine cold chain at manufacture level before delivery to its customers, YS Group is required to, among others, establish a complete and effective network of cold-chain logistics providers to store vaccines and diluents within the approved temperature range at all sites, pack and transport vaccines to and from outreach sites according to recommended procedures, and

[Table of Contents](#)

perform regular oversight and monitor on the delivery process to YS Group's customers, or other safety, efficacy and quality issues. YS Group was involved and may in the future be involved in certain administrative proceedings concerning the temperature conditions during the testing and transportation by third parties for YS Group's marketed product, which might have had affected the testing results and resulted in negative implications for YS Group's product quality and reputation. If YS Group or third parties YS Group cooperated with fail to comply with cold-chain logistics during transportation, such as during the delivery process to customers and the inspection process, YS Group's vaccine products may be exposed to inappropriate temperatures or other improper storage conditions and subject to potency diminishment or even potency loss. In this case, all the vaccine products are subject to quality damage and may need to be destroyed. As a result, YS Group's reputation and business would suffer. YS Group may also be exposed to third-party risks with respect to the cold-chain logistics concerning its entire commercialization process, some of which are beyond YS Group's control.

Counterfeits of YS Group's products and illegal vaccines could negatively affect its sales and its reputation and expose YS Group to liability claims.

Certain vaccines distributed or sold may be manufactured without proper licenses or approvals, or are fraudulently mislabeled with respect to their content or manufacturers. These products are generally referred to as counterfeit vaccine products. The counterfeit vaccine product control and enforcement system, particularly in developing markets might be inadequate to discourage or eliminate the manufacturing and sale of counterfeit vaccine products imitating YS Group's products. Since counterfeit vaccine products in many cases have very similar appearances with the authentic vaccine products but are generally sold at lower prices, counterfeits of YS Group's products can quickly erode YS Group's sales volume of the relevant products. Moreover, counterfeit products may or may not have the same chemical composition as YS Group's products do, which may make them less effective than YS Group's products, entirely ineffective or more likely to cause severe adverse side effects. Despite its best efforts, YS Group may not be able to entirely prevent or address such issues due to limitations in regulation enforcement or tracking technologies. This could expose YS Group to negative publicity, reputational damage, fines and other administrative penalties, and may even result in litigation against YS Group. The existence and prevalence of counterfeit vaccine products, products of inferior quality and other unqualified products in recent years from time to time may reinforce the negative image in general of all pharmaceutical products manufactured in China among consumers, and may harm the reputation of companies like YS Group.

Failure to maintain and predict inventory levels in line with demand for YS Group's marketed product could cause YS Group to lose sales or face excess inventory risks and holding costs, which could have a material adverse effect on YS Group's business, financial condition and results of operations.

YS Group maintains an inventory level based on anticipated product demand and production schedule. However, YS Group cannot guarantee that it will be able to maintain proper inventory levels for marketed product and raw materials. Inventory levels in excess of product demand may result in inventory write-downs, expiration of products and increase in inventory holding costs. Conversely, YS Group may experience inventory shortages if YS Group underestimates demand for its products, which may result in unfilled orders and have a negative impact on its relationship with its customers. To manage its inventory level, YS Group has implemented certain measures. See "Business — Inventory Management." However, YS Group cannot assure you that these measures will be effective and its inventory level will decrease in the future. If YS Group's inventory level increases further in the future, its financial condition and cash flow could be materially and adversely affected.

YS Group's business depends on the use of raw materials, and a decrease in the supply or an increase in the cost of these raw materials could materially and adversely affect its business, financial condition and results of operations.

To manufacture its products, YS Group must obtain sufficient quantities of high-quality raw materials at commercially acceptable prices and in a timely manner. Any disruption in production or inability of YS Group's suppliers to produce and provide adequate quantities to meet its needs could impair YS Group's ability to operate its business on a day-to-day basis and to continue its R&D of YS Group's future product candidates. Moreover, YS Group expects its demand for such materials to increase as YS Group expands its business scale and commercialize its products, and YS Group cannot guarantee that current suppliers have the capacity to meet its demand. YS Group is also exposed to the possibility of increased costs, which YS Group may not be able to pass on to customers and as a result, lower its profitability. In addition, YS Group might need to import certain raw materials from overseas suppliers, which might subject YS Group and its overseas suppliers to compliance cost with respect to import and export regulations and

relevant inspection and quarantine requirements. In addition, although YS Group has implemented quality inspection procedures on such materials before they are used in its manufacturing processes and required its suppliers to maintain high quality standards, YS Group cannot guarantee that it will be able to secure sufficient quantities of raw materials at high quality standards, nor detect all quality issues in the supplies YS Group use. YS Group cannot assure you that these third parties or itself will be able to maintain and renew all filings, licenses, permits and approvals necessary for their operations, supply of raw materials or comply with all applicable laws and regulations. Failure to do so by them may lead to interruption in their business operations, which in turn may result in shortage of the supplies to YS Group. If YS Group is unable to do so and the quality of its products suffer as a result, YS Group may have to delay market supply, clinical trials and regulatory filings, recall its products, be subject to product liability claims, fail to comply with continuing regulatory requirements and incur significant costs to rectify such issue, which may have a material and adverse effect on YS Group's business, financial condition and results of operations.

YS Group deals with potentially harmful biological materials and other hazardous materials that may cause environmental contamination or injury to others.

YS Group's R&D programs, clinical trials and manufacturing operations involve the controlled use of potentially harmful biological materials and other hazardous materials, such as pathogenic microbe. YS Group is required to obtain and timely renew relevant approvals, permits and filings in the course of its development and manufacturing activities while it might face challenges or delays or failures in obtaining or renewing these approvals, permits and filings due to unforeseen circumstances or changes in regulatory environments. In particular, the risk of accidental contamination to the environment or injury to YS Group's employees or others from the use, manufacture, storage, handling or disposal of these materials may not be completely eliminated. In the event of contamination or injury, YS Group could be held liable for any resulting damages, which could exceed its resources or any applicable insurance coverage they may have. Furthermore, governmental agencies could initiate investigations against YS Group, which may result in fines, sanctions, revocations of operating permits, suspension of their operations, closure of YS Group's facilities or other penalties. YS Group's reputation may be harmed as well. Furthermore, laws, rules or regulations regarding handling of harmful biological materials and other hazardous materials, or more stringent environmental regulations that may be adopted in the future, may mandate additional protective and other measures against potential contamination or injury caused by these materials, compliance with which could be costly, and YS Group's profitability could be materially reduced as a result.

Risks Related to YS Group's Financial Position and Working Capital Need

YS Group has incurred significant losses since its inception. YS Group might incur losses or fail to generate sufficient revenue to achieve satisfactory profitability in the future.

YS Group has incurred and expect to continue to incur significant expenses related to clinical trials and preclinical studies in the future. As of the date of this prospectus, YS Group has one marketed product, YSJA™ rabies vaccine, and YS Group has begun to recognize revenue from sales of YSJA™ rabies vaccine since October 2020. YS Group had net loss of RMB191.8 million, RMB106.0 million and RMB145.5 million (\$21.2 million) and RMB174.5 million (\$24.3 million) for the fiscal year ended March 31, 2021, 2022 and 2023 and the six months ended September 30, 2023, respectively. YS Group's future financial position will depend, in part, on the sale of its marketed product, the rate of its future expenditures and its ability to obtain funding through equity or debt financings, strategic collaborations or additional grants. YS Group's future revenue and profitability will also depend upon the size of any markets in which its product and product candidates have received approval, the commercialization of its product candidates, its manufacturing capabilities, its ability to achieve sufficient market acceptance, secure procurement from CDCs in China and other factors.

YS Group expects to continue to incur significant expenses and operating losses in the foreseeable future. YS Group anticipates that its expenses will increase if and as it:

- experiences the sales growth of YSJA™ rabies vaccine;
- continues to advance the clinical trials and preclinical studies of YS Group's current pipelines;
- initiates preclinical, clinical or other studies for new product candidates;

Table of Contents

- manufactures materials for clinical trials and for commercial sale;
- seeks regulatory approvals for YS Group's product candidates that successfully complete clinical trials;
- develops and expands YS Group's commercialization team to promote the sale of its marketed product and commercialize any products for which YS Group may obtain marketing approval;
- acquires or in-licenses other product candidates and technologies;
- maintains, protects and expands YS Group's intellectual property portfolio and compliance system;
- attracts and retains skilled personnel; and
- creates or adopts additional infrastructure to support YS Group's operations as a public company and its product development and planned future commercialization efforts.

YS Group's ability to become and remain profitable depends on its ability to generate sufficient revenue. Even if YS Group is able to generate revenue from the sale of its products, YS Group may not become profitable and may need to obtain additional funding to continue operations. If YS Group fails to become profitable or are unable to sustain profitability on a continuing basis, YS Group may be unable to continue its operations at planned levels and be forced to reduce its operations. YS Group's failure to become and remain profitable would decrease the value of YS Group and could impair its ability to raise capital, expand its business or continue its operations. Failure to become and remain profitable may adversely affect the market price of YS Group's Shares. A decline in the value of YS Group could also cause you to lose all or part of your investment.

YS Group's financial prospects depend on the sale of its marketed product, and the successful development and approval of its clinical-stage and preclinical stage product candidates.

YS Group's ability to generate revenue and become profitable depends upon its ability to achieve sales growth of YSJA™ rabies vaccine and to successfully complete the development of, obtain the necessary regulatory approvals for, and commercialize its product candidates. YS Group expects sales of YSJA™ rabies vaccine to generate substantially all of its revenue in the near term. YS Group's ability to successfully commercialize YSJA™ rabies vaccine and expand its sales will depend on, among other things, YS Group's ability to maintain proper manufacturing facilities, achieve effective sales and marketing, maintain competitive attractiveness, secure widespread acceptance of this product, maintain compliance with ongoing regulatory requirement, properly price and obtain coverage and adequate reimbursement of this product by governmental authorities, private health insurers and other third-party payors. If YSJA™ rabies vaccine fails to achieve successful sales and further sales expansion, it could have a material adverse effect on YS Group's business, financial condition and results of operations.

YS Group is also developing multiple product candidates for infectious diseases and cancer. YS Group has invested a significant portion of its efforts and financial resources in the development of its product candidates, and YS Group expects to continue to incur substantial and increasing expenditures through the projected commercialization of these product candidates. None of these product candidates has been approved for marketing in China or any other jurisdiction and may never receive such approval. YS Group's ability to achieve revenue and profitability is dependent on its ability to expand the sales of YSJA™ rabies vaccine and complete the development of product candidates, obtain necessary regulatory approvals, and have its products manufactured and successfully marketed.

Moreover, because YS Group has limited financial and managerial resources, YS Group focus its product pipelines on R&D programs and product candidates that YS Group identifies for specific indications. As a result, YS Group may forego or delay pursuit of opportunities with other product candidates or for other indications that later prove to have greater commercial potential. YS Group's resource allocation decisions may cause YS Group to fail to capitalize on viable commercial product profitable market opportunities. YS Group's spending on current and future R&D programs and product candidates for specific indications may not yield any commercially viable products. If YS Group does not accurately evaluate the commercial potential or target market for a particular product candidate, YS Group may relinquish valuable rights to that product candidate through collaboration, licensing or other royalty arrangements in cases in which it would have been more advantageous for YS Group to retain sole development and commercialization rights.

YS Group may need to obtain substantial additional financing to fund its operations, and a failure to obtain necessary capital when needed would force YS Group to delay, limit, reduce or terminate its product development or commercialization efforts.

In the three fiscal years ended March 31, 2023 and the six months ended September 30, 2023, YS Group primarily funded its operations through investments from investors, bank borrowings, proceeds from the Business Combination and cash from sales of its marketed rabies vaccines and new product launches for the next five years. YS Group believes it will need to spend substantial resources for the commercialization and sales of its marketed product and the R&D and commercialization of its product candidates. YS Group's future capital requirements depend on many factors, including:

- the commercialization and sale of YS Group's marketed product and the cost and timing of future commercialization activities for its marketed product and its product candidates, if any of YS Group's product candidates are approved for marketing, including product manufacturing, marketing, sales and distribution costs;
- the commercialization and sales of YS Group's product candidates at discovery and clinical stage;
- the progress, results and costs of the clinical, preclinical and other studies of YS Group's product candidates;
- the timing, receipt and amount of sales of, or royalties or milestone payments on, YS Group's future products, if any;
- discovery of new product candidates;
- the timing of, and the costs involved in, obtaining regulatory approvals for YS Group's product candidates;
- the costs involved in preparing, filing, prosecuting patent applications, maintaining, defending and enforcing YS Group's intellectual property rights, including litigation costs and the outcome of such litigation; and
- the extent to which YS Group acquires or in-license other products or technologies.

YS Group plans to use the outstanding cash, together with bank borrowings and cash from operating activities, to primarily fund YS Group's future operations. However, if the commercialization of YS Group's marketed product and product candidates is delayed or terminated, or if expenses increase, YS Group may need additional financing to fund its operations. Additional funds may not be available when YS Group needs them, on terms that are acceptable to YS Group, or at all. YS Group's ability to raise funds will depend on financial, economic and market conditions and other factors, many of which are beyond its control.

YS Group's ability to obtain additional financing from exercise of Warrants may be limited. There is no assurance the holders of the Warrants will elect to exercise any of the Warrants, which could impact YS Group's liquidity position. Whether holders of Warrants will exercise their Warrants, and therefore the amount of cash proceeds YS Group would receive upon exercise, is dependent upon the trading price of the Ordinary Shares. Each Warrant is exercisable for one Ordinary Share at \$11.50. Therefore, if and when the trading price of the Ordinary Shares is less than \$11.50 per share, YS Group expects that holders of Warrants would not have the financial incentive to exercise their Warrants. YS Group could receive up to approximately \$192.6 million if all of the Warrants are exercised for cash, but YS Group would only receive such proceeds if and when the holders of Warrants exercise the Warrants. The Warrants may not be or remain in the money during the period they are exercisable and prior to their expiration and, therefore, it is possible that the Warrants may not be exercised prior to their maturity on March 15, 2028, even if they are in the money, and as such, may expire worthless with minimal proceeds received by YS Group, if any, from the exercise of Warrants. To the extent that any of the Warrants are exercised on a "cashless basis," YS Group will not receive any proceeds upon such exercise. As a result of the above and coupled with the level of Redemption Rate, YS Group does not expect to rely on the cash exercise of Warrants to fund YS Group's operations. Instead, YS Group intends to rely on other sources of cash discussed elsewhere in this registration statement to continue to fund YS Group's operations. See "Management's Discussion and Analysis of Financial Condition and Results of Operations — Liquidity and Capital Resources." If adequate funds are not available to YS Group on a timely basis, YS Group may be required to delay, limit, reduce or terminate preclinical studies, clinical trials or other R&D activities or commercialization for one or more of its product candidates, and in turn will adversely affect YS Group's business prospects.

YS Group had net cash outflow from operating activities in the three fiscal years ended March 31, 2023 and the six months ended September 30, 2023 and may continue to experience such cash outflow for the foreseeable future.

YS Group had net cash used in operating activities of RMB246.6 million, RMB173.5 million, RMB182.5 million (\$26.6 million) and RMB145.8 million and (\$20.3 million) for the fiscal year ended March 31, 2021, 2022 and 2023 and the six months ended September 30, 2023, respectively, and YS Group may not be able to achieve or sustain operating cash inflows for the foreseeable future. Although YS Group believes it has sufficient working capital to fund its operations, if in any case YS Group is unable to maintain adequate liquidity for operating activities, YS Group may not be able to fund its R&D and commercialization activities and to meet its capital expenditure requirements, which may have a material adverse effect on YS Group's business prospects, financial condition and results of operations.

YS Group incurred net liabilities in the past fiscal years, and may continue to have net liabilities in the foreseeable future, which can expose YS Group to liquidity risk.

YS Group had net liabilities (or total deficit) of RMB699.0 million as of March 31, 2022, primarily attributable to the fair value of its convertible redeemable preferred shares and convertible notes which YS Group recognized as liabilities.

While YS Group achieved a positive shift in the financial position with an equity balance of RMB728.5 million (\$106 million) as of March 31, 2023 and RMB557.1 million (\$77.6 million) as of September 30, 2023, the historical presence of net liabilities (total deficit) in prior years can expose YS Group to the risk of shortfalls in liquidity. Such liquidity risk could necessitate seeking financing from external sources such as external debt, which may not be available on terms favorable or commercially reasonable to YS Group or at all. Any difficulty or failure to meet YS Group's liquidity needs as and when needed can have a material adverse effect on its business and prospects.

Historically, YS Group had to allocate significant financial resources to serve its large balance of indebtedness, rather than to fund its operating activities and investments in R&D. This allocation constraint may continue to limit YS Group's R&D capital flexibility and, in turn, adversely affect the development timetable of its product candidates. Moreover, timely interest and principal repayments posed challenges, possibly triggering cross-defaults with other debt, as applicable, as well as limiting YS Group's ability to obtain further debt financing. While the net liabilities position has been improved with the conversion of the convertible redeemable preferred shares upon the consummation of the Business Combination, it is essential to acknowledge that risks stemming from YS Group's historical financial structure remain. Given YS Group's historical reliance on external equity and debt financing, the recurrence of such issues could have a material adverse effect on its business, financial condition and results of operations. The possibility of incurring net liabilities in the future still exists, and should that happen, YS Group's liquidity and its ability to raise funds, obtain bank loans, meet debt obligations and pay debts when they become due and declare and pay dividends will be materially and adversely affected.

If YS Group determines its intangible assets to be impaired, YS Group's results of operations and financial condition may be adversely affected.

As of March 31, 2022 and 2023 and September 30, 2023, YS Group had intangible assets of RMB80.7 million, RMB78.1 million (\$11.4 million) and RMB74.6 million (\$10.4 million), respectively, which primarily consisted of patents relating to YS Group's PIKA adjuvant technology and other licenses, certificates and intellectual properties relating to YS Group's business operations. YS Group's determination on whether intangible assets are impaired requires an estimation of the recoverable amount of the intangible assets, which is based on a number of assumptions made by YS Group's management. If any of these assumptions does not materialize, or if the performance of YS Group's business is not consistent with such assumptions, the carrying amount of the intangible assets may exceed its recoverable amount, and YS Group's intangible assets may be impaired. As a result, YS Group may be required to significantly write off its intangible assets and record a significant impairment loss, which would have a material adverse effect on YS Group's business, results of operations and financial condition.

YS Group is subject to credit risks arising from some customers. If YS Group experiences delays in collecting or if YS Group is unable to collect trade receivables from customers, its results of operations and financial condition could be adversely affected.

YS Group commenced the sale of YSJA™ rabies vaccine in October 2020. In line with market practice, YS Group typically grants its customers a credit period of four months. As of March 31, 2022 and 2023 and September 30, 2023, YS Group had trade receivables, net of RMB308.6 million and RMB463.1 million (\$67.4 million) and RMB429.4 million (\$59.8 million), respectively. As of September 30, 2023, YS Group's trade receivables primarily represented amounts due from county-level CDCs attributable to the sales of YSJA™ rabies vaccines. As a result, YS Group may be exposed to credit risks. YS Group recorded allowance for impairment of trade receivables of RMB13.6 million and RMB24.4 million (\$3.5 million) and RMB29.7 million (\$4.1 million) as of March 31, 2022 and 2023 and September 30, 2023, respectively.

YS Group cannot assure you that its customers could settle trade receivables in a timely manner, or at all, or that YS Group can properly assess and respond in a timely manner to changes in their credit profile. If YS Group's customers' cash flows, working capital, financial condition or results of operations deteriorate, they may be unable, or they may otherwise be unwilling, to pay trade receivables owed to YS Group promptly or at all. YS Group may also be involved in litigations and disputes with its customers related to such credit risks. Any substantial defaults or delays could materially and adversely affect YS Group's cash flows, and YS Group could be required to terminate its relationships with its customers in a manner that may adversely affect YS Group's business, results of operations and financial condition.

YS Group has incurred and may continue to incur substantial share-based payment expenses, which may have a material and adverse effect on YS Group's results of operations and financial condition.

YS Group adopted the 2020 Share Incentive Plan and granted certain awards to its directors, employees and consultants. YS Group believes the grant of share-based compensation is important to its ability to attract, retain and motivate its management team and qualified employees. Upon consummation of the Business Combination, YS Biopharma has assumed such share incentive plan and the outstanding awards granted by YS Group then. As of the date of this prospectus, there are 6,656,582 shares of YS Biopharma reserved for its share incentive plans.

YS Group recorded share-based payment expenses of RMB76.8 million, RMB7.8 million, RMB3.5 million (\$0.5 million) and nil for the fiscal year ended March 31, 2021, 2022 and 2023 and the six months ended September 30, 2023, respectively. YS Group expects to further incur share-based payment expenses in the future as a result of any further grant, which will also dilute existing shareholders' shareholding.

Restrictions imposed by YS Group's outstanding indebtedness and any future indebtedness may limit YS Group's ability to operate its business and to finance its future operations or capital needs.

In March 2022, YS Group completed a \$40 million royalty-based 4.5-year long-term debt transaction with R-Bridge Investment Holdings Pte. Ltd. The terms of the loan facility limit YS Group's ability to, among other things, incur additional indebtedness, incur liens on YS Group's assets, engage in consolidations, mergers, liquidations, dissolutions, sell or otherwise dispose of YS Group's assets, acquire other businesses, make loans, capital contributions, or other investments, or enter into any other transactions outside of the ordinary course of business. In addition, YS Group is obliged to pay shall pay royalties based upon YS Group's annual Net Sales (as defined in the royalty deed dated March 16, 2022 entered into between HK Yisheng and R-Bridge Healthcare Fund, LP) by multiplying the applicable royalty rate by the corresponding amount incremental Net Sales for that financial year. The terms of YS Group's loan facilities and royalty obligations restrict YS Group's current and future operations and could adversely affect YS Group's ability to finance its future operations or capital needs or take advantage of financing opportunities, mergers, acquisitions, investments, and other corporate opportunities that may be beneficial to YS Group's business. In addition, complying with these covenants may make it more difficult for YS Group to successfully execute its business strategy and compete against companies which are not subject to such restrictions.

Risks Related to YS Group's Intellectual Property

The issuance, scope, validity, enforceability and commercial value of YS Group's patent rights are uncertain, and there can be no assurance that any of YS Group's technology, marketed product or product candidates will be protectable or remain protected by valid and enforceable patents. If YS Group is unable to obtain and maintain patent protection for its marketed product and product candidates, or if the scope of such patent protection obtained is not sufficiently broad, third parties may compete directly against YS Group.

YS Group's success depends, in part, on its ability to protect its marketed product and product candidates from competition by obtaining, maintaining and enforcing its intellectual property rights, including patent rights. YS Group seeks to protect its marketed product and product candidates and technology that YS Group considers commercially important by filing PRC and international patent applications. YS Group does not currently own a valid composition of matter patent for its marketed product, YSJA™ rabies vaccine, and rely on YS Group's know-how, proprietary techniques and patents in relation to its manufacturing process, together with established safety and efficacy profile as well as reputation, to protect its marketed product. If YS Group is unable to obtain or maintain patent or other statutory protection with respect to any of its marketed product and product candidates and the technology YS Group develops, or if the scope of such patent or other statutory protection obtained is not sufficiently broad, third parties may compete directly against YS Group, and YS Group's business, financial condition, results of operations, and prospects could be materially and adversely affected.

The patent prosecution process is expensive, time-consuming and complex, and YS Group may not be able to file, prosecute, maintain or license all necessary or desirable patent applications at a reasonable cost or in a timely manner. YS Group cannot assure you that its patent applications will result in the issuance of any patents that effectively protect its product candidates. The scope of a patent application can be significantly reduced before the patent is issued, and it can be reinterpreted after issuance. The scope of protection for issued patents may also vary across different jurisdictions. Changes in either the patent laws or interpretation of the patent laws in various jurisdictions may diminish the value of YS Group's patents or narrow the scope of its patent protection. Patent may not be issued in a form that will provide YS Group with any meaningful protection, prevent competitors or other third parties from competing with YS Group, or otherwise provide YS Group with any competitive advantage. In addition, the patent position of biotechnology and pharmaceutical companies generally is highly uncertain, involves complex legal and factual questions, and has been the subject of considerable litigation in recent years. Third parties may dispute that YS Group's product candidates are not validly protected by the underlying patents relating to PIKA adjuvant due to the uncertainties as to the interpretation of the scope and other parameters relating to such patents, and as such, they may attempt to manufacture and commercialize products similar to YS Group's product candidates without infringing upon any valid patents YS Group holds in the relevant jurisdictions. YS Group cannot assure you it will successfully defend the merits and scope of its patent protection and YS Group may be forced to tolerate and compete with such similar products. Consequently, the issuance, scope, validity, enforceability and commercial value of YS Group's patent rights are highly uncertain, and YS Group cannot assure you that any of its technology, marketed product or product candidates will be protectable or remain protected by valid and enforceable patents.

The issuance of a patent is not conclusive as to its inventorship, scope, validity or enforceability, and YS Group's patents may be challenged in the courts or patent offices in China, Singapore, the United States and other countries or jurisdictions. An adverse determination in any such submission, proceeding or litigation could reduce the scope of, or invalidate, YS Group's owned patent rights, allow third parties to commercialize its technology, marketed product or product candidates and compete directly with YS Group without payment to YS Group. Such proceedings also may result in substantial costs and require significant time from YS Group's scientists and management. YS Group's competitors or other third parties may be able to circumvent YS Group's owned patents by developing similar or alternative technologies or products in a non-infringing manner. Furthermore, the terms of patents are finite. See “— If YS Group does not obtain patent term extension and data exclusivity for any of its product candidates it may develop, YS Group's business may be materially harmed.”

As a result, the patents and patent applications owned by YS Group may not provide it with adequate protection to prevent others from commercializing products similar or identical to those developed by YS Group. Moreover, some of YS Group's patents and patent applications may in the future be co-owned with third parties. If YS Group is unable to obtain an exclusive license to any such third-party co-owners' interest in such patents or patent applications, such co-owners may be able to license their rights to other third parties, including YS Group's competitors, and YS Group's competitors could market competing products and technology. In addition, YS Group may need the cooperation of any

such co-owners of its patents in order to enforce such patents against third parties, and such cooperation may not be provided to YS Group. Any of the foregoing could have a material adverse effect on YS Group's competitive position, business, financial condition, results of operations and prospects.

Obtaining and maintaining YS Group's patent protection depend on compliance with various procedures, document submission, fee payment, and other requirements imposed by governmental patent agencies, and YS Group's patent protection could be reduced or eliminated for noncompliance with these requirements.

Many government patent agencies require compliance with several procedural, documentary, fee payment, and other similar provisions during the patent application and transfer process. YS Group is also dependent on its agents to take the necessary action to comply with these requirements. YS Group cannot assure you that it or its agents will comply with these requirements in a timely manner. YS Group did not experience any material failure to comply with these requirements in the three fiscal years ended March 31, 2023 and the six months ended September 30, 2023 that resulted in any material adverse effect on the scope or validity of YS Group's owned patents. If YS Group fails to comply with these requirements, it may be subject to additional late payment fines or injunctions. There are situations, however, in which non-compliance can result in abandonment or lapse of the patent or patent application, resulting in a partial or complete loss of patent rights in the relevant jurisdiction. In such an event, potential competitors might be able to enter the market with similar or identical products or technology, which could have a material adverse effect on YS Group's business, financial condition, results of operations, and prospects.

If YS Group does not obtain patent term extension and data exclusivity for any of its product candidates it may develop, YS Group's business may be materially harmed.

The Patent Law of China, amended in October 2020 and effective on June 1, 2021, provides that, upon the requests of the patentee, the patent administrative authorities shall grant a limited patent term extension to the patent relating to a new drug that was approved in China, as compensation for patent term lost during the NMPA regulatory review process of such new drug. The compensation period shall not exceed five years, and the total validity period of patent rights for such approved new drug shall not exceed 14 years after the market approval of such drug. During the regulatory review process of a new drug, should any disputes arise due to the patent relating to the new drug, for which approval is being sought, whether the patent will be infringed by the proposed drug may be answered by a people's court upon the requests of the relevant parties before the final approval is provided. The NMPA may decide whether to suspend the approval review process of the proposed drug based on the judgment of the people's court. On July 4, 2021, the NMPA and the China National Intellectual Property Administration issued Implementing Measures for the Early Settlement Mechanism for Drug Patent Disputes (for Trial Implementation). On the same day, the Supreme People's Court of the PRC issued Provisions of Supreme People's Court on Several Issues Concerning the Application of Law in the Hearing of Civil Cases Involving Disputes over Patent Rights Relating to Drugs under Application for Registration, which became effective on July 5, 2021. However, relevant regulations are implemented for a relatively short period of time and therefore the enforcement of laws and regulations regarding the patent linkage system remain uncertain in China. In addition, Chinese regulators set forth a framework for integrating data exclusivity into the Chinese regulatory regime, but no specific regulations were issued. These factors result in weaker protection for YS Group against generic competition in China than could be available to YS Group in the United States. If YS Group is unable to obtain patent term extension or term of any such extension is less than it requests, YS Group's competitors may obtain approval of competing products following YS Group's patent expiration, and YS Group's business, financial condition, results of operations, and prospects could be materially harmed.

Developments in patent law could have a negative impact on YS Group's business.

Changes in either the patent laws or interpretation of the patent laws in China, the United States and other government authorities could increase the uncertainties and costs surrounding the prosecution of patent applications and the enforcement or defense of issued patents. Such changes could potentially diminish the value of YS Group's patents or narrow the scope of its patent protection. Court rulings could also impact how patents are interpreted and enforced. For example, Leahy-Smith America Invents Act (the "America Invents Act"), which was signed into law in September 2011, includes a number of significant changes to U.S. patent law. These changes include a transition from a "first-to-invent" system to a "first inventor-to-file" system as of March 2013, changes to the way issued patents are challenged, and changes to the way patent applications are disputed during the examination process. These include allowing third party submission of prior art to the United States Patent and Trademark Office (the "USPTO") during patent prosecution and additional procedures to attack the validity of a patent by the USPTO administered post grant proceedings, including

post grant review, inter parties review, and derivation proceedings. The PRC laws on the protection of intellectual property rights of drugs are also evolving. The Patent Law of the PRC and the Implementation Rules of the Patent Law of the PRC are applicable to drugs protected by patents. On October 17, 2020, the Standing Committee of the National People's Congress of the PRC passed the decision to amend the Patent Law of the PRC. The amended patent law came into effect on June 1, 2021. The amended Patent Law provides, among other things, that (1) in case an invention patent is only granted after four years or more from its filing date and three years or more after a request for substantive examination was filed, the patentee can request for an extension of patent term for any unreasonable delay; and (2) the patent term extension will also be available for pharmaceutical-related patents, similar to a supplementary protection certificate in other jurisdictions, to compensate the time spent in obtaining marketing authorization for a drug. The maximum extension for drug-related patents shall be five years with a total effective patent term not exceeding 14 years after the marketing authorization of such drug is obtained. However, it is not entirely clear what procedures must be followed in order to apply for such extension.

Changes to patent law may affect YS Group's ability to obtain patents, and if obtained, to enforce or defend them. Accordingly, it is not entirely clear what, if any, impact the changes to patent law will have on the cost of prosecuting YS Group's patent applications and its ability to obtain patents based on its discoveries and to enforce or defend any patents that may issue from its patent applications, all of which could have a material adverse effect on YS Group's business, financial condition, results of operations and prospects.

If YS Group is unable to maintain the confidentiality of YS Group's trade secrets, its business and competitive position may be harmed.

In addition to the protection afforded by issued patents and pending patent applications, YS Group relies upon unpatented trade secret protection, unpatented know-how and continuing technological innovation to develop and maintain YS Group's competitive position. However, trade secrets and know-how can be difficult to protect. YS Group also seeks to protect its proprietary technology and processes, in part, by entering into confidentiality agreements with parties that have access to them, such as its partners, collaborators, scientific advisors, employees, consultants and other third parties, and invention assignment agreements with its consultants and employees. YS Group cannot guarantee that it has entered into such agreements with each party that may have or have had access to its trade secrets or proprietary technology and processes. YS Group may not be able to prevent the unauthorized disclosure or use of its technical know-how or other trade secrets by the parties to these agreements, however, despite the existence of confidentiality agreements and other contractual restrictions. If any of the partners, collaborators, scientific advisors, employees and consultants who are parties to these agreements breaches or violates the terms of any of these agreements or otherwise discloses YS Group's proprietary information, YS Group may not have adequate remedies for any such breach or violation, and YS Group could lose its trade secrets as a result. If a third party illegally disclosed or misappropriated YS Group's trade secrets, it could be difficult, expensive and time-consuming to enforce a claim, including through intellectual property litigations or other proceedings, and the outcome is unpredictable. In addition, courts in China and other jurisdictions inside and outside the United States may be less prepared, less willing or unwilling to protect trade secrets. YS Group's trade secrets could otherwise become known or be independently discovered by its competitors or other third parties.

For example, competitors could purchase YS Group's marketed product and product candidates, attempt to replicate some or all of the competitive advantages YS Group derives from its development efforts, and design around YS Group's intellectual property protecting such technology or develop their own competitive technologies that fall outside of YS Group's intellectual property rights. If any of YS Group's trade secrets were to be disclosed or independently developed by a competitor, YS Group would have no right to prevent them, or others to whom they communicate it, from using that technology or information to compete against YS Group, which may have a material adverse effect on YS Group's business, prospects, financial condition and results of operations.

YS Group may be subject to claims challenging the inventorship of its patents and ownership of other intellectual property.

Although YS Group is not currently experiencing any claims challenging the inventorship of its patents or ownership of its other intellectual property, YS Group may be subject to claims that former employees, collaborators or other third parties have an interest in YS Group's patents or other intellectual property as inventors or co-inventors. Litigation may be necessary to defend against these and other claims challenging inventorship. If YS Group fails to defend any such claims, in addition to paying monetary damages, it may lose rights such as exclusive ownership of, or right to

[Table of Contents](#)

use, YS Group's patent rights or other intellectual property. Such an outcome could have a material adverse effect on YS Group's business. Even if YS Group is successful in defending against such claims, litigation could result in substantial costs and be a distraction to management and other employees.

YS Group may be subject to claims that it or its employees, consultants or advisors have wrongfully used or disclosed alleged trade secrets of competitors or their current or former employers or are in breach of non-competition or non-solicitation agreements with competitors or other third parties.

YS Group could in the future be subject to claims that it or its employees, consultants or advisors have inadvertently or otherwise used or disclosed alleged trade secrets or other proprietary information of current or former employers, competitors or other third parties. Many of YS Group's employees, consultants and advisors are currently or were previously employed at universities or other biotechnology or pharmaceutical companies, including YS Group's competitors or potential competitors. Although YS Group tries to ensure that its employees and consultants do not improperly use the intellectual property, proprietary information, know-how or trade secrets of others in their work for YS Group, YS Group may be subject to claims that YS Group or these individuals have breached the terms of his or her non-competition or non-solicitation agreement, or that YS Group or these individuals have, inadvertently or otherwise, used or disclosed the alleged trade secrets or other proprietary information of a current or former employer, competitor or other third parties.

Litigation may be necessary to defend against the abovedescribed claims. Even if YS Group is successful in defending against these claims, litigation could result in substantial costs and could be a distraction to management and research personnel. If YS Group's defenses to these claims fail, in addition to requiring YS Group to pay monetary damages, a court could prohibit YS Group from using technologies or features that are essential to its product candidates, if such technologies or features are found to incorporate or be derived from the trade secrets or other proprietary information of the former employers or competitors. An inability to incorporate such technologies or features would have a material adverse effect on YS Group's business and may prevent YS Group from successfully commercializing its product candidates. In addition, YS Group may lose valuable intellectual property rights or personnel as a result of such claims. Moreover, any such litigation or threat of such litigation may adversely affect YS Group's ability to hire employees or contract with independent sales representatives. A loss of key personnel or their work product could hamper or prevent YS Group's ability to commercialize its product and product candidates, which would have a material adverse effect on its business, results of operations and financial condition.

In addition, while it is YS Group's policy to require its employees and contractors who may be involved in the conception or development of intellectual property to execute agreements assigning such intellectual property to YS Group, YS Group may be unsuccessful in executing such an agreement with each party who, in fact, conceives or develops intellectual property that YS Group regards as its own. The assignment of intellectual property rights may not be self-executing, or the assignment agreements may be breached, and YS Group may be forced to bring claims against third parties, or defend claims that they may bring against YS Group, to determine the ownership of what YS Group regards as its intellectual property. Such claims could have a material adverse effect on YS Group's business, financial condition, results of operations and prospects.

YS Group may not be able to protect and effectively enforce its intellectual property rights including patents.

YS Group may not be able to identify the infringement of its intellectual property rights including patents at an early stage and may forfeit the best opportunity to enforce the protection of such intellectual property rights. Even if YS Group is able to enforce intellectual property rights in a timely manner, the legal system in certain jurisdictions including China may have generally provided less protection for intellectual property rights than certain other legal systems, such as in the United States. Policing unauthorized use of proprietary technology is difficult and expensive, and YS Group might need to resort to litigation to enforce or defend patents issued to them or to determine the enforceability, scope and validity of its proprietary rights or those of others. The experience and capabilities of courts in different and other jurisdictions in handling intellectual property litigation varies, and outcomes are unpredictable. This variation and unpredictability could make it more difficult for YS Group to prevent competitors from using its patented technology in certain countries. Furthermore, such litigation may be time-consuming, require significant expenditures of cash, resources and management efforts and could harm YS Group's business, financial condition and results of operations. As a result, YS Group may not be able to enforce its intellectual property right and effectively stop infringe, and an adverse determination in any such litigation could materially impair its intellectual property

[Table of Contents](#)

rights and may harm its business, prospects and reputation. Furthermore, technological advances could potentially make YS Group's patents obsolete, reducing their protective value and possibly rendering YS Group's products less competitive.

YS Group may not be able to protect its intellectual property rights throughout the world.

YS Group owns, or have filed application for, patents for its product candidates in over 30 countries and regions. Filing, prosecuting, maintaining and defending patents on YS Group's product candidates in all countries and regions throughout the world could be prohibitively expensive for YS Group. Competitors may use YS Group's technologies in jurisdictions where YS Group has not obtained patent protection to develop their own product candidates and may also export otherwise infringing products to jurisdictions where YS Group has patent protection, but where enforcement rights are not strong. These products may compete with YS Group's marketed product and product candidates and YS Group's patent rights or other intellectual property rights may not be effective or adequate to prevent them from competing.

The legal systems of some countries do not favor the enforcement of patents, trade secrets and other intellectual property, particularly those relating to biopharmaceutical products, which could make it difficult in those jurisdictions for YS Group to stop the infringement or misappropriation of its patents or other intellectual property rights, or the marketing of competing products in violation of its proprietary rights. Proceedings to enforce YS Group's intellectual property and proprietary rights in foreign jurisdictions could result in substantial costs and divert YS Group's efforts and attention from other aspects of its business, could put YS Group's patents at risk of being invalidated or interpreted narrowly, could put YS Group's patent applications at risk of not issuing, and could provoke third parties to assert claims against YS Group. YS Group may not prevail in any lawsuits that YS Group initiates, and the damages or other remedies awarded, if any, may not be commercially meaningful. Accordingly, YS Group's efforts to enforce its intellectual property and proprietary rights around the world may be inadequate to obtain a significant commercial advantage from the intellectual property that YS Group develops or licenses.

Furthermore, many countries have compulsory licensing laws under which a patent owner may be compelled to grant licenses to third parties. In addition, many countries limit the enforceability of patents against government agencies or government contractors. In these countries, the patent owner may have limited remedies, which could materially diminish the value of such patent. If YS Group is forced to grant a license to third parties with respect to any patents relevant to its business, its competitive position may be impaired, and its business, financial condition, results of operations and prospects may be adversely affected.

YS Group may become involved in lawsuits to protect or enforce its intellectual property, which could be expensive, time-consuming and unsuccessful. YS Group's patent rights relating to its product candidates could be found invalid or unenforceable if challenged in court or before other authorities.

Competitors may infringe YS Group's patent rights or misappropriate or otherwise violate YS Group's intellectual property rights. To counter infringement or unauthorized use, litigation may be necessary in the future to enforce or defend YS Group's intellectual property rights, to protect YS Group's trade secrets or to determine the validity and scope of YS Group's own intellectual property rights or the proprietary rights of others. Such litigations can be expensive and time-consuming, with results varying significantly across different jurisdictions. Any claims that YS Group asserts against perceived infringers could also provoke these parties to assert counterclaims against YS Group alleging that YS Group infringes their intellectual property rights. Many of YS Group's current and potential competitors have the ability to dedicate substantially greater resources to enforce and/or defend their intellectual property rights than YS Group can. YS Group cannot assure you it will be able to prevent third parties from infringing upon or misappropriating its intellectual property in the future. Litigation could result in substantial costs and diversion of management resources, which could harm YS Group's business operations and financial results.

In addition, in an infringement proceeding, a court may refuse to stop the other party from using the technology at issue on the grounds that YS Group's owned patents do not cover such third-party technology. An adverse result in any litigation proceeding could put YS Group's patent, as well as any patents that may issue in the future from YS Group's pending patent applications, at risk of being invalidated, held unenforceable or interpreted narrowly. Furthermore, because of the substantial amount of discovery required in connection with intellectual property litigation, there is a risk that some of YS Group's confidential information could be compromised by disclosure during this type of litigation. Moreover, such third parties could counterclaim that YS Group infringes, misappropriates or otherwise

[Table of Contents](#)

violate their intellectual property or that a patent YS Group has asserted against them is invalid or unenforceable. In patent litigation, defendant counterclaims challenging the validity, enforceability or scope of asserted patents are commonplace and there are numerous grounds upon which a third party can assert invalidity or unenforceability of a patent.

Furthermore, third parties may initiate legal proceedings before administrative bodies in China and/or other jurisdictions, even outside the context of litigation, against YS Group with respect to its owned intellectual property to assert challenges to such intellectual property rights. Such mechanisms include re-examination, inter parties review, post-grant review, interference proceedings, derivation proceedings and equivalent proceedings in foreign jurisdictions (e.g., opposition proceedings). Such proceedings could result in revocation, cancellation or amendment to YS Group's patents in such a way that they no longer cover and protect its product candidates. YS Group is not involved in any pending proceeding where a third party attempted to challenge the validity, enforceability or scope of its intellectual property rights as of the date of this prospectus. YS Group cannot assure you that it will always prevail in any such proceeding as its outcome is generally unpredictable. The cost to YS Group of any patent litigation or similar proceeding could be substantial, and it may consume significant management and other personnel time. YS Group does not maintain insurance to cover intellectual property infringement, misappropriation or violation.

An adverse result in any litigation or other intellectual property proceeding could put one or more of YS Group's patents at risk of being invalidated, rendered unenforceable or interpreted narrowly. If a defendant were to prevail on a legal assertion of invalidity or unenforceability of YS Group's patents covering one or more of its product candidates, YS Group would lose at least part, and perhaps all, of the patent protection covering such product candidates. Competing products may also be sold in other countries in which YS Group's patent coverage might not exist or be as strong. If YS Group loses a foreign patent lawsuit, alleging its infringement of a competitor's patents, YS Group could be prevented from marketing its products in one or more foreign countries. Furthermore, because of the substantial amount of discovery required in connection with intellectual property litigation, there is a risk that some of YS Group's confidential information could be compromised by disclosure during this type of litigation.

Any of these outcomes would have a materially adverse effect on YS Group's business, financial condition, results of operations and prospects.

Intellectual property litigation and proceedings could cause YS Group to spend substantial resources and distract YS Group's personnel from its normal responsibilities.

Third parties who bring successful claims against YS Group for infringement of their intellectual property rights may obtain injunctive or other equitable relief, which could prevent YS Group from developing and commercializing one or more of its marketed product and product candidates. Defense of these claims, regardless of their merits, would involve substantial litigation expense and would be a substantial diversion of employee resources from YS Group's business. In the event of a successful claim of infringement or misappropriation against YS Group, YS Group may have to pay substantial damages, including treble damages and attorneys' fees in the case of willful infringement, obtain one or more licenses from third parties, pay royalties or redesign its infringing marketed product and product candidates, which may be impossible or require substantial time and monetary expenditure. In the event of an adverse result in any such litigation, or even in the absence of litigation, YS Group may need to obtain licenses from third parties to advance its research or allow commercialization of its marketed product and product candidates. YS Group cannot predict whether any required license would be available at all or whether it would be available on commercially reasonable terms, and YS Group may fail to obtain any of these licenses on commercially reasonable terms, if at all. In the event YS Group is unable to obtain such a license, YS Group would be unable to further develop and commercialize one or more of its marketed product and product candidates, which could harm YS Group's business significantly. YS Group may also elect to enter into license agreements in order to settle patent infringement claims or to resolve disputes prior to litigation, and any such license agreements may require YS Group to pay royalties and other fees that could significantly harm YS Group's business.

Even if resolved in YS Group's favor, litigation or other legal proceedings relating to YS Group's other third parties' intellectual property claims may cause YS Group to incur significant expenses and could distract YS Group's personnel from its normal responsibilities. In addition, there could be public announcements of the results of hearings, motions, or other interim proceedings or developments, and if securities analysts or investors perceive these results to be negative, it could have a substantial adverse effect on the price of YS Group's common stock. Such litigation or proceedings could substantially increase YS Group's operating losses and reduce the resources available for development activities

[Table of Contents](#)

or any future sales and marketing activities. YS Group may not have sufficient financial or other resources to conduct such litigation or proceedings adequately. Some of YS Group's competitors may be able to sustain the costs of such litigation or proceedings more effectively than YS Group can because of their greater financial resources and more mature and developed intellectual property portfolios.

Uncertainties resulting from the initiation and continuation of patent litigation or other proceedings could have a material adverse effect on YS Group's ability to compete in the marketplace.

The success of YS Group's business may depend on licensing, collaboration and other strategic arrangements with third parties, and YS Group cannot assure you that its licensing, collaboration or other strategic efforts will succeed or that YS Group will derive any benefits from these arrangements.

YS Group has entered into collaboration agreements with third parties from time to time to jointly develop vaccines and other biologics. See "Business — YS Group's Strategic Collaborations" for details. The success of YS Group's business strategy depends, in part, on its ability to enter into licensing, collaboration and other strategic arrangements and to manage effectively the resulting relationships. YS Group cannot assure you that the organizations or institutes it collaborates with will not terminate such cooperation's or enter into collaborative relationships with its competitors in the future.

YS Group's ability to enter into agreements with commercial partners depends in part on its ability to convince them of the value of YS Group's technology, expertise, know-how or distribution channel. This may require substantial time and effort on YS Group's part. While YS Group anticipates expending substantial funds and management efforts, YS Group cannot assure you that collaborative relationships will result or that YS Group will be able to negotiate additional collaborative agreements in the future on acceptable terms, if at all. Furthermore, YS Group may incur significant financial commitments to partners in connection with potential licenses, collaboration or other agreements. In addition, YS Group may not be able to control the areas of responsibility undertaken by its commercial partners and its business may suffer greatly should these partners prove unable to carry a product candidate forward to full commercialization, lose interest in dedicating the necessary resources toward developing any such product quickly, fail to implement the appropriate quality control measures in their manufacture of the products licensed to them by YS Group or decline to expend the necessary effort or resources to market and sell such products.

Moreover, third parties may terminate YS Group's licensing, collaboration and other strategic arrangements if YS Group does not perform as required under these arrangements. In addition, these third parties may also breach or terminate their agreements with YS Group or otherwise fail to conduct their activities in connection with its relationships in a timely manner. If YS Group or its partners terminate or breach any of YS Group's licenses or relationships, YS Group may:

- lose the rights to manufacture, market or sell certain products;
- experience significant delays in the development or commercialization of product candidates;
- not be able to obtain any other licenses on acceptable terms, if at all;
- need to allocate resources for damage control and remediation which would otherwise have been used for commercialization and business activities;
- initiate legal proceedings against YS Group's former partners or have such proceedings initiated against it and
- incur liability for damages.

Licensing arrangements and collaborative relationships in YS Group's industry can be very complex, particularly with respect to intellectual property rights. Disputes may arise in the future regarding ownership rights to technology developed by or with other parties. These and other possible disagreements between YS Group and third parties with respect to YS Group's licenses or their collaborative relationships could lead to delays in the research, development, manufacture and commercialization of current product or product candidates. These disputes could also result in litigation or arbitration, both of which are time-consuming and expensive. These third parties also may pursue alternative technologies or product candidates either on their own or in collaborative relationships with others in direct competition with YS Group.

Intellectual property rights do not necessarily address all potential threats.

The degree of future protection afforded by YS Group's intellectual property rights is uncertain because intellectual property rights have limitations and may not adequately protect its business or permit YS Group to maintain its competitive advantage. For example:

- others may be able to make vaccines and other biologics that are similar to any marketed product or product candidates YS Group may develop or utilize similar technology but that are not covered by the claims of the patents that YS Group may own or in-license in the future;
- YS Group, patent owners of patent rights that YS Group may in-license, or current or future collaborators might not have been the first to make the inventions covered by the issued patent or pending patent application that YS Group licenses or may own in the future;
- YS Group, patent owners of patent rights that YS Group may in-license, or current or future collaborators might not have been the first to file patent applications covering certain of YS Group's or their inventions;
- others may independently develop similar or alternative technologies or duplicate any of YS Group's technologies without infringing, misappropriating or otherwise violating YS Group's owned or licensed intellectual property rights;
- it is possible that YS Group's pending patent applications or those that YS Group may own in the future will not lead to issued patents;
- issued patents that YS Group holds rights to may be held invalid or unenforceable, including as a result of legal challenges by its competitors;
- YS Group's competitors might conduct R&D activities in countries where YS Group does not have patent rights and then use the information learned from such activities to develop competitive products for sale in YS Group's major commercial markets;
- YS Group may not develop additional proprietary technologies that are patentable;
- the patents of others may harm YS Group's business; and
- YS Group may choose not to file a patent in order to maintain certain trade secrets or know how, and a third party may discover certain technologies containing such trade secrets or know how through independent R&D and/or subsequently file a patent covering such intellectual property.

Should any of these events occur, it could have a material adverse effect on YS Group's business, financial condition, results of operations and prospects.

Risks related to YS Group's General Operations

YS Group could be adversely affected by the ongoing global impacts and uncertainties of the COVID-19 pandemic or similar pandemics in the future.

Beginning in early 2020, there was an outbreak of a novel strain of coronavirus, COVID-19. Governments across the world took a number of actions, including imposing restrictive policies which were designed to limit intercity or cross-border travels, request to remain at home and avoid public gatherings and encourage work-from-home arrangements, among other actions.

Many of the restrictive measures previously adopted by the PRC governments at various levels to control the spread of the COVID-19 virus were revoked or replaced with more flexible measures since December 2022. While the revocation or replacement of the restrictive measures to contain the COVID-19 pandemic could have a positive impact on YS Group's normal operations, it may also shift the public's interest in COVID-19 vaccines. Moreover, there has recently been and may continue to be an increase in COVID-19 cases in China, and as a result, YS Group experienced temporary disruption to YS Group's operations, including constraints and disruptions in the supplier chain, a significant number of employees being infected with COVID-19, and a decrease in output. The extent to which the COVID-19 pandemic impacts YS Group's business, prospects and results of operations will depend on future developments, which

are highly uncertain and cannot be predicted, including, but not limited to, the pace of the global economic recovery, shifts in supply chains, changes in market behavior, and adaptations to new norms in the post-pandemic world. The lingering impact of COVID-19 pandemic could limit the ability of customers, suppliers, vendors and business partners to perform their obligations. Even though the COVID-19 pandemic has subsided, difficult macroeconomic conditions, such as decreases in per capita income and level of disposable income, increased and prolonged unemployment or a decline in consumer confidence as a result of the COVID-19 pandemic, as well as reduced spending by businesses, could each have a material adverse effect on the demand for YS Group's products. YS Group cannot accurately forecast the potential impact of additional outbreaks, further shelter-in-place or other government restrictions implemented in response to such outbreaks, or the impact on the ability of YS Group's suppliers and other business partners to remain in business as a result of the lingering impact of the pandemic or any additional outbreaks.

YS Group has limited operating experience and management teams in the international market. YS Group's international expansion plan may expose YS Group to risks associated with international manufacturing, sales and operations.

YS Group has established R&D bases in China, the United States, Singapore and the Philippines, and may further expand its manufacturing, customer bases and operations globally. However, YS Group has limited operating experience and management teams in the international market. As of the date of this prospectus, YS Group is still at early stage in setting up its international operation for the sales, marketing and distribution of its immunological biologics. Managing an international organization is difficult, time-consuming and expensive. YS Group's lack of a track record in operating a business internationally increases the risk that any current or potential future international expansion efforts may not be successful. In addition, conducting international operations subjects YS Group to new risks that it has not generally faced. These risks that may materially adversely affect YS Group's ability to attain or sustain profitable operations include:

- localization of YS Group's products, including adaptation to local practices and regulatory requirements;
- production shortages resulting from any events affecting raw material supply or manufacturing capabilities abroad;
- efforts to enter into collaboration with third parties in connection with YS Group's international sales and operations that may increase its expenses or divert its management's attention from the acquisition or development of product candidates;
- changes in the political and cultural climate or economic condition of a specific country or region;
- lack of familiarity with and unexpected changes in applicable foreign regulatory regimes;
- difficulty of effective enforcement of contractual provisions in local jurisdictions;
- more extended accounts receivable payment cycles and difficulties in collecting payments;
- difficulties in managing and staffing overseas operations;
- compliance with tax, employment, immigration and labor laws for employees traveling abroad;
- workforce uncertainty and labor unrest;
- fluctuations in foreign currency exchange rates, which could result in increased operating expenses and reduced revenue, and other obligations incidental to doing business in another country or region;
- potentially adverse tax consequences, including the complexities of transfer pricing, foreign value-added tax systems and restrictions on the repatriation of earnings;
- unexpected changes in tariffs, trade barriers and regulatory requirements;
- dependence on certain third parties, such as local distributors or joint venture partners, with whom YS Group does not have extensive experience;
- potential third-party patent rights infringement and difficulties to enforce intellectual property rights;

[Table of Contents](#)

- increased financial accounting and reporting burdens and complexities;
- political, social, and economic instability abroad, including war and terrorism, and security concerns in general such as natural disasters; and
- reduced or varied protection for intellectual property rights in certain jurisdictions.

Operating in international markets also requires significant management attention and financial resources. YS Group cannot assure you that the investment and additional resources required to establish operations and manage growth in other countries would produce anticipated levels of revenue or profitability, and that any international expansion would be successful and would not have a material adverse effect on YS Group's business, financial condition and results of operations.

YS Group faces certain risks related to its real properties.

YS Group leases multiple real properties in several countries from third parties. Should disputes arise due to YS Group's use of or title encumbrances on such property or government action, YS Group may encounter difficulties in continuing to lease such property and may be required to relocate. As of the date of this prospectus, YS Group is not aware of any claim or challenge brought by any third party or governmental authority concerning the use of such leased property. YS Group cannot assure you that in the future, it may not encounter such challenges. In addition, in the event of relocation, YS Group may incur additional costs and face logistical complexities, reestablishment of business relationships, and operational disruption, which could adversely affect its daily operation and cause an impact on YS Group's financial condition.

In addition, as a vaccine manufacturing enterprise, YS Group currently holds certain parcel of lands to expand its manufacturing or R&D capacities. Under current PRC laws and regulations, if YS Group fails to commence the construction for more than one year from the commencement date stipulated in the land use right grant contracts, the relevant PRC land bureau may serve an investigation notice and impose an idle land fee of up to 20% of the land use right premium on YS Group unless the delay is caused by government actions or force majeure. If YS Group fails to commence the construction for more than two years, the land may be subject to forfeiture by the PRC government unless the delay is caused by government actions or force majeure. In addition to the administrative penalties, YS Group may be subject to civil liability as stipulated under the contracts. YS Group cannot assure you that it is and will be fully in compliance with the obligations under the land use right grant contract or listing-for-sale letters in the future due to factors which are beyond YS Group's control. If YS Group fails to comply with the terms of any land grant contract or listing-for-sale confirmation letter as a result of delays in any reasons other than government actions or force majeure, YS Group may have financial loss or lose its previous investments in the land, which may have a material adverse effect on its business, results of operations and financial condition.

Moreover, YS Group is required to obtain a series of approval, filing, permit or license before YS Group commences the construction under PRC laws and regulations. As of the date of this prospectus, YS Group has commenced construction or improvement of certain facilities and their use before obtaining the relevant approvals, permits and filings or going through the requisite procedures regarding, among others, construction, environmental protection, fire prevention and safety conditions. YS Group cannot assure you that it has obtained and fully complied with, or will be able to obtain and fully comply with, such approvals, filings, permits, licenses or other requisite procedures. If YS Group is found to be non-compliant with relevant laws and regulations, the relevant authorities may suspend or halt YS Group's construction or production as well as impose fines and penalties. For example, in case YS Group failed to obtain the relevant approval from environmental authorities, if necessary, for its construction projects before its construction activities, a fine up to 5% of the total investment amount of such construction project might be imposed on YS Group. Any non-compliance of relevant requirements on, including but not limited to construction, environmental protection, fire prevention and safety conditions, may adversely affect YS Group's results of operations and financial condition.

YS Group may be subject to fines and penalties under applicable PRC laws and regulations for failure to make adequate contributions to social insurance and housing reserve fund for its employees.

Pursuant to relevant PRC laws and regulations, employers are obligated to directly and duly make social insurances and housing reserve fund contributions for their employees. YS Group cannot assure you that its employment practice has been and will at all times be deemed to be in full compliance with labor-related laws and regulations in China, which may subject YS Group to labor disputes or government investigations and administrative penalties. If YS Group is deemed to have violated relevant labor laws and regulations, YS Group could be required to provide additional compensation to its employees or pay penalties, and YS Group's reputation, business, financial condition and results of operations could be materially and adversely affected. Historically, YS Group did not make adequate social insurance and housing provident fund contributions for its employees as required by the relevant PRC laws and regulations.

YS Group rectified the issue and made adequate social insurances and housing reserve fund contributions for all of its eligible employees. YS Group paid all the overdue principal and late charges in relation to its social insurances and housing reserve fund contributions for all current employees and certain former employees, and YS Group is communicating with the remaining former employees to complete the administrative procedure as the prerequisite for making such payments as of the date of this prospectus. YS Group also made provision for the historical inadequate contributions in its financial statements. As of the date of this prospectus, YS Group is not aware of any pending orders or demands from the relevant PRC government authorities requesting YS Group to pay these unpaid contributions, complete the registration or pay any penalties. If the relevant PRC government authorities order YS Group to make the outstanding contributions or impose penalties on it, or if YS Group's provision in its financial statements turns out to be insufficient, YS Group's business, financial condition and results of operations could be adversely affected. As the interpretation and implementation of labor-related laws and regulations are still evolving, YS Group cannot assure you that its current employment practices do not and will not violate labor-related laws and regulations in China, which may subject it to labor disputes or government investigations. In addition, it may incur additional expenses in order to comply with such laws and regulations, which may adversely affect its business and profitability.

Enhanced scrutiny over acquisition transactions by the PRC tax authorities may have a negative impact on potential acquisitions YS Group may pursue in the future.

Pursuant to the Notice on Strengthening Administration of Enterprise Income Tax for Share Transfers by Non-PRC Resident Enterprises ("SAT Circular 698"), issued by the PRC's State Taxation Administration, or the SAT, on December 10, 2009, where a foreign investor transfers the equity interests of a resident enterprise indirectly via disposition of the equity interests of an overseas holding company, or an "indirect transfer," and such overseas holding company is located in a tax jurisdiction that (1) has an effective tax rate less than 12.5% or (2) does not tax foreign income of its residents, the foreign investor shall report the indirect transfer to the competent PRC tax authority. The PRC tax authority will examine the true nature of the indirect transfer, and if the tax authority considers that the foreign investor has adopted an "abusive arrangement" in order to avoid PRC tax, it may disregard the existence of the overseas holding company and re-characterize the indirect transfer and as a result, gains derived by the non-PRC tax resident enterprises from such indirect transfer may be subject to PRC withholding tax at a rate of up to 10%.

On February 3, 2015, the SAT issued the Announcement of the State Administration of Taxation on Several Issues Concerning the Enterprise Income Tax on Indirect Property Transfer by Non-Resident Enterprises ("SAT Bulletin 7") to supersede existing provisions in relation to the "indirect transfer" as set forth in SAT Circular 698, while the other provisions of SAT Circular 698 remained in force. Pursuant to SAT Bulletin 7, where a non-resident enterprise indirectly transfers properties such as equity in PRC resident enterprises without any justifiable business purposes and aiming to avoid the payment of enterprise income tax, such indirect transfer must be reclassified as a direct transfer of equity in PRC resident enterprise. To assess whether an indirect transfer of PRC taxable properties has reasonable commercial purposes, all arrangements related to the indirect transfer must be considered comprehensively and factors set forth in SAT Bulletin 7 must be comprehensively analyzed in light of the actual circumstances.

On October 17, 2017, the SAT issued the Announcement of the State Administration of Taxation on Matters Concerning Withholding of Income Tax of Non-resident Enterprises as Source ("SAT Bulletin 37"), which repealed the entire SAT Circular 698 and the provision in relation to the time limit for the withholding agent to declare to the competent tax authority for payment of such tax of SAT Bulletin 7. Pursuant to SAT Bulletin 37, the income from a property transfer, as stipulated in the second item under Article 19 of the Enterprise Income Tax Law, shall include the income derived from transferring such equity investment assets as stock equity. The balance of deducting the equity's net value from the total income from equity transfer shall be taxable income from equity transfer. Where a withholding agent enters

[Table of Contents](#)

into a business contract, involving the income specified in the third paragraph of Article 3 in the Enterprise Income Tax Law, with a non-resident enterprise, the tax-excluding income of the non-resident enterprise will be treated as the tax-including income, based on which the tax payment will be calculated and remitted, if it is agreed in the contract that the withholding agent shall assume the tax payable.

During the effective period of SAT Circular 698 and by the application of SAT Bulletin 7 and SAT Bulletin 37, some intermediary holding companies were actually looked through by the PRC tax authorities, and consequently the non-PRC resident investors were deemed to have transferred the PRC subsidiary and PRC corporate taxes were assessed accordingly. It is possible that YS Group or its non-PRC resident investors may at some point be at risk of being taxed under SAT Bulletin 7 and SAT Bulletin 37 and may be required to expend valuable resources to comply with SAT Bulletin 7 and SAT Bulletin 37 or to establish that YS Group or its non-PRC resident investors should not be taxed under SAT Bulletin 7 and SAT Bulletin 37, which may have an adverse effect on YS Group's financial condition and results of operations or such non-PRC resident investors' investment in YS Group.

YS Group depends substantially on the continuing efforts of its senior executives, key R&D personnel and commercialization personnel, and YS Group's business and prospects may be severely disrupted if YS Group loses their services or if the relationship between YS Group and any of them deteriorates.

YS Group's future success depends heavily upon the continued service of its senior management and key R&D and commercialization personnel. For example, YS Group relies on the expertise and experience of Mr. Yi Zhang, YS Group's founder and director in YS Group's business operations, and on his positive relationships with the regulatory authorities, YS Group's customers, suppliers and employees. Any disagreement between Mr. Yi Zhang and YS Group's management team on major issues may divert Mr. Zhang and our management's attention and may have negative impact on YS Group's results of operations. For example, on December 22, 2023, the Grand Court of the Cayman Islands (the "Cayman Court") granted the Company an injunction order (the "Injunction Order") against Mr. Yi Zhang, ordering that Mr. Zhang is restrained from the following activities: (i) taking any steps to convene an extraordinary general meeting of the Company, either pursuant to the Notices for Removal of Director dated December 17, 2023 or any purported notice of an extraordinary general meeting scheduled to be held on December 28, 2023 at 9:00 a.m. Beijing time or at all; (ii) taking any steps to exercise any powers of, or hold himself out to be, chairperson of the Board; (iii) exercising any voting or other rights attaching to any shares in the Company that he owns or controls (whether directly or indirectly, through one or more intermediate entities or otherwise) or otherwise arising by virtue of his status as a member of the Company (whether directly or indirectly, through one or more intermediate entities or otherwise) to cause any of the Company's directors to be removed; and (iv) exercising any voting or other rights attaching to any shares in the Company that he owns or controls (whether directly or indirectly, through one or more intermediate entities or otherwise) or otherwise arising by virtue of his status as a member of the Company (whether directly or indirectly, through one or more intermediate entities or otherwise) to take other steps to stifle any investigations into his alleged wrongdoing. The Injunction Order will remain in force until the earlier of: (a) any further order of the Cayman Court varying or discharging the Injunction Order (including at the return date of the injunction summons); or (b) 5:00 a.m. Beijing time on February 10, 2024. In December 2023, the Board has established a special committee comprised of Dr. Ajit Shetty, Dr. Viren Mehta and Dr. Hui, with powers and authorities to, among other things, commence legal proceedings in the Cayman Islands regarding invalid actions to convene an extraordinary general meeting of the Company. While Mr. Zhang has been a key figure in the Company, his recent actions and the resulting legal constraints highlight underlying vulnerabilities within YS Group's governance and operational structures. His attempts to unilaterally influence Company decisions and disrupt normal operations demonstrate a risk to the Company's adherence to sound governance principles. The Company must now navigate the challenges of continuing operations while managing the fallout from Mr. Zhang's actions. While the situation poses challenges to the Company's reputation, it also offers a chance to demonstrate YS Group's commitment to ethical standards and corporate responsibility. The Company must be prepared for the potential legal and financial implications arising from Mr. Zhang's actions. This includes the need for increased legal vigilance and potentially allocating resources to address any legal challenges or reputational damages caused by his conduct.

YS Group also relies on the healthcare industry-related experience and professional knowledge of its other senior officers. YS Group's R&D team is critical to the development and commercialization of product candidates and realization of the potential benefits of its intellectual property, including YS Group's proprietary PIKA immunomodulatory technology platform. YS Group's ability to attract and retain key personnel, in particular, senior management, key R&D personnel and commercialization personnel, is a critical aspect of its competitiveness. Competition for these individuals could require YS Group to offer higher compensation and other benefits in order to attract and retain them,

[Table of Contents](#)

which would increase its operating expenses and, in turn, could materially and adversely affect its results of operations and financial condition. YS Group may be unable to attract or retain the personnel required to achieve its business objectives, and failure to do so could severely disrupt its business and prospects. The loss of any of YS Group's key employees, including senior executives, key R&D personnel or commercialization personnel, could materially harm its business and prospects.

YS Group does not maintain key-person insurance for members of its management team. If YS Group loses the services of any senior management member, YS Group may not be able to locate suitable or qualified replacements, and may incur additional expenses to recruit and train new personnel, which could severely disrupt YS Group's business and prospects. Furthermore, if any of YS Group's executive officers joins a competitor or forms a competing company, YS Group may lose a significant number of its existing customers, which could have a material adverse effect on YS Group's business and revenues. Although each of YS Group's executive officers has entered into an agreement with YS Group that contains confidentiality and non-competition undertakings regarding their employment, disputes may arise between YS Group's executive officers and YS Group, and these agreements may not be enforced in accordance with their terms.

YS Group may pursue collaborations, in-licensing arrangements, joint ventures, strategic alliances, partnerships or other strategic investment or arrangements, which may fail to produce anticipated benefits and adversely affect YS Group's business.

YS Group collaborates with research organizations and government agencies to supplement its in-house efforts and advance the development of its product candidates. YS Group may pursue other opportunities for collaboration, in-licensing, joint ventures, acquisitions of products, assets or technology, strategic alliances, or partnerships that YS Group believes would be complementary to or promote its existing business. However, initiating, negotiating, and finalizing these potential transactions can be a long-drawn, complex process filled with uncertainties. Other companies, including those with substantially greater financial capacity, marketing networks, technological capabilities, business expertise, or other business or governmental resources, may compete with YS Group for these opportunities or arrangements. Consequently, these organizations may be in a stronger position to pursue and secure the same opportunities YS Group is interested in, putting YS Group at a competitive disadvantage. Moreover, identifying suitable opportunities or arrangements that align with YS Group's strategic objectives can be challenging and may require a significant amount of time and resources. Even after identifying a potential opportunity, YS Group may not be able to identify, secure, or complete any such transactions or arrangements in a timely manner, on a cost-effective basis, on acceptable terms, or at all.

YS Group has limited experience with respect to these business development activities. Management and integration of a licensing arrangement, collaboration, joint venture or other strategic arrangement may disrupt YS Group's current operations, decrease YS Group's profitability, result in significant expenses, or divert management resources that otherwise would be available for its existing business. YS Group may not realize the anticipated benefits of any such transaction or arrangement.

Furthermore, partners, collaborators or other parties to such transactions or arrangements may fail to fully, or at all, perform their obligations or meet YS Group's expectations or cooperate with YS Group satisfactorily for various reasons, including risks or uncertainties related to their business and operations. There may be conflicts or other collaboration failures and inefficiencies between YS Group and the other parties.

Such transactions or arrangements may also require actions, consents, approvals, waivers, participation or involvement of various degrees from third parties, such as regulators, government authorities, creditors, licensors or licensees, related individuals, suppliers, distributors, shareholders or other stakeholders or interested parties. There is no assurance that such third parties will be cooperative as YS Group desires, or at all, in which case YS Group may be unable to carry out the relevant transactions or arrangements.

Any transaction YS Group undertakes would need to be integrated with YS Group's current operations. Integration issues, including business limitations, culture clashes, unanticipated costs, undisclosed liabilities, and loss of key employees, can impede YS Group's operational efficiency and productivity, thereby adversely affecting its business, results of operations and financial condition.

YS Group may not be able to complete new acquisitions successfully. Even if YS Group successfully acquires companies, products or technologies, YS Group may face integration risks and costs associated with those acquisitions that could negatively impact its business, financial condition and results from operations.

Acquisitions have been, and are expected to continue to be, an important part of YS Group's growth strategies. For example, YS Group has established its proprietary PIKA immunomodulatory technology platform through the acquisition of NewBiomed in June 2010. If YS Group is presented with appropriate opportunities, YS Group may make additional acquisitions of complementary businesses, products, product candidates or technologies. Any such acquisitions will be dependent upon the continued availability of suitable acquisition targets at favorable prices and upon advantageous terms and conditions. Even if such opportunities are present, YS Group may not be able to successfully identify such acquisition targets. Moreover, other companies, many of which may have substantially greater financial, marketing, governmental and sales resources, are competing with YS Group for the right to acquire such businesses, products, product candidates, qualifications or technologies. If an acquisition target is identified, the management and shareholders of the acquisition target may not select YS Group as a potential partner or YS Group may not be able to enter into agreements on commercially reasonable terms or at all. Furthermore, the negotiation and completion of potential acquisitions could cause significant diversion of YS Group's management's time and resources and potential disruption of its ongoing business.

In addition, YS Group cannot assure you it will realize the anticipated benefit of any acquisition or investment. If YS Group acquires companies or technologies, YS Group will face risks, uncertainties and disruptions associated with the integration process, including difficulties in the integration of the operations of an acquired company, integration of acquired technology with its products, diversion of its management's attention from other business concerns, the potential loss of key employees or customers of the acquired business, the potential involvement in any litigation related to the acquired company, and impairment charges if acquisitions are not as successful as YS Group originally anticipate. In addition, YS Group's results of operations may suffer because of acquisition-related costs or amortization expenses or charges relating to acquired intangible assets. As of March 31, 2022 and 2023 and September 30, 2023, YS Group had RMB80.7 million, RMB78.1 million (\$11.4 million) and RMB74.6 million (\$10.4 million) in intangible assets, respectively. Any failure to successfully integrate other companies, products, qualifications or technologies that YS Group may acquire may have a material adverse effect on its business, financial condition and results of operations.

YS Group will likely need substantial additional funding for its new and existing product development programs and commercialization efforts, which may not be available on acceptable terms, or at all. If YS Group is unable to raise capital on acceptable terms when needed, YS Group could incur losses or be forced to delay, reduce or terminate such efforts.

YS Group's operations have consumed substantial amounts of cash since inception. The net cash used in YS Group's operating activities was RMB246.6 million, RMB173.5 million, RMB182.5 million (\$26.6 million) and RMB145.8 million (\$20.3 million) for the fiscal year ended March 31, 2021, 2022 and 2023 and the six months ended September 30, 2023, respectively. YS Group expects its expenses to increase in connection with YS Group's ongoing activities, particularly as YS Group launch and expand the sale of YSJA™ rabies vaccine, advance the clinical trial of its product candidates and continue R&D of its preclinical stage product candidates, and initiate additional clinical trials of, and seek regulatory approval for, these and other future product candidates. In addition, if YS Group obtain regulatory approval for any of its product candidates, it expects to incur significant commercialization expenses related to product manufacturing, marketing and sales. In particular, the costs that may be required for the manufacture of any product candidate that receives regulatory approval may be substantial as YS Group may have to modify or increase the production capacity at its current manufacturing facilities or contract with third-party manufacturers or suppliers, increase labor capacity and insurance coverage, acquire and maintain new equipment and upgrade YS Group's budget on other manufacture-associated procedures such as waste management and product storage. YS Group may also incur expenses as it creates additional infrastructure to support its operations as a public company. Accordingly, YS Group will likely need to obtain substantial additional funding in connection with its continuing operations through public or private equity offerings, debt financing, collaborations or licensing arrangements or other sources.

YS Group's ability to obtain additional capital in the future is subject to a variety of uncertainties, including:

- YS Group's future financial condition, results of operations, outcomes of ongoing R&D, and cash flows;
- the condition of U.S. and other capital markets in which YS Group may seek to raise funds;

[Table of Contents](#)

- investors' perception of, and demand for, securities of biopharmaceutical companies;
- economic, political and other conditions or crises in China and elsewhere;
- regulatory changes;
- availability of government grants and incentives; and
- considerations of tax, interest rates, competition, potential or ongoing litigations.

If YS Group is unable to raise capital when needed or on acceptable terms, it could incur losses and be forced to delay, reduce or terminate its R&D programs or any future commercialization efforts. If YS Group raises additional capital through the sale of equity or convertible debt securities, your ownership interest will be diluted, and the terms may include liquidation or other preferences that adversely affect your rights. The incurrence of additional indebtedness or the issuance of certain equity securities could result in increased fixed payment obligations and could also result in certain additional restrictive covenants, such as limitations on YS Group's ability to incur additional debt or issue additional equity, limitations on YS Group's ability to acquire or license intellectual property rights and other operating restrictions that could adversely impact YS Group's ability to conduct its business. In addition, issuance of additional equity securities, or the possibility of such issuance, may cause the market price of YS Group's Shares to decline.

Any catastrophe, including outbreaks of health pandemics and other extraordinary events, could have a negative impact on YS Group's business operations.

YS Group is vulnerable to natural disasters and other calamities. Fire, floods, typhoons, earthquakes, power loss, telecommunications failures, break-ins, war, riots, terrorist attacks or similar events may give rise to server interruptions, breakdowns, system failures or Internet failures, which could cause the loss or corruption of data or malfunctions of software or hardware as well as adversely affect YS Group's ability to provide its services. YS Group's vulnerability to such natural disasters and other calamities also extends to YS Group's physical facilities, equipment and other properties, resulting in significant disruptions to its operations, delay or halt the production of its products, hinder the progress of its R&D, and cause loss of critical data. Moreover, such events could also affect its supply chain, leading to shortages of necessary materials or components. Inadequate insurance coverage or lack of resources to repair or replace the damaged facilities, equipment or other properties could exacerbate these challenges, significantly impacting its business financial condition and results of operations.

YS Group's business could also be adversely affected by the effects of Ebola virus diseases, H1N1 flu, H7N9 flu, avian flu, Severe Acute Respiratory Syndrome (SARS), COVID-19, or other existing or emerging epidemics in China and globally. YS Group's operations could be disrupted if any of its employees is suspected of having any of the aforementioned epidemics or another contagious disease or condition, since it could require YS Group's employees to be quarantined and/or YS Group's offices to be disinfected. In addition, YS Group's business, results of operations and financial condition could be adversely affected to the extent that any of these epidemics harms the Chinese economy in general. For example, the outbreak, rapid spread, as well as the exacerbation, continuance or reoccurrence of COVID-19 throughout China and many other parts of the world since 2019 have already caused and may continue to cause an adverse and prolonged impact on the economy and social conditions in China and other affected countries. The existing clinical trials and the commencement of new clinical trials could be substantially disrupted, delayed or prevented by any delay or failure in patient recruitment or enrollment in YS Group's or YS Group's collaborators' trials as a result. The existing clinical trials and the commencement of new clinical trials could be substantially disrupted, delayed or prevented by any delay or failure in patient recruitment or enrollment in YS Group's or YS Group's collaborators' trials as a result. The quality of YS Group's clinical trials can also be substantially and negatively affected or be subject to uncertainties due to the ongoing impact of COVID-19. These factors could cause delay of clinical trials, regulatory submissions, and required approvals of YS Group's product candidates, and could cause YS Group to incur additional costs. If YS Group's employees or employees of YS Group's business partners are suspected of being infected with an epidemic disease, YS Group's operations may be disrupted because YS Group or YS Group's business partners must quarantine some or all of the affected employees or disinfect the operating facilities. If YS Group is not able to effectively develop and commercialize its product candidates as a result of protracted clinical trials of enrolled patients, elevated public health safety measures, and/or failure to recruit and conduct patient follow-up, YS Group may not be able to generate revenue from sales of its product candidates or licensing YS Group's technologies as planned. All of the foregoing could have a material adverse effect on YS Group's results of operations and financial condition in the near term.

A severe or prolonged downturn in Chinese or global economy could materially and adversely affect YS Group's business, results of operations, financial condition and prospects.

While the global situation concerning COVID-19 has improved considerably due to widespread vaccination efforts and implementation of public health measures, there could still be potential repercussions from new variants of the virus, as well as uncertainties about the effectiveness and duration of existing marketed vaccines, which could influence future economic stability. Overall, its long-term effects on the global economy and specific sectors remain unclear. Even before the outbreak of COVID-19, the global macroeconomic environment was facing numerous challenges. The growth rate of the Chinese economy has been slowing since 2010, and the impact of COVID-19 on the Chinese economy in 2020 is likely to be severe. There is considerable uncertainty over the long term effects of the expansionary monetary and fiscal policies which had been adopted by the central banks and financial authorities of some of the world's leading economies, including the United States and China, even before 2020. Unrest, terrorist threats and the potential for war in the Middle East, Ukraine, Russia and elsewhere may increase market volatility across the globe. There have also been concerns about the relationship between China and other countries, including the surrounding Asian countries, which may potentially have economic effects. In particular, there is significant uncertainty about the future relationship between the United States and China with respect to trade policies, treaties, government regulations and tariffs. Economic conditions in China are sensitive to global economic conditions, as well as changes in domestic economic and political policies and the expected or perceived overall economic growth rate in China. Any severe or prolonged slowdown in the global or Chinese economy may materially and adversely affect YS Group's business, results of operations and financial condition.

YS Group may seek orphan drug exclusivity for some of its product candidates, which may not be successful.

Regulatory authorities in some jurisdictions, including the United States, may designate drugs for relatively small patient populations as orphan drugs. Under the Orphan Drug Act, the U.S. FDA may designate a drug as an orphan drug if it is a drug intended to treat a rare disease or condition, which is generally defined as a disease with a patient population of fewer than 200,000 individuals in the United States. Generally, if a drug with an orphan-drug designation ("ODD") subsequently receives the first regulatory approval for the indication for which it has such designation, the drug is entitled to a period of marketing exclusivity, which precludes the U.S. FDA, from approving another marketing application for the same drug for the same indication during the period of exclusivity. The applicable period varies in different jurisdictions, which is seven years in the United States. Orphan drug exclusivity may be lost if the U.S. FDA determines that the request for designation was materially defective or if the manufacturer is unable to assure sufficient quantity of the drug to meet the needs of patients with the rare disease or condition.

YS Group obtained ODD for certain of its product candidates, including PIKA rabies vaccine and PIKA YS-ON-001. However, such designation cannot completely protect this product from future competition. The exclusivity may not effectively protect YS Group's product candidates from competition because different drugs can be approved for the same condition and the same drugs can be approved for a different condition but used off-label for any orphan indication YS Group may obtain. Even after an orphan drug is approved, the U.S. FDA can subsequently approve a different drug for the same condition if the U.S. FDA concludes that the later drug is clinically superior in that it is shown to be safer, more effective or makes a major contribution to patient care.

The incidence and prevalence for target patient populations of YS Group's product candidates are based on estimates and third-party sources. If the market opportunities for YS Group's product candidates are smaller than it estimates or if any approval that YS Group obtains is based on a narrower definition of the patient population, YS Group's revenue and ability to achieve profitability might be materially and adversely affected.

YS Group makes periodical estimates regarding the incidence and prevalence of target patient populations for particular diseases based on various third-party sources and internally generated analysis and use such estimates in making decisions regarding YS Group's products development strategy, including acquiring or in-licensing products candidates and determining indications on which to focus in preclinical or clinical trials.

These estimates may be inaccurate or based on imprecise data. For example, the total addressable market opportunity will depend on, among other things, their acceptance by the medical community and patient access, pricing and reimbursement. The number of patients in the addressable markets may turn out to be lower than expected, patients may not be otherwise amenable to treatment with YS Group's products, or new patients may become increasingly difficult to identify or gain access to, all of which may significantly harm YS Group's business, financial condition, results of operations and prospects.

Risks Related to Doing Business in China

Recent regulatory development in China may exert more oversight and control over listing and offerings that are conducted overseas. The approval, filing, and/or other requirements of PRC governmental authorities may be required under PRC laws, regulations or policies.

YS Group conducts a substantial portion of its business in China, including manufacturing and sales of YSJA™ rabies vaccines and certain R&D activities. As such, YS Biopharma and its subsidiaries are subject to PRC laws relating to, among others, restrictions over overseas listing, foreign investments and data security.

Under the current Regulations on Mergers and Acquisitions of Domestic Companies by Foreign Investors adopted by six PRC regulatory agencies, including the Ministry of Commerce of the PRC (“MOFCOM”), the State-Owned Assets Supervision and Administration Commission, the SAT, the State Administration for Industry and Commerce, currently known as the SAMR, the CSRC, and the SAFE in 2006 and amended in 2009 (the “M&A Rules”) include provisions that purport to require that an offshore special purpose vehicle that is controlled by PRC domestic companies or individuals and that has been formed for the purpose of an overseas listing of securities through acquisitions of PRC domestic companies or assets to obtain the approval of the CSRC prior to the listing and trading of such special purpose vehicle’s securities on an overseas stock exchange. On September 21, 2006, the CSRC published its approval procedures for overseas listings by special purpose vehicles. However, substantial uncertainty remains regarding the scope and applicability of the M&A Rules to offshore special purpose vehicles.

The Chinese government has recently sought to exert more control and impose more restrictions on China-based companies raising capital offshore and such efforts may continue or intensify in the future. On August 1, 2021, the CSRC stated in a statement that it had taken note of the new disclosure requirements announced by the SEC regarding the listings of Chinese companies and the recent regulatory development in China, and that both countries should strengthen communications on regulating China-related issuers.

On February 17, 2023, the CSRC issued the Trial Administrative Measures for Overseas Listing and five supporting guidelines, which came into effect on March 31, 2023. According to the Trial Administrative Measures for Overseas Listing, a filing-based regulatory regime is adopted to regulate both direct and indirect overseas securities offering and listing by the domestic companies. The Trial Administrative Measures for Overseas Listing provide the criteria of indirect overseas offering and listing by domestic companies that are subject to regulation. If the issuer meets both the following criteria, it will be deemed as indirect overseas offering and listing by domestic companies: (1) 50% or more of any of the issuer’s operating revenue, total profit, total assets or net assets as documented in its audited consolidated financial statements for the most recent fiscal year is accounted for by domestic companies; and (2) the main parts of the issuer’s business activities are conducted in mainland China, or its principal place(s) of business are located in China, or the majority of senior management staff in charge of its business operations and management are PRC citizens or domiciled in China. The determination as to whether or not an overseas offering and listing by domestic companies is indirect, shall be made on a substance-over-form basis. The Trial Administrative Measures for Overseas Listing require that, subsequent securities offerings of an issuer in the same overseas market where it has previously offered and listed securities shall be filed with the CSRC within three working days after the offering is completed and issuer that conducts its offering and subsequent securities offering and listing in other overseas markets shall be filed as an initial public offering, under which filing application with the CSRC shall be submitted within three working days after the application documents for offering and listing being submitted overseas. Further, a domestic company that seeks to directly or indirectly list its domestic assets in overseas markets through single or multiple acquisitions, share swaps, transfers of shares or other means, shall fulfil the filing procedure as an initial public offering. Where overseas application documents are not required, the filing shall be made within three working days after the first public disclosure of the specifics of the transaction is made by the listed company. In addition, pursuant to the CSRC press release regarding the Trial Administrative Measures for Overseas Listing published on its official website on February 17, 2023, a company having listed overseas before the effectiveness of the Trial Administrative Measures for Overseas Listing would only be subject to the filing requirements when conducting a follow-on offering of securities.

Given that YS Group had completed the Business Combinations and the listing of its Ordinary Shares on Nasdaq before the Trial Administrative Measures for Overseas Listing went into effect, YS Group is not required to undergo the filing procedures with the CSRC in connection with these transactions. Additionally, YS Biopharma would not additionally issue any new share or other equity securities from the Resale by the Selling Securityholders, YS Biopharma believes that, as advised by its PRC legal advisor, the Resale by the Selling Securityholders is not subject to the filing

requirements prescribed in the Trial Administrative Measures for Overseas Listing. However, given that the Trial Administrative Measures for Overseas Listing were recently promulgated, there remains substantial uncertainties as to their interpretation, application, and enforcement, and there is no guarantee that the relevant PRC government agencies, including the CSRC, would reach the same conclusion as YS Biopharma and its PRC legal advisor. For YS Group's future capital-raising activities, if YS Biopharma fails to receive or maintain any requisite approval or filing from the CSRC, or the waiver for such approval or filing, in a timely manner, or at all, or inadvertently conclude that such approval or filing is not required, or if applicable laws, regulations or interpretations change and obligate YS Biopharma to obtain such approval or filing in the future, or YS Biopharma conceals any material fact or falsifies any major content in the filing documents, YS Biopharma may be subject to rectifications, warnings, fines and penalties, limitations on YS Group's business activities in China, delay or restrictions on the contribution of the proceeds from further offerings into the PRC, or other sanctions that could have a material adverse effect on YS Group's business, financial condition, results of operations, reputation and prospects. The CSRC may also take actions requiring or YS Group or making it advisable for YS Group to terminate future offerings. Such uncertainties and/or negative publicity regarding such requirements could cause YS Biopharma's securities to decline significantly in value or become worthless.

Moreover, on November 14, 2021, the CAC released the Regulations for the Administration of Network Data Security (Draft for Comment) (the "Draft Administrative Regulation"). Under the Draft Administrative Regulation, (1) data processors, i.e., individuals and organizations who can decide on the purpose and method of their data processing activities at their own discretion, that process personal information of more than one million individuals shall apply for cybersecurity review before listing in a foreign country; (2) foreign-listed data processors shall carry out annual data security evaluation and submit the evaluation report to the municipal cyberspace administration authority; and (3) where the data processor undergoes merger, reorganization and subdivision that involves important data and personal information of more than one million individuals, the recipient of the data shall report the transaction to the in-charge authority at the municipal level. The public comment period for the Draft Administrative Regulation ended on December 13, 2021, and the Draft Administrative Regulation has not come into effect as of the date of this prospectus. On December 28, 2021, the PRC government promulgated the 2022 Cybersecurity Review Measures, which came into effect on February 15, 2022. According to the 2022 Cybersecurity Review Measures, (i) critical information infrastructure operators that purchase network products and services and internet platform operators that conduct data processing activities shall be subject to cybersecurity review in accordance with the 2022 Cybersecurity Review Measures if such activities affect or may affect national security; and (ii) internet platform operators holding personal information of more than one million users and seeking to have their securities list on a stock exchange in a foreign country shall file for cybersecurity review with the Cybersecurity Review Office. As of the date of this prospectus, neither YS Group/YS Biopharma nor any of its subsidiaries has been required by any PRC governmental authority to apply for cybersecurity review, nor received any inquiry, notice, warning, sanction in such respect or been denied permission from any PRC regulatory authority to list on U.S. exchanges. Based on the opinion of YS Biopharma's PRC counsel, Jingtian & Gongcheng, according to its interpretation of the currently in-effect PRC laws and regulations, YS Group believes it is not subject to the cybersecurity review, reporting or other permission requirements by the CAC under the applicable PRC cybersecurity laws and regulations with respect to the offering of YS Biopharma's securities for the Business Combination or the business operations of YS Group's PRC subsidiaries, because YS Group/YS Biopharma or its PRC subsidiaries does not qualify as a critical information infrastructure operator or internet platform operator, or has conducted any data processing activities that affect or may affect national security or holds personal information of more than one million users. However, as PRC governmental authorities have significant discretion in interpreting and implementing statutory provisions and there remains significant uncertainty in the interpretation and enforcement of relevant PRC cybersecurity laws and regulations, YS Group cannot assure you that the Business Combination and business operation of YS Group/YS Biopharma or any of its PRC Subsidiaries will not be deemed to be subject to PRC cybersecurity review requirements under the 2022 Cybersecurity Review Measures or the Draft Administrative Regulations as a critical information infrastructure operator, data processor or an internet platform operator that is engaged in data processing activities that affect or may affect national security or hold personal information of more than one million users, nor can YS Group assure you that YS Group/YS Biopharma or its PRC Subsidiaries would be able to pass such review. If YS Group/YS Biopharma or its PRC subsidiaries fail to receive any requisite permission or approval from the CAC for the Business Combination or the business operations of YS Group, or the waiver for such permission or approval, in a timely manner, or at all, or inadvertently conclude that such permission or approval is not required, or if applicable laws, regulations or interpretations change and obligate YS Group to obtain such permission or approvals, YS Group may be subject to increased compliance costs, fines, disruption or even suspension of business, revocation of business licenses or other penalties, as well as reputational

damage or legal proceedings or actions against YS Group, which may have a material adverse effect on the business, financial condition or results of operations of YS Group. Any of the foregoing events may also significantly limit or completely hinder YS Biopharma's ability to offer or continue to offer securities to investors and cause the value of such securities to significantly decline or in extreme cases, become worthless. In addition, YS Group could become subject to enhanced cybersecurity review or investigations launched by PRC regulators in the future pursuant to new laws, regulations or policies, which may increase YS Group's costs for compliance and divert its management's attention. Any failure or delay in the completion of the cybersecurity review procedures or any other non-compliance with applicable laws and regulations may result in fines, disruption or even suspension of business, revocation of business licenses or other penalties, as well as reputational damage or legal proceedings or actions against YS Group, which may have a material adverse effect on the business, financial condition or results of operations of YS Group.

YS Biopharma's securities may be delisted under the Holding Foreign Companies Accountable Act if the PCAOB is unable to inspect auditors with presence in China in 2023 and beyond, and the delisting of its securities, or the threat of their being delisted, may materially and adversely affect the value of your investment.

The Holding Foreign Companies Accountable Act ("HFCAA") was enacted on December 18, 2020 and has been subsequently amended. The HFCAA states if the SEC determines that a U.S. listed company has filed audit reports issued by a registered public accounting firm that has not been subject to inspection by the PCAOB for two consecutive years, the SEC shall prohibit its securities from being traded on a national securities exchange or in the over-the-counter trading market in the United States.

YS Biopharma's consolidated financial statements contained in this registration statement on Form F-1, of which this prospectus forms a part, have been audited by WWC, an independent registered public accounting firm that is headquartered in the United States. WWC is a firm registered with the PCAOB, and is required by the United States laws to undergo regular inspections by the PCAOB to assess its compliance with the laws of the U.S. and professional standards. While WWC has been inspected by the PCAOB on a regular basis, no overseas securities regulator is allowed to directly conduct investigation or evidence collection activities in China according to Article 177 of the PRC Securities Law. Accordingly, without the consent of the competent PRC securities regulators and relevant authorities, no organization or individual may provide the documents and materials relating to securities business activities in China to the PCAOB, an overseas securities regulator under the PRC Securities Law. As a result, the audit working papers of the financial statements in this prospectus may not be inspected by the PCAOB, since the audit work was carried out by WWC with the collaboration of their China-based offices and the PCAOB has not obtained such requisite approval. The trading of YS Biopharma's securities may be prohibited and such securities may be delisted from Nasdaq or any other U.S. stock exchange under the HFCAA if the PCAOB is unable to inspect auditors with presence in China. The prohibition of trading of YS Biopharma's securities and the delisting of the securities, or the threat of their being prohibited or delisted, may cause the value of such securities to significantly decline or, in extreme cases, become worthless.

On March 24, 2021, the SEC adopted interim final rules relating to the implementation of certain disclosure and documentation requirements of the HFCAA. On December 2, 2021, the SEC adopted amendments to finalize such rules, which include requirements to disclose information, including the auditor name and location, the percentage of shares of the issuer owned by governmental entities, whether governmental entities in the applicable foreign jurisdiction with respect to the auditor has a controlling financial interest with respect to the issuer, the name of each official of the Chinese Communist Party who is a member of the board of the issuer, and whether the articles of incorporation of the issuer contains any charter of the Chinese Communist Party. These amendments also establish procedures the SEC will follow in identifying issuers and prohibiting trading by certain issuers under the HFCAA, including that the SEC will identify an issuer as a "Commission-identified Issuer" if the issuer has filed an annual report containing an audit report issued by a registered public accounting firm that the PCAOB has determined it is unable to inspect or investigate completely, and will then impose a trading prohibition on an issuer after it is identified as a Commission-Identified Issuer for two consecutive years.

On December 16, 2021, the PCAOB issued a report to notify the SEC of its determination that it is unable to inspect or investigate completely PCAOB-registered public accounting firms headquartered in mainland China and Hong Kong without the approval of the Chinese authorities. While YS Biopharma's auditor, Wei, Wei & Co., LLP, is headquartered in the United States and not subject to such determinations, there is no guarantee that the audit work carried out by Wei, Wei & Co., LLP in collaboration with its China-based offices can be inspected or investigated completely by the PCAOB without such approval. YS Biopharma is required to comply with these rules if the SEC identifies

[Table of Contents](#)

YS Biopharma as having a “non-inspection” year by evaluating the annual report it files, in which it will identify the auditor who provide opinions related to the financial statements presented in its annual report, the location where the auditor’s report has been issued and the PCAOB ID number of such audit firm or branch. If YS Biopharma has two consecutive non-inspection years, the SEC will implement the trading prohibition of YS Biopharma’s securities through stop orders, and the exact timeline for when the SEC will delist an issuer after two consecutive non-inspection years remains imprecise. YS Biopharma’s securities could be prohibited from trading in the United States if it is identified as a Commission-identified Issuer for two consecutive years.

In March 2022, the SEC issued its first “conclusive list of issuers identified under the HFCAA” indicating that those companies are now formally subject to the delisting provisions if they remain on the list for two consecutive years.

In August 2022, the PCAOB, the CSRC and the Ministry of Finance of the PRC signed the Statement of Protocol, which establishes a specific and accountable framework for the PCAOB to conduct inspections and investigations of PCAOB-governed accounting firms in mainland China and Hong Kong. On December 15, 2022, the PCAOB announced that it was able to secure complete access to inspect and investigate PCAOB registered public accounting firms headquartered in mainland China and Hong Kong completely in 2022. The PCAOB Board vacated its previous 2021 determinations that the PCAOB was unable to inspect or investigate completely registered public accounting firms headquartered in mainland China and Hong Kong. However, whether the PCAOB will continue to be able to satisfactorily conduct inspections of PCAOB-registered public accounting firms headquartered in mainland China and Hong Kong is subject to uncertainties and depends on a number of factors out of YS Biopharma’s and YS Biopharma’s auditor’s control. The PCAOB continues to demand complete access in mainland China and Hong Kong moving forward and is making plans to resume regular inspections in early 2023 and beyond, as well as to continue pursuing ongoing investigations and initiate new investigations as needed. The PCAOB has also indicated that it will act immediately to consider the need to issue new determinations with the HFCAA if needed.

The HFCAA or other efforts to increase U.S. regulatory access to audit information could cause investor uncertainty for affected issuers, including YS Biopharma, and the market price of YS Biopharma’s securities could be adversely affected. If its auditor is unable to be inspected or it is unable to meet the PCAOB inspection requirement in time in 2023 and beyond, including retain a registered public accounting firm that the PCAOB is able to inspect, YS Biopharma would be identified as a “Commission-identified Issuer” and be delisted from the Nasdaq Stock Market upon the expiration of the applicable years of non-inspection under the HFCAA and YS Biopharma’s securities will not be permitted for trading “over-the-counter” either. If YS Biopharma’s securities are prohibited from trading in the United States, there is no certainty that YS Group will be able to list on a non-U.S. exchange or that a market for its shares will develop outside of the United States. The delisting would substantially impair your ability to sell or purchase YS Biopharma’s securities when you wish to do so, and the risk and uncertainty associated with delisting would have a negative impact on the price of YS Biopharma’s securities. In addition, the delisting would significantly affect YS Biopharma’s ability to raise capital on terms acceptable to it, or at all, which would have a material adverse impact on its business, financial condition, and prospects. If YS Biopharma’s securities are delisted from the Nasdaq Stock Market and are prohibited from trading in the over-the-counter market in the United States, there is no certainty that YS Biopharma will be able to list on a non U.S. exchange or that a market for YS Biopharma’s securities will develop outside of the United States.

PRC governmental authorities’ significant oversight and discretion over YS Group’s business operation could result in a material adverse change in its operations following the Business Combination and the value of YS Biopharma’s securities and YS Biopharma’s securities following the Business Combination.

PRC governmental authorities have significant oversight and discretion over YS Group’s business operations in China and may seek to intervene or influence such operations at any time the government deems appropriate to further its regulatory, political and societal goals, which could result in a material adverse change in its operations and/or the value of YS Biopharma’s securities. In addition, the PRC governmental authorities may also exert more oversight and control over offerings that are conducted overseas and/or foreign investment in China-based issuers. Any such action could result in a material change in YS Group’s operations, significantly limit or completely hinder the value of YS Biopharma’s securities and the ability of YS Biopharma to offer or continue to offer securities to investors, and cause the value of such securities to significantly decline or be worthless. Furthermore, occurrences of incidents or scandals within other companies in the same or similar industries that attract government scrutiny or national-level attention and the implementation of industry-wide regulations directly targeting the operations of YS Group could cause the value of YS Biopharma’s securities to decline significantly.

Changes in China's economic, political or social conditions or government policies could have a material adverse effect on YS Group's business and operations.

YS Group conducts a substantial portion of its business in China, including, manufacturing and sales of YSJA™ rabies vaccines and certain R&D activities. As such, YS Group's business, financial condition, results of operations and prospects may be influenced to a significant degree by political, economic, social and other conditions in China, including, among others, regulatory environment, overall economic growth, level of urbanization and level of per capita disposable income. The Chinese economy differs from the economies of most developed countries in many respects, including the level of government involvement, level of development, growth rate, control of foreign exchange and allocation of resources. Although the Chinese government has implemented various changes, a significant portion of the productive assets in China are owned by the government, and the Chinese government continues to play a significant role in regulating industry development by setting industrial policies. The Chinese government also exercises significant control over China's economic growth by allocating resources, controlling payment of foreign currency-denominated obligations, setting monetary policy and providing different treatment to particular industries or companies.

While the Chinese economy has experienced significant growth over past decades, growth has been uneven, both geographically and among various sectors of the economy. Any adverse changes in economic conditions in China, the policies of the Chinese government or the laws and regulations in China could have a material adverse effect on the overall economic growth of China. Such developments may lead to a reduction in demand for YS Group's marketed product or product candidates in the future and materially and adversely affect its business, financial condition and results of operations. In addition, stimulus measures designed to boost the Chinese economy may contribute to higher inflation, which could adversely affect YS Group's results of operations and financial condition.

A severe or prolonged downturn in the PRC or global economy and political tensions between the United States and China could materially and adversely affect YS Group's business and financial condition.

The global macroeconomic environment is facing challenges, including the end of quantitative easing by the U.S. Federal Reserve, the economic slowdown in the Eurozone since 2014 and uncertainties over the impact of Brexit. The Chinese economy has shown slower growth compared to the previous decade since 2012 and the trend may continue. There is considerable uncertainty over the long-term effects of the expansionary monetary and fiscal policies adopted by the central banks and financial authorities of some of the world's leading economies, including the United States and China. There have been concerns over unrest and terrorist threats in the Middle East, Europe and Africa, such as wars and conflicts in Ukraine and Russia, which have resulted in market volatility.

If YS Group plans to expand its business internationally and does cross-border business in the future, any unfavorable government policies on international trade, such as capital controls or tariffs, may affect the demand for its products and product candidates, impact its competitive position, or prevent it from being able to conduct business in certain countries. If any new tariffs, legislation, or regulations are implemented, or if existing trade agreements are renegotiated, such changes could adversely affect YS Group's business, financial condition, and results of operations. In particular, there have been heightened tensions in international economic relations between the United States and China. The U.S. government has recently imposed, and has recently proposed to impose additional, new, or higher tariffs on certain products imported from China to penalize China for what the U.S. government characterizes as unfair trade practices. China has responded by imposing, and proposing to impose additional, new, or higher tariffs on certain products imported from the United States. Following mutual retaliatory actions for months, on January 15, 2020, the United States and China entered into the Economic and Trade Agreement Between the United States of America and the PRC as a phase one trade deal, effective on February 14, 2020. Although the direct impact of the current international trade tension, and any escalation of such tension, on the holographic technology industry in China is uncertain, the negative impact on general, economic, political and social conditions may adversely impact YS Group's business, financial condition and results of operations.

YS Group's business operations are subject to various PRC laws and regulations, the interpretation and enforcement of which involve significant uncertainties as the PRC legal system is evolving rapidly.

The PRC legal system is a civil-law system based on written statutes. Unlike the common-law system, prior court decisions under the civil-law system may be cited for reference but have limited precedential value, which has led to uncertainty and inconsistency in the interpretation and enforcement of many laws. Uncertainties also exist with respect to new legislation or proposed changes in the PRC regulatory requirements as the PRC legal system is evolving

rapidly. The interpretations of many laws and regulations may contain inconsistencies, and the enforcement of these laws, regulations and rules involves uncertainties. In addition, laws and regulations can change quickly with limited advance notice. From time to time, YS Group may have to resort to administrative and court proceedings to enforce its legal rights. Because PRC administrative and court authorities have significant discretion in interpreting and implementing statutory provisions and contractual terms, it may be difficult to evaluate the outcome of administrative and court proceedings and the level of legal protection YS Group enjoys. Such uncertainty towards the contractual, property and procedural rights and legal obligations could adversely affect its business and impede its ability to grow their business. In addition, the regulatory uncertainties may be exploited through unmerited or frivolous legal actions or threats in attempts to extract payments or benefits from YS Group.

PRC regulations relating to offshore investment activities by PRC residents may subject YS Biopharma's PRC resident shareholders, beneficial owners and PRC subsidiaries to liability or penalties, limit their ability to inject capital into its PRC subsidiaries, limit its PRC subsidiaries' ability to increase their registered capital or distribute profits to YS Group or otherwise adversely affect it.

In July 2014, the SAFE promulgated the Circular on Relevant Issues Concerning Foreign Exchange Control on Domestic Residents' Offshore Investment and Financing and Roundtrip Investment Through Special Purpose Vehicles ("SAFE Circular 37"). SAFE Circular 37 requires PRC residents (including PRC individuals and PRC corporate entities, as well as foreign individuals that are deemed PRC residents for foreign exchange administration purposes) to register with the SAFE or its local branches in connection with their direct or indirect offshore investment activities. SAFE Circular 37 further requires the SAFE registrations be updated in the event of any changes with respect to the basic information of the offshore special purpose vehicle, such as a change in its name, operation term and PRC resident shareholder, an increase or decrease of capital contribution, share transfer or exchange by PRC resident individuals, or mergers or divisions.

In September 2014, MOFCOM promulgated the Measures for the Administration of Overseas Investment. In December 2017, the NDRC further promulgated the Administrative Measures of Overseas Investment of Enterprises, which became effective in March 2018. Pursuant to these regulations, any outbound investment of PRC enterprises in a non-sensitive area or industry is required to be filed with MOFCOM and the NDRC or their local branches.

YS Biopharma requested that all of its current shareholders and beneficial owners who, to their and YS Biopharma's knowledge, are PRC residents complete the foreign exchange registrations and that those who, to their and YS Biopharma's knowledge, are PRC enterprises comply with outbound investment related regulations. However, YS Biopharma may not be informed of the identities of all the PRC residents and PRC enterprises holding direct or indirect interest in YS Biopharma, and they and YS Biopharma cannot provide any assurance that these PRC residents and PRC enterprises will comply with their and YS Biopharma's request to make or obtain the applicable registrations or continuously comply with all the requirements under SAFE Circular 37 or other related rules and the outbound investment related regulations. Failure by such shareholders or beneficial owners to comply with SAFE and outbound investment related regulations, or failure by YS Biopharma to amend the foreign exchange registrations of its PRC subsidiaries, could subject YS Biopharma to fines or legal sanctions, restrict its overseas or cross-border investment activities, limit YS Biopharma's PRC subsidiaries' ability to make distributions or pay dividends to YS Biopharma or affect its ownership structure, which could adversely affect its business and prospects.

Furthermore, as these foreign exchange and outbound investment related regulations are relatively new and their interpretation and implementation are evolving, it is uncertain how these regulations, and any future regulations concerning offshore or cross-border investments and transactions, will be interpreted, amended and implemented by the relevant government authorities. For example, YS Biopharma may be subject to a more stringent review and approval process with respect to its foreign exchange activities, such as remittance of dividends and foreign-currency-denominated borrowings, which may adversely affect YS Biopharma's financial condition and results of operations. Due to the complexity and constantly changing nature of the regulations related to foreign exchange and outbound investment, as well as the uncertainties involved, YS Biopharma cannot assure you that it has complied or will be able to comply with all applicable foreign exchange and outbound investment related regulations. In addition, if YS Group decides to acquire a PRC domestic company, YS Group cannot assure you that it or the owners of such company, as the case may be, will be able to obtain the necessary approvals or complete the necessary filings and registrations required by the foreign exchange regulations. This may restrict YS Biopharma's ability to implement YS Group's acquisition strategy and could adversely affect its business and prospects.

YS Group's PRC subsidiaries are subject to restrictions on paying dividends or making other payments to its offshore holding companies, including YS Biopharma, which may restrict their ability to satisfy liquidity requirements.

YS Biopharma is a holding company incorporated in the Cayman Islands. Payment of dividends by YS Group's PRC subsidiaries is an important source of support for YS Biopharma to meet their financing needs, and such payment is subject to various restrictions. Current PRC regulations permit the PRC subsidiaries to pay dividends to their offshore holding companies only out of their accumulated after-tax profits upon satisfaction of relevant statutory condition and procedures, if any, determined in accordance with Chinese accounting standards and regulations. In addition, each of YS Group's PRC subsidiaries is required to set aside at least 10% of its after-tax profits each year, if any, to fund certain reserve funds until the total amount set aside reaches 50% of its registered capital. In addition, the PRC Enterprise Income Tax Law and its implementation rules provide that withholding tax at the rate of 10% will be applicable to dividends payable by Chinese companies to non-PRC-resident enterprises, unless otherwise exempted or reduced according to treaties or arrangements between the PRC central government and governments of other countries or regions where the non-PRC-resident enterprises are incorporated. Furthermore, if YS Group's PRC subsidiaries incur debt on their own behalf in the future, the instruments governing the debt may restrict their ability to pay dividends or make other payments to YS Group which may restrict their offshore holding companies' ability to satisfy YS Group's liquidity requirements.

Fluctuations in exchange rates could have a material and adverse effect on the value of your investment and YS Biopharma's results of operations.

The value of the Renminbi against the U.S. dollar and other currencies may fluctuate and is affected by, among other things, changes in the political and economic conditions in China and China's foreign exchange policies. On July 21, 2005, the PRC government changed its decade-old policy of pegging the value of the Renminbi to the U.S. dollar. On November 30, 2015, the Executive Board of the International Monetary Fund completed the regular five-year review of the basket of currencies that make up the Special Drawing Right (the "SDR") and decided that, from October 1, 2016, Renminbi would be determined to be a freely usable currency and will be included in the SDR basket. Since June 2010, the Renminbi has fluctuated significantly against the U.S. dollar. It is difficult to predict how market forces or policies by the PRC or U.S. government may impact the exchange rate between the Renminbi and the U.S. dollar in the future. With the development of the foreign exchange market and progress towards interest rate liberalization and Renminbi internationalization, the PRC government may in the future announce further changes to the exchange rate system, and YS Group cannot assure you that the Renminbi will not appreciate or depreciate significantly in value against the U.S. dollar in the future.

Significant revaluation of the Renminbi may materially and adversely affect the revenues, earnings and financial position of YS Group, and the value and trading price of, and any dividends payable on, YS Biopharma's securities in U.S. dollars. The appreciation of the Renminbi against the U.S. dollar would have an adverse effect on the Renminbi amount that would be received from the conversion to the extent that needs to be converted U.S. dollars into Renminbi for capital expenditures and working capital and other business purposes. Conversely, a significant depreciation of the Renminbi against the U.S. dollar may significantly reduce the U.S. dollar equivalent of the earnings, which in turn could adversely affect the price of YS Biopharma's securities and have a negative effect on the U.S. dollar amount available to YS Group for the purpose of making payments for dividends on YS Biopharma's securities, royalties, strategic acquisitions or investments or for other business purposes.

Very limited hedging options are available in China to reduce YS Group's exposure to exchange rate fluctuations. To date, no hedging transactions in an effort to reduce the exposure of YS Group or YS Biopharma to foreign currency exchange risk were contracted. While YS Group may enter into hedging transactions in the future, the availability and effectiveness of these transactions may be limited, and YS Group may not be able to adequately hedge the exposure, or at all. In addition, YS Group's currency exchange losses may be magnified by PRC exchange control regulations that restrict its ability to convert Renminbi into foreign currency.

PRC regulation of loans to and direct investment in PRC entities by offshore holding companies and governmental control of currency conversion may restrict or delay YS Biopharma from using the offshore proceeds to make loans or additional capital contributions to its PRC subsidiaries, which could adversely affect its liquidity and ability to fund and expand its business.

Under PRC laws and regulations, loans by YS Biopharma to its PRC subsidiaries to finance their operations shall not exceed certain statutory limits and must be registered with the local counterpart of the SAFE, and any capital contribution from YS Biopharma or YS Biopharma to its PRC subsidiaries is required to be registered, filed with or

reported to the competent PRC governmental authorities. Currently, there is no statutory limit to the amount of funding that it can provide to YS Group's PRC subsidiaries through capital contributions, because there is no statutory limit on the amount of registered capital for its PRC subsidiaries and it is allowed to make capital contributions to its PRC subsidiaries by subscribing for their registered capital, provided that the PRC subsidiaries complete the relevant filing, registration and reporting procedures. According to relevant PRC regulations on foreign-invested enterprises, capital contributions to the relevant PRC subsidiaries are required to be registered with the SAMR or its local counterpart and a local bank authorized by SAFE, and reported to MOFCOM's local counterpart.

Foreign exchange controls may limit YS Group's ability to effectively utilize its revenues and proceeds generated or financed outside China and adversely affect the value of your investment.

The PRC government imposes foreign exchange controls on the convertibility of the Renminbi and, in certain cases, the remittance of currency out of China. YS Group receives substantially all of its revenues in Renminbi. Under the corporate structure following the Business Combination, YS Biopharma, which is YS Group's Cayman Islands holding company primarily relies on dividend payments from its PRC subsidiaries to fund any cash and financing requirements it may have. Under the existing exchange restrictions, without prior approval of the SAFE, cash generated from the operations of PRC subsidiaries in China may be used to pay dividends to YS Biopharma. However, approval from or registration with appropriate government authorities is required where Renminbi is to be converted into foreign currency and remitted out of mainland China to pay capital expenses, such as the repayment of loans denominated in foreign currencies. As a result, YS Biopharma needs to obtain requisite approval or registration to use cash generated from the operations of its PRC subsidiaries to pay off their respective debt in a currency other than Renminbi owed to entities outside China, or to make other capital expenditure payments outside China in a currency other than Renminbi. The PRC government may also at its discretion restrict access to foreign currencies for current account transactions in the future. If the foreign exchange control system prevents YS Group from obtaining sufficient foreign currencies to satisfy its foreign currency demands, YS Biopharma may not be able to pay dividends to you or fulfill other payment obligations in foreign currencies or fund any future operations that it may have outside of mainland China with foreign currencies.

In addition, under the Circular on Reforming the Management Approach Regarding the Foreign Exchange Capital Settlement of Foreign-Invested Enterprises ("FIEs") and the Notice of the State Administration of Foreign Exchange on Reforming and Standardizing the Foreign Exchange Settlement Management Policy of Capital Account, FIEs are prohibited from using Renminbi funds converted from their foreign exchange capital for expenditures beyond their business scopes or using such Renminbi funds to provide loans to persons other than their affiliates, unless within their business scope.

Any foreign loan procured by YS Group's PRC subsidiaries is also required to be registered with the SAFE or its local branches or be filed with the SAFE in its information system, and each of YS Group's PRC subsidiaries may not procure loans which exceed either (1) the amount of the difference between their respective registered total investment amount and registered capital or (2) two and a half times, or the then-applicable statutory multiple, the amount of their respective audited net assets, calculated in accordance with PRC GAAP (the "Net Assets Limit"), at YS Group's election. Increasing the amount of the difference between their respective registered total investment amount and registered capital of the PRC subsidiaries might be subject to governmental approval and may require a PRC subsidiary to increase its registered capital at the same time. If YS Group makes a loan to a PRC entity based on its Net Assets Limit, the maximum amount that the offshore companies would be able to loan to the relevant PRC entity would depend on the relevant entity's net assets and the applicable statutory multiple at the time of the calculation. As of the date of this prospectus, all of YS Group's PRC subsidiaries have negative or very limited net assets, which prevents them from providing loans to them using the Net Assets Limit. Any medium- or long-term loan to be provided by YS Group or a foreign third party to the PRC subsidiaries must also be registered by and filed with the NDRC.

On October 23, 2019, SAFE further issued the Circular of the State Administration of Foreign Exchange on Further Promoting the Facilitation of Cross-Border Trade and Investment ("Circular 28"), which took effect on the same day and was revised on December 4, 2023. Circular 28 allows non-investment FIEs to use their capital funds to make equity investments in China as long as such investments do not violate the then effective negative list for foreign investments and the target investment projects are genuine and in compliance with laws. In addition, Circular 28 stipulates that qualified enterprises in certain pilot areas may use their capital income from registered capital, foreign debt and overseas listing, for the purpose of domestic payments without providing authenticity certifications to the relevant banks in advance for those domestic payments. As this circular is relatively new, there remains uncertainty as to its interpretation and application and any other future foreign exchange-related rules. Violations of these circulars could result in severe monetary or other penalties.

[Table of Contents](#)

These PRC laws and regulations may significantly limit YS Biopharma's ability to use Renminbi converted from the proceeds received outside China to fund the establishment of new entities in China by its PRC subsidiaries, and to invest in or acquire any other PRC companies through its PRC subsidiaries. Moreover, YS Group cannot assure you that it will be able to complete the necessary registrations or obtain the necessary government approvals on a timely basis, if at all, with respect to future loans to its PRC subsidiaries, or future capital contributions by YS Group to its PRC subsidiaries. If it fails to complete such registrations or obtain such approvals or if it is found to be in violation of any applicable laws with respect to foreign currency exchange, its ability to use the proceeds it received or expect to receive from YS Group's offshore offerings may be negatively affected and it may be subject to penalties, which could materially and adversely affect its liquidity and its ability to fund and expand its business.

The M&A Rules and certain other PRC regulations could make it more difficult for YS Group to pursue growth through acquisitions in China.

In China, the M&A Rules, established additional procedures and requirements that could make merger and acquisition activities involving the PRC by foreign investors more time-consuming and complex, including requirements in some instances that the in-charge government authority be notified and relevant approval shall be obtained in advance of any change-of-control transaction in which a foreign investor takes control of a PRC domestic enterprise. Moreover, the Anti-monopoly Law of the PRC requires that the in-charge government authority be notified in advance of any concentration of undertaking if certain thresholds are triggered. In light of the uncertainties relating to the interpretation, implementation and enforcement of the Anti-monopoly Law, YS Group cannot assure you that the in-charge Anti-monopoly Law enforcement agency will not deem YS Group's past acquisition or investments to have triggered the filing requirement for anti-trust review. If YS Group is found to have violated the Anti-monopoly Law for failing to file the notification of concentration and request for review, it could be, among others, subject to a fine of up to RMB5,000,000 if the concentration has no effect of eliminating the restricting competition, or a fine of not more than 10% of its sales amount in the previous year if the concentration has or may have the effect of eliminating or restricting competition, and the parts of the transaction causing the prohibited concentration could be ordered to be unwound, which may materially and adversely affect its business, financial condition and results of operations. In addition, under applicable laws, mergers and acquisitions by foreign investors that raise "national defense and security" concerns and mergers and acquisitions through which foreign investors may acquire de facto control over domestic enterprises that raise "national security" concerns are subject to strict review by MOFCOM, and any activities attempting to bypass a security review, including by structuring the transaction through a proxy or contractual control arrangement, are prohibited.

In the future, YS Group or YS Biopharma may grow its business by acquiring complementary businesses. Complying with the requirements of the above-mentioned regulations and other relevant rules to complete such transactions could be time-consuming, and any required approval processes, including obtaining approval from MOFCOM or its local counterparts, may delay or inhibit its ability to complete such transactions, which could affect its ability to expand its business or maintain YS Group's market share.

Failure to comply with PRC regulations regarding the registration requirements for employee stock ownership plans or share option plans may subject the PRC plan participants or YS Biopharma to fines and other legal or administrative sanctions.

YS Biopharma has assumed the share incentive plan of YS Group and the outstanding awards. Pursuant to the Notice on Issues Concerning the Foreign Exchange Administration for Domestic Individuals Participating in Stock Incentive Plan of Overseas Publicly Listed Company, promulgated by the SAFE in 2012, grantees of YS Biopharma's incentive share awards who are PRC citizens or who are non-PRC residents continuously residing in the PRC for a continuous period of no less than a year (excluding the foreign diplomatic personnel and representatives of international organizations) are required to register with the SAFE and complete certain other procedures through a domestic qualified agent and collectively retain an overseas entrusted institution to handle matters related to the exercise of stock options and the purchase and disposition of related equity interests after YS Biopharma has become an overseas listed company. Failure to comply with these SAFE requirements may subject these individuals to fines and legal sanctions and may also limit the ability of YS Biopharma to contribute additional capital into its PRC subsidiaries and limit its PRC subsidiaries' ability to distribute dividends to YS Biopharma.

The SAT has also issued certain circulars concerning equity incentive awards. Under these circulars, YS Group's employees in China who exercise share options or are granted restricted share units will be subject to PRC individual income tax. If YS Group's employees fail to pay or if YS Group fails to withhold their income taxes according to relevant laws and regulations, YS Group may face sanctions imposed by the tax or other PRC governmental authorities.

Your ability to effect service of legal process, enforce judgments or bring actions against YS Biopharma or certain of their officers and directors outside the U.S. will be limited and additional costs may be required.

YS Biopharma is a Cayman Islands holding company that conducts its substantial operations outside the United States. A majority of YS Biopharma's officers and a minority of YS Biopharma's directors reside outside the United States, and a substantial portion of the assets of those persons are located outside of the United States. For example, certain YS Biopharma's directors and officers reside in mainland China and one independent director resides in Hong Kong. Therefore, it may be difficult or costly for you to effect service of process against YS Biopharma or its officers and directors within the U.S. In addition, as advised by YS Biopharma's PRC legal counsel, it is uncertain (1) whether and on what basis a PRC court would enforce judgment rendered by a court in the U.S. based upon the civil liability provisions of U.S. federal securities laws; and (2) whether an investor will be able to bring an original action in a PRC court based on U.S. federal securities laws. China does not have treaties providing for the reciprocal recognition and enforcement of judgments of courts with the Cayman Islands and many other countries and regions. As such, you may not be able to or may experience difficulties or incur additional costs to enforce judgments obtained in U.S. courts based upon the civil liability provisions of U.S. federal securities laws in China or bring original actions in China based on U.S. federal securities laws even if you are successful in bringing an action of this kind. Furthermore, any judgment obtained in the U.S. against YS Group and these individuals may not be collectible within the United States.

You may face difficulties in protecting your interests, and your ability to protect your rights through U.S. courts may be limited, because YS Biopharma is incorporated under the law of the Cayman Islands, YS Biopharma conducts substantially all of its operations and a majority of their respective directors and executive officers reside outside of the United States.

YS Biopharma is an exempted company limited by shares incorporated under the laws of the Cayman Islands, and YS Biopharma will continue to conduct a majority of its operations through its subsidiaries, namely Philippines Yisheng, Singapore Yisheng, Liaoning Yisheng and Beijing Yisheng, outside the United States. Substantially all of YS Biopharma's assets are located outside of the United States. A majority of YS Biopharma's officers and a minority of YS Biopharma's directors reside outside the United States and a substantial portion of the assets of those persons are located outside of the United States, including, among others, certain YS Biopharma's directors and officers reside in mainland China and one independent director of YS Biopharma resides in Hong Kong. As a result, it could be difficult or impossible for you to bring an action against YS Biopharma or against these individuals outside of the United States in the event that you believe that your rights have been infringed upon under the applicable securities laws or otherwise. Even if you are successful in bringing an action of this kind, the laws of the Cayman Islands and of the PRC could render you unable to enforce a judgment against the relevant assets or the assets of the relevant directors and officers.

In addition, YS Biopharma's corporate affairs are governed by the Amended YS Biopharma Articles, the Cayman Islands Companies Act and the common law of the Cayman Islands. The rights of investors to take action against the directors, actions by minority shareholders and the fiduciary duties of YS Biopharma's directors to YS Biopharma under Cayman Islands law are to a large extent governed by the common law of the Cayman Islands. The common law of the Cayman Islands is derived in part from comparatively limited judicial precedent in the Cayman Islands as well as from the common law of England, the decisions of whose courts are of persuasive authority, but are not binding, on a court in the Cayman Islands. The rights of YS Biopharma's shareholders and the fiduciary duties of YS Biopharma's directors under Cayman Islands law may not be as clearly established as they would be under statutes or judicial precedent in some jurisdictions in the United States. In particular, the Cayman Islands has a different body of securities laws than the United States. Some U.S. states, such as Delaware, may have more fully developed and judicially interpreted bodies of corporate law than the Cayman Islands. In addition, Cayman Islands companies may not have a standing to initiate a shareholder derivative action in a federal court of the United States.

Shareholders of Cayman Islands exempted companies like YS Biopharma have no general rights under Cayman Islands law to inspect corporate records or to obtain copies of lists of shareholders of these companies (save for the memorandum and articles of association, the register of mortgages and charges, and special resolutions of YS Biopharma's shareholders). YS Biopharma's directors will have discretion under the Amended YS Biopharma Articles to determine whether or not, and under what conditions, YS Biopharma's corporate records may be inspected by its shareholders, but YS Biopharma is not obliged to make them available to the shareholders. This may make it more difficult for you to obtain the information needed to establish any facts necessary for a shareholder's motion or to solicit proxies from other shareholders in connection with a proxy contest. See "Description of YS Biopharma's Securities — Ordinary Shares — Inspection of Books and Records."

[Table of Contents](#)

Certain corporate governance practices in the Cayman Islands, which is YS Biopharma's home country, differ significantly from requirements for companies incorporated in other jurisdictions such as the United States. To the extent that YS Biopharma chooses to follow home country practice with respect to corporate governance matters, its shareholders may be afforded less protection than they otherwise would under rules and regulations applicable to U.S. domestic issuers.

As a result of all of the above, YS Biopharma's shareholders may have more difficulty in protecting their interests in the face of actions taken by management, members of the board of directors or controlling shareholders than they would as public shareholders of a company incorporated in the United States.

Inflation in China and increase in labor costs could negatively affect the profitability and growth of YS Group.

Economic growth in China has been accompanied by periods of high inflation, and the PRC government implemented various policies from time to time to control inflation, including imposing various corrective measures designed to restrict the availability of credit or regulate growth. High inflation in the future may cause the PRC government to once again impose controls on credit and/or price of commodities, or to take other actions, which could inhibit economic activities in China. Any action on the part of the PRC government that seeks to control credit and/or price of commodities may adversely affect the business operations of YS Group, causing negative impact on its profitability and growth.

Moreover, the significant economic growth in China has resulted in a general increase in labor costs and shortage of low-cost labor. Inflation may cause its production cost to continue to increase. If YS Group is unable to pass on the increase in production cost to its customers, it may suffer a decrease in profitability and a loss of customers, and YS Group's results of operations could be materially and adversely affected. In addition, PRC entities are subject to stricter regulatory requirements in entering into labor contracts with their employees and paying various statutory employee benefits, including pensions, housing funds, medical insurance, work-related injury insurance, unemployment insurance and maternity insurance to designated government agencies for the benefit of their employees. Pursuant to the PRC Labor Contract Law and its implementation rules, employers are subject to stricter requirements in signing labor contracts, minimum wages, overtime work, labor dispatch, paying remuneration, determining the term of employee's probation and unilaterally terminating labor contracts. In the event YS Group decides to terminate some of its employees or otherwise change their employment or labor practices, the PRC Labor Contract Law and its implementation rules may limit its ability to effect those changes in a desirable or cost-effective manner, which could adversely affect its business and results of operations. In addition, YS Group needs to apply for flexible working hours arrangement and comprehensive working hours scheme with relevant PRC authorities and comply with the requirements contained in the relevant approvals, or pay employees overtime work compensations in case YS Group intends to ask its employees to work overtime. YS Group might not be able to, in a timely manner or at all, obtain relevant approvals and fully comply with requirements therein, or pay the overtime work compensation according to relevant regulations.

Pursuant to the PRC laws and regulations, companies registered and operating in China are required to apply for social insurance registration and housing fund deposit registration within 30 days of their establishment and to pay different social insurance and housing provident funds for their employees. YS Group engaged third-party human resources agencies to pay social insurance and housing funds for certain employees for their actual needs to participate in local social insurance and housing fund schemes in their place of residency where YS Group did not have subsidiaries. The contributions of social insurance premium and housing provident funds made through third-party accounts may not be recognized as contributions made by YS Group, and as a result, YS Group may be required by competent authorities to pay the outstanding amount, and could be subject to late payment fines and other penalties or enforcement application made to the court. See "— YS Group may be subject to fines and penalties under applicable PRC laws and regulations for failure to make adequate contributions to social insurance and housing provident fund for its employees." Recently, as the PRC government enhanced its enforcement measures relating to social insurance collection, it may be required to make up the contributions for YS Group's employees, and may be further subjected to late fees payment and administrative fines, which may adversely affect its financial condition and results of operations.

As the interpretation and implementation of labor-related laws and regulations are still evolving, YS Group cannot assure you that YS Group's employment practices have been and will be in compliance with labor-related laws and regulations in China in all material respects, which may subject it to labor disputes or government investigations and penalties. In addition, it may incur additional expenses in order to comply with such laws and regulations, which may adversely affect its business and profitability.

YS Biopharma may be deemed to be a PRC tax resident under the EIT Law following the consummation of the Business Combination, and as a result, their global income could be subject to PRC withholding tax and enterprise income tax.

YS Biopharma is a holding company incorporated under the laws of the Cayman Islands and indirectly hold interests in a Hong Kong-incorporated subsidiary, which in turn hold interests in certain PRC subsidiaries following the consummation of the Business Combination. Pursuant to the EIT Law, effective in January 2008, as amended on lately December 29, 2018, and its implementation rules, dividends payable by a foreign-invested enterprise to its foreign corporate investors who are not deemed a PRC resident enterprise are subject to a 10% withholding tax, unless such foreign investor's jurisdiction of incorporation has a tax treaty with the PRC that provides for a different withholding tax arrangement. Under the Arrangement between the Mainland of China and Hong Kong Special Administration Region for the Avoidance of Double Taxation and the Prevention of Fiscal Evasion with Respect to Tax on Income (the "Tax Treaty") which was promulgated by SAT and the Hong Kong government on August 21, 2006, such dividend withholding tax rate is reduced to 5% for dividends paid by a PRC resident enterprise to a Hong Kong-resident enterprise if such Hong Kong entity is a "beneficial owner" and such entity directly owns at least 25% of the equity interest of the PRC company. The Announcement on Issues Relating to "Beneficial Owner" in Tax Treaties, effective in April 2018, provides certain factors for the determination of "beneficial owner" status of a company under the Tax Treaty. If the PRC tax authorities determine that YS Group's Hong Kong subsidiary is not a "beneficial owner," YS Group may not be able to enjoy a preferential withholding tax rate of 5% and dividend payable by its PRC subsidiaries to its Hong Kong subsidiary will be subject to withholding tax at the rate of 10%.

The EIT Law and its implementation rules also provide that if an enterprise incorporated outside China has its "de facto management bodies" within China, such enterprise may be deemed a "PRC resident enterprise" for tax purposes and be subject to an enterprise income tax rate of 25% on its global incomes. "De facto management body" is defined as the body that has the significant and overall management and control over the business, personnel, accounts and properties of an enterprise. In April 2009, SAT promulgated a circular, known as Circular 82, and partially amended by Circular 9 promulgated in January 2014, to clarify the certain criteria for the determination of the "de facto management bodies" for foreign enterprises controlled by PRC enterprises or PRC enterprise groups. Further to Circular 82, the SAT issued a bulletin, known as Bulletin 45, effective in September 2011 and lately amended on June 15, 2018, respectively to provide more guidance on the implementation of Circular 82 and clarify the reporting and filing obligations of such "Chinese-controlled offshore incorporated resident enterprises." Although Circular 82 and Bulletin 45 explicitly provide that the above standards apply to enterprises that are registered outside China and controlled by PRC enterprises or PRC enterprise groups, these regulations may reflect SAT's criteria for determining the tax residence of foreign enterprises in general.

However, there are no official implementation rules regarding the determination of the "de facto management bodies" for foreign enterprises not controlled by PRC enterprises (including companies like YS Biopharma). Therefore, it remains unclear how the tax authorities will treat a case such as YS Biopharma and its subsidiaries following the consummation of the Business Combination. However, if the PRC authorities were to subsequently determine, or any future regulation provides, that it should be treated as a PRC resident enterprise, it will be subject to the uniform 25% enterprise income tax on its global incomes. In addition, although the EIT Law provides that dividend payments between qualified PRC-resident enterprises are exempt from enterprise income tax, there is uncertainty to the detailed qualification requirements for this exemption and whether dividend payments by PRC subsidiaries of YS Biopharma to YS Biopharma will meet such qualification requirements even if it is considered a PRC resident enterprise for tax purposes.

There remains significant uncertainty as to the interpretation and application of applicable PRC tax laws and rules by the PRC tax authorities, and the PRC tax laws, rules and regulations may also change. If there is any change to applicable tax laws and rules and interpretation or application with respect to such laws and rules, the value of your investment in YS Group's shares may be materially affected.

YS Group and YS Biopharma's Shareholders face uncertainties with respect to the Business Combination and other indirect transfers of equity interests in PRC resident enterprises.

Under the SAT Bulletin 7, an "indirect transfer" of assets, including equity interests in a PRC resident enterprise, by non-PRC resident enterprises may be re-characterized and treated as a direct transfer of PRC taxable assets, if such arrangement does not have a reasonable commercial purpose and was established for the purpose of reducing,

deferring or avoiding payment of PRC enterprise income tax. As a result, gains derived from such indirect transfer may be subject to PRC enterprise income tax. According to SAT Bulletin 7, “PRC taxable assets” include assets attributed to an establishment in China, immovable properties in China, and equity investments in PRC resident enterprises. In respect of an indirect offshore transfer of assets of a PRC establishment, the relevant gain is to be regarded as effectively connected with the PRC establishment and therefore included in its enterprise income tax filing, and would consequently be subject to PRC enterprise income tax at a rate of 25%. Where the underlying transfer relates to the immovable properties in China or to equity investments in a PRC resident enterprise, which is not effectively connected to a PRC establishment of a non-resident enterprise or otherwise provided in the SAT Bulletin 7, a PRC enterprise income tax of 10% would apply, subject to available preferential tax treatment under applicable tax treaties or similar arrangements, and the party who is obligated to make the transfer payments has the withholding obligation. There is uncertainty as to the implementation details of SSAT Bulletin 7. If SAT Bulletin 7 was determined by the tax authorities to be applicable to some of YS Group’s transactions involving PRC taxable assets, including the Business Combination, the offshore subsidiaries of YS Group and YS Biopharma conducting the relevant transactions might be required to spend valuable resources to comply with SAT Bulletin 7 or to establish that the relevant transactions should not be taxed under SAT Bulletin 7.

On October 17, 2017, the SAT issued the Bulletin on Issues Concerning the Source-based Withholding of Enterprise Income Tax on Non-resident Enterprises, or Bulletin 37, which became effective on December 1, 2017. According to Bulletin 37, if the withholding agent fails to or is unable to withhold the income tax in accordance with the law, the tax authority may order the payment within a time limit, and non-resident enterprises shall declare and make the payment within such time limit required by the tax authority, and the non-resident enterprise will be deemed to have cleared its tax payment on time if it voluntarily declares and pays the tax before or within the time limit the tax authority orders it to do so. If the taxable income before withholding on a source-basis falls within the form of dividends or any equity investment gains, the date of triggering obligations to settle such tax payments is the date of actual payment of the dividends or other equity investment gains. In addition, on December 1, 2017, Bulletin 37 repealed the Notice of the SAT on Strengthening the Administration over Enterprise Income Tax on Income of Non-resident Enterprises from Equity Transfer and Notice of the SAT on Issuing the Interim Measures for the Administration of Source-based Withholding of the Enterprise Income Tax of Non-resident Enterprises issued by the SAT on December 10, 2009 and January 1, 2009, respectively.

As a result, SAT Bulletin 7 could apply if the Business Combination did not have a reasonable business purpose and was carried out to evade PRC corporate income tax obligations. Although YS Biopharma believes SAT Bulletin 7 does not apply to the Business Combination, it is possible that PRC tax authorities would make an assessment that the Business Combination is subject to SAT Bulletin 7. If SAT Bulletin 7 were to apply to the Business Combination, there would be PRC 10% withholding tax imposed on any gain deemed, from a PRC tax perspective, to have been realized from the Business Combination. In addition, YS Group, YS Biopharma and their respective non-PRC Shareholders may have the risk of being taxed for the disposition of YS Group’s Shares and may be required to spend valuable resources to comply with SAT Bulletin 7 and SAT Bulletin 37 or to establish that YS Group, YS Biopharma and their respective non-PRC Shareholders should not be taxed as an indirect transfer, which may have a material adverse effect on their results of operations and financial condition or the investment by non-PRC investors in YS Biopharma’s securities.

In addition, since YS Biopharma may pursue acquisitions, and may conduct acquisitions involving complex corporate structures, the PRC tax authorities may, at their discretion, adjust the capital gains or request that it submit additional documentation for their review in connection with any potential acquisitions, which may cause it to incur additional acquisition costs or delay YS Group’s acquisition timetable.

Dividends payable to YS Biopharma’s foreign investors and gains on the sale of YS Biopharma’s securities by foreign investors may become subject to PRC tax.

Under the EIT Law and its implementation regulations issued by the State Council, a 10% PRC withholding tax is applicable to dividends payable to investors that are non-resident enterprises, which do not have an establishment or place of business in China or which have such establishment or place of business but the dividends are not effectively connected with such establishment or place of business, to the extent such dividends are derived from sources within China. Similarly, any gain realized on the transfer of the ADSs by such investors is also subject to a PRC tax rate of 10%, subject to any reduction or exemption set forth in applicable tax treaties or under applicable tax arrangements between jurisdictions, if such gain is regarded as income derived from sources within China. If YS Biopharma is

deemed a PRC resident enterprise, dividends paid on YS Biopharma's securities, and any gain realized from the transfer of YS Biopharma's securities, would be treated as income derived from sources within China and would as a result be subject to PRC taxation. Furthermore, if YS Biopharma is deemed a PRC resident enterprise, dividends payable to individual investors who are non-PRC residents and any gain realized on the transfer of YS Biopharma's securities by such investors may be subject to a PRC tax rate of 20%, subject to any reduction or exemption set forth in applicable tax treaties or under applicable tax arrangements between jurisdictions. If YS Biopharma or any of its subsidiaries established outside China are considered a PRC resident enterprise, it is unclear whether holders of the ADSs would be able to claim the benefit of income tax treaties or agreements entered into between China and other countries or areas. If dividends payable to its non-PRC investors, or gains from the transfer of YS Biopharma's securities by such investors, are deemed as income derived from sources within China and thus are subject to PRC tax, the value of your investment in YS Biopharma's securities may decline significantly.

YS Biopharma faces regulatory uncertainties in China that could restrict its ability to grant share incentive awards to its employees or consultants who are PRC citizens.

Pursuant to the Notices on Issues concerning the Foreign Exchange Administration for Domestic Individuals Participating in a Stock Incentive Plan of an Overseas Publicly-Listed Company issued by SAFE on February 15, 2012, or Circular 7, a qualified PRC agent (which could be the PRC subsidiary of the overseas-listed company) is required to file, on behalf of "domestic individuals" (both PRC residents and non-PRC residents who reside in China for a continuous period of not less than one year, excluding the foreign diplomatic personnel and representatives of international organizations) who are granted shares or share options by the overseas-listed company according to its share incentive plan, an application with SAFE to conduct SAFE registration with respect to such share incentive plan, and obtain approval for an annual allowance with respect to the purchase of foreign exchange in connection with the share purchase or share option exercise. Such PRC individuals' foreign exchange income received from the sale of shares and dividends distributed by the overseas listed company and any other income shall be fully remitted into a collective foreign currency account in China, which is opened and managed by the PRC domestic agent before distribution to such individuals. In addition, such domestic individuals must also retain an overseas entrusted institution to handle matters in connection with their exercise of share options and their purchase and sale of shares. The PRC domestic agent also needs to update registration with SAFE within three months after, among others, the overseas-listed company materially changes its share incentive plan, including making any new share incentive plans.

YS Biopharma has adopted a share incentive plan to assume the outstanding share incentive awards granted by YS Group and may grant options in the future. As such, YS Biopharma, from time to time, needs to apply for or update YS Group's registration with SAFE or its local branches on behalf of its PRC domestic employees or consultants who receive options or other equity-based incentive grants under its share incentive plan or material changes in its share incentive plan. However, it may not always be able to make applications or update its registration on behalf of its PRC domestic employees or consultants who hold any type of share incentive awards in compliance with Circular 7, nor can it ensure you that such applications or update of registration will be successful. If YS Biopharma or the participants of its share incentive plan who are PRC domestic individuals fail to comply with Circular 7, YS Biopharma and/or such participants of its share incentive plan may be subject to fines and legal sanctions, there may be additional restrictions on the ability of such participants to exercise their share options or remit proceeds gained from sale of their shares into China, and YS Biopharma may be prevented from further granting share incentive awards under its share incentive plan to its employees or consultants who are PRC domestic individuals.

It may be difficult for overseas regulators to conduct investigation or collect evidence within China.

Shareholder claims or regulatory investigation that are common in the United States generally are difficult to pursue as a matter of law or practicality in China. For example, in China, there are significant legal and other obstacles to providing information needed for regulatory investigations or litigations initiated outside China.

Although the authorities in China may establish a regulatory cooperation mechanism with the securities regulatory authorities of another country or region to implement cross-border supervision and administration, such cooperation with the securities regulatory authorities in the United States may not be efficient in the absence of mutual and practical cooperation mechanism. Furthermore, according to Article 177 of the PRC Securities Law, which became effective in March 2020, no overseas securities regulator is allowed to directly conduct investigation or evidence collection activities within the PRC territory. While detailed interpretation of or implementation rules under Article 177 have yet to be promulgated, the inability for an overseas securities regulator to directly conduct investigation or evidence

collection activities within China may further increase the difficulties you face in protecting your interests. See also “— Your ability to effect service of legal process, enforce judgments or bring actions against, YS Biopharma or certain of their officers and directors outside the U.S. will be limited and additional costs may be required.”

If the custodians or authorized users of YS Group’s controlling non-tangible assets, including chops and seals, fail to fulfill their responsibilities, or misappropriate or misuse these assets, its business and operations may be materially and adversely affected.

Under PRC law, legal documents for corporate transactions, including agreements and contracts such as the leases and sales contracts that YS Group’s business relies on, are executed using the chop or seal of the signing entity or with the signature of a legal representative whose designation is registered and filed with the relevant local branch of the market supervision administration.

To maintain the physical security of its chops and the chops of its PRC entities, YS Group generally stores them in secured locations accessible only by the authorized personnel of each of its PRC subsidiaries. Although YS Group monitors such authorized personnel, there is no assurance such procedures will prevent all instances of abuse or negligence. Accordingly, if any of YS Group’s authorized personnel misuse or misappropriate its corporate chops or seals, YS Group could encounter difficulties in maintaining control over the relevant entities and experience significant disruption to its operations. If a designated legal representative obtains control of the chops in an effort to obtain control over any of its PRC subsidiaries, YS Group would need to pass a new shareholder or board resolution to designate a new legal representative and it would need to take legal action to seek the return of the chops, apply for new chops with the relevant authorities, or otherwise seek legal redress for the violation of the representative’s fiduciary duties to it, which could involve significant time and resources and divert management attention away from its regular business. In addition, the affected entity may not be able to recover corporate assets that are sold or transferred out of YS Group’s control in the event of such a misappropriation if a transferee relies on the apparent authority of the representative and acts in good faith.

YS Biopharma’s Hong Kong subsidiary or any future operations in Hong Kong or Macau could become subject to more influence and/or control of the PRC government if the Hong Kong or Macau legal system becomes more integrated into the PRC legal system.

Most national laws and regulations of the PRC are not directly applicable in Hong Kong or Macau, except for those listed in the Basic Law of the Hong Kong Special Administrative Region of the PRC or the Basic Law of the Macau Special Administrative Region of the PRC (the “Basic Laws”). However, such list of national laws and regulations that are applicable in Hong Kong or Macau can be expanded by amendment to the Basic Laws. There is no assurance that the Basic Laws will not be further amended to apply more PRC laws and regulations in Hong Kong, or that the PRC and/or Hong Kong or Macau government will not take other actions to promote the further integration of Hong Kong or Macau legal system into the PRC legal system. Although YS Group does not have substantive business operations in Hong Kong and Macau and do not currently expect to have any substantive operations in these regions in the foreseeable future, YS Group cannot assure you that YS Biopharma’s Hong Kong subsidiary or any future operations in Hong Kong or Macau will not be subject to more influence and/or control of the PRC government or even direct oversight or intervention from them if the Hong Kong or Macau legal system becomes more integrated into the PRC legal system, or if the regulators in Hong Kong or Macau adopt similar rules or policies through affirmative legislation or rulemaking within the scope of the authority conferred by the Basic Laws. As a result, YS Group cannot assure you that YS Biopharma’s Hong Kong subsidiary or any future operations in Hong Kong or Macau will not be exposed to the similar regulatory and/or policy risks and uncertainties faced by YS Biopharma’s subsidiaries in China in the future.

Risks Related to Ownership of the Ordinary Shares

The price of the Ordinary Shares may be volatile, and the value of the Ordinary Shares may continue to decline.

YS Biopharma cannot predict the prices at which the Ordinary Shares will trade. The price of the Ordinary Shares may not bear any relationship to the market price at which the Ordinary Shares trade or to any other established criteria of the value of YS Group’s business and prospects, and the market price of the Ordinary Shares may fluctuate substantially. In addition, the trading price of the Ordinary Shares is likely to be volatile and could be subject to fluctuations in response

[Table of Contents](#)

to various factors, some of which are beyond YS Biopharma's control. These fluctuations could cause you to lose all or part of your investment in the Ordinary Shares as you might be unable to sell your shares at or above the price you paid. Factors that could cause fluctuations in the trading price of the Ordinary Shares include the following:

- actual or anticipated fluctuations in YS Group's financial condition or results of operations;
- variance in YS Group's financial performance from expectations of securities analysts;
- changes in the pricing of YS Group's products;
- changes in YS Group's projected operating and financial results;
- changes in laws or regulations applicable to YS Group's products and industry;
- announcements by YS Group or its competitors of significant business developments, acquisitions, strategic partnerships or new offerings;
- sales of the Ordinary Shares by YS Biopharma or its shareholders as well as the exercise of options;
- significant product recalls, regulatory investigations, disruptions to or other incidents involving YS Biopharma's products;
- YS Biopharma's involvement in litigation;
- conditions, advancements, breakthroughs or developments affecting the vaccine industries;
- future sales of the Ordinary Shares by YS Biopharma or its shareholders, as well as the anticipation of lock-up releases;
- changes in senior management or key personnel;
- the trading volume of the Ordinary Shares;
- changes in the anticipated future size and growth rate of YS Group's markets;
- changes in market sentiment towards the healthcare or biopharmaceutical sector, or shifts in investment trends;
- publication of research reports or news stories about YS Group, its competitors or its industry, or positive or negative recommendations or withdrawal of research coverage by securities analysts;
- Changes in general economic, political, regulatory and market conditions; and
- other events or factors, including those resulting from wars including the conflict between Russia and Ukraine, incidents of terrorism, global pandemics or responses to these events.

Any of these factors may result in large and sudden changes in the volume and price at which the Ordinary Shares will trade. The securities of some China-based companies listed in the United States have experienced significant volatility since their initial public offerings, including, in some cases, substantial declines in the trading prices of their securities. The trading performances of these companies' securities after their offerings may affect the attitudes of investors towards Chinese companies listed in the United States in general, which consequently may impact the trading performance of the Ordinary Shares, regardless of YS Group's actual operating performance. In addition, any negative news or perceptions about inadequate corporate governance practices or fraudulent accounting, corporate structure or other matters of other Chinese companies may also negatively affect the attitudes of investors towards Chinese companies in general, including YS Group, regardless of whether YS Group has engaged in any inappropriate activities. In particular, the global financial crisis, the ensuing economic recessions and deterioration in the credit market in many countries have contributed and may continue to contribute to extreme volatility in the global stock markets.

Moreover, there have been recent instances of extreme stock price run-ups followed by rapid price declines and strong stock price volatility with a number of recent initial public offerings, particularly among companies with relatively smaller public floats. As YS Biopharma has a relatively small public float after the completion of this offering,

[Table of Contents](#)

YS Biopharma may experience greater stock price volatility, including aggressive price run-ups and declines, lower trading volume and less liquidity, compared with companies with larger public floats. In particular, the Ordinary Shares may be subject to rapid and substantial price volatility, low volumes of trades and large spreads in bid and ask prices. Such volatility, including any stock run-up, may be unrelated to YS Group's actual or expected operating performance, financial condition or prospects, and industry, market or economic factors, which makes it difficult for prospective investors to assess such rapidly changing value of the Ordinary Shares. In addition, if the trading volumes of the Ordinary Shares are low, persons buying or selling in relatively small quantities may easily influence prices of the Ordinary Shares. This low volume of trades could also cause the price of the Ordinary Shares to fluctuate significantly, with large percentage changes in price occurring in any trading day session. Holders of the Ordinary Shares may also not be able to readily liquidate their investment or may be forced to sell at depressed prices due to such low-volume trading. As a result of such volatility, investors may experience losses on their investment in the Ordinary Shares. Such volatility also could adversely affect YS Biopharma's ability to issue additional Ordinary Shares or other securities and YS Biopharma's ability to obtain additional financing in the future, as well as YS Biopharma's ability to retain key employees, many of whom have been granted equity incentives. Furthermore, the extreme volatility may confuse the public investors of the value of the Ordinary Shares, distort the market perception of the price of the Ordinary Shares, and YS Group's financial performance and public image, and negatively affect the long-term liquidity of the Ordinary Shares, regardless of YS Group's actual or expected operating performance.

In the past, shareholders of public companies have brought securities class action suits against companies following periods of instability in the market price of their securities. If YS Biopharma were involved in a class action suit, it could divert a significant amount of the attention of YS Group's management and other resources from YS Group's business and require YS Group to incur significant expenses to defend the suit, which could harm its results of operations. Any such class action suit, whether or not successful, could harm YS Group's reputation and restrict its ability to raise capital in the future. Furthermore, the announcement or perception of such litigation could potentially harm YS Group's reputation and the market price of its ordinary shares. If a claim is successfully made against it, YS Biopharma may be required to pay significant damages or settlements if YS Group does not have enough insurance coverage to satisfy such judgments or settlements, which could have a material adverse effect on YS Group's results of operations and financial condition.

A market for YS Biopharma's securities may not develop or be sustained, which would adversely affect the liquidity and price of its securities.

Following the Business Combination, the price of YS Biopharma's securities fluctuated significantly due to the market's reaction to the Business Combination and general market and economic conditions. An active trading market for YS Biopharma's securities following the Business Combination may never develop or, if developed, it may not be sustained. In addition, the price of YS Biopharma's securities after the Business Combination can vary due to general economic conditions and forecasts, its general business condition and the release of its financial reports. Additionally, if YS Biopharma's securities become delisted from the Nasdaq Stock Market LLC and are quoted on the OTC Bulletin Board (an inter-dealer automated quotation system for equity securities that is not a national securities exchange) or the combined company's securities are not listed on the Nasdaq Stock Market LLC and are quoted on the OTC Bulletin Board, the liquidity and price of YS Biopharma's securities may be more limited than if YS Biopharma were quoted or listed on Nasdaq, NYSE or another national securities exchange. You may be unable to sell your securities unless a market can be established or sustained.

Provisions in the Amended YS Biopharma Articles could discourage, delay or prevent a change of control of YS Biopharma and may affect the trading price of the Ordinary Shares.

Some provisions of the Amended YS Biopharma Articles may discourage, delay or prevent a change in control of YS Biopharma or management that shareholders may consider favorable. These provisions, which are summarized below, are expected to discourage coercive takeover practices and inadequate takeover bids. These provisions are also designed to encourage persons seeking to acquire control of YS Biopharma to first negotiate with YS Biopharma's Board. However, these provisions could also have the effect of discouraging others from attempting hostile takeovers and, as a consequence, they may also inhibit temporary fluctuations in the market price of the Ordinary Shares

[Table of Contents](#)

and/or YS Biopharma Preference Shares that often result from actual or rumored hostile takeover attempts. These provisions may also have the effect of preventing changes in the management of YS Biopharma. It is possible that these provisions could make it more difficult to accomplish transactions that shareholders may otherwise deem to be in their best interests.

- The Amended YS Biopharma Articles only permit YS Biopharma's shareholders together holding at least 10% of the voting power of all the then issued and outstanding ordinary shares which carry the right to vote to requisition a general meeting.
- The Amended YS Biopharma Articles require the affirmative vote of the holders of at least two-thirds in voting power of all the then outstanding ordinary shares as being entitled to do so to pass any special resolution, which special resolution is required to, among others, amend the memorandum and articles of association or approve a merger.
- Under the Amended YS Biopharma Articles, the number of directors shall be not less than three directors (or such greater number as may be approved by special resolution upon an amendment and/or restatement of the Amended YS Biopharma Articles). The directors shall be appointed and removed by ordinary resolution of the shareholders (except with regard to the removal of the Chairperson, who may be removed from office only by a special resolution).

In addition, these provisions may make it difficult and expensive for a third party to pursue a tender offer, change in control or takeover attempt that is opposed by YS Biopharma's management or YS Biopharma's Board. Shareholders who might desire to participate in these types of transactions may not have an opportunity to do so, even if the transaction is favorable to shareholders. These anti-takeover provisions could substantially impede the ability of shareholders to benefit from a change in control or change YS Biopharma's management and YS Biopharma's Board and, as a result, may adversely affect the market price of the Ordinary Shares and your ability to realize any potential change of control premium.

The warrant agreement relating to the Warrants provides YS Biopharma agrees that any action, proceeding or claim against YS Biopharma arising out of or relating in any way to such agreement will be brought and enforced in the courts of the State of New York or the United States District Court for the Southern District of New York, and that it irrevocably submits to such jurisdiction, which will be the exclusive forum for any such action, proceeding or claim. This exclusive forum provision could limit the ability of holders of the Warrants to obtain what they believe to be a favorable judicial forum for disputes related to such agreement.

In connection with the Business Combination, YS Biopharma entered into a Warrant Assignment Agreement pursuant to which Summit assigned to YS Biopharma all of its rights, title, interests, and liabilities and obligations in and under the Warrant Agreement, dated June 8, 2021, by and between Summit and Continental Stock Transfer & Trust Company. The Warrant Assignment Agreement provides that any action, proceeding or claim against YS Biopharma arising out of or relating in any way to such agreement, except for claims for which the federal courts have exclusive jurisdiction, such as lawsuits brought to enforce any duty or liability created by the Exchange Act or the rules and regulations thereunder, shall be brought and enforced in the courts of the State of New York or the United States District Court for the Southern District of New York, which will be the exclusive forum for any such action, proceeding or claim.

The exclusive forum provision in the Warrant Assignment Agreement may limit the ability of holders of the Warrants to bring a claim in a judicial forum that it finds favorable for disputes related to the Warrant Assignment Agreement, which may discourage such lawsuits against YS Biopharma and its directors or officers. Alternatively, if a court were to find this exclusive forum provision inapplicable to, or unenforceable in respect of, one or more of the specified types of actions or proceedings, YS Biopharma may incur additional costs associated with resolving such matters in other jurisdictions, which could adversely affect its business, financial condition and results of operations and result in a diversion of the time and resources of its management and board of directors.

If YS Group does not meet the expectations of equity research analysts, if they do not publish research or reports about YS Group's business or if they issue unfavorable commentary or downgrade the Ordinary Shares, the price of the Ordinary Shares could decline.

The trading market for the Ordinary Shares will rely in part on the research and reports that equity research analysts publish about YS Group and its business. The analysts' estimates are based upon their own opinions and are often different from YS Biopharma's estimates or expectations. These analysts make projections based on their independent

[Table of Contents](#)

opinions, which may differ from YS Group's internal estimates or expectations. If YS Group's actual results of operations do not meet these projections, or if analysts revise their estimates downwards, the price of the Ordinary Shares could decline significantly. Moreover, YS Group's reputation and the price of the Ordinary Shares could decline if one or more securities analysts downgrade the Ordinary Shares or if those analysts issue other unfavorable commentary or cease publishing reports about YS Biopharma or its business.

Furthermore, in some instances, equity research analysts may publish opinions or estimates about YS Biopharma's business that YS Biopharma believes are incorrect or misleading. Rectifying these misperceptions could require significant time and resources, which may distract its management from other strategic initiatives. Despite its efforts, YS Biopharma may not be able to correct these misperceptions effectively, which could negatively impact the perception of its company and harm its stock price.

YS Biopharma's issuance of additional share capital in connection with financings, acquisitions, investments, YS Biopharma's equity incentive plans or otherwise will dilute all other shareholders.

YS Biopharma expects to issue additional share capital in the future that will result in dilution to all other shareholders. YS Biopharma expects to grant equity awards to employees and directors under its equity incentive plans. YS Biopharma may also raise capital through equity financings in the future. As part of YS Biopharma's business strategy, YS Biopharma may acquire, make investments in or engage in strategic partnerships with companies, solutions or technologies and issue equity securities to pay for any such acquisition, investment or partnership. Any such issuances of additional share capital may cause shareholders to experience significant dilution of their ownership interests and the per share value of the Ordinary Shares to decline.

YS Biopharma is an emerging growth company and may take advantage of certain reduced reporting requirements.

YS Biopharma is an "emerging growth company," as defined in the JOBS Act, and YS Biopharma may take advantage of certain exemptions from various requirements applicable to other public companies that are not emerging growth companies including, most significantly, not being required to comply with the auditor attestation requirements of Section 404 of Sarbanes-Oxley Act of 2002 for so long as YS Biopharma is an emerging growth company. As a result, if YS Biopharma elects not to comply with such auditor attestation requirements, YS Biopharma's investors may not have access to certain information they may deem important.

YS Biopharma is a foreign private issuer within the meaning of the rules under the Exchange Act, and as such YS Biopharma is exempt from certain provisions applicable to U.S. domestic public companies.

Because YS Biopharma qualifies as a foreign private issuer under the Exchange Act, YS Biopharma is exempt from certain provisions of the securities rules and regulations in the United States that are applicable to U.S. domestic issuers, including:

- the rules under the Exchange Act requiring the filing with the SEC of quarterly reports on Form 10-Q or current re-ports on Form 8-K;
- the sections of the Exchange Act regulating the solicitation of proxies, consents, or authorizations in respect of a security registered under the Exchange Act;
- the sections of the Exchange Act requiring insiders to file public reports of their stock ownership and trading activities and liability for insiders who profit from trades made in a short period of time; and
- the selective disclosure rules by issuers of material nonpublic information under Regulation FD.

YS Biopharma is required to file an annual report on Form 20-F within four months of the end of each fiscal year. In addition, YS Biopharma intends to publish its results on a quarterly basis as press releases, distributed pursuant to the rules and regulations of Nasdaq. However, the information YS Biopharma is required to file with or furnish to the SEC is less extensive and less timely compared to that required to be filed with the SEC by U.S. domestic issuers. As a result, you may not be afforded the same protections or information that would be made available to you were you investing in a U.S. domestic issuer.

YS Biopharma may lose its foreign private issuer status in the future, which could result in significant additional costs and expenses.

As a foreign private issuer, YS Biopharma is not required to comply with all of the periodic disclosure and current reporting requirements of the Exchange Act. The determination of foreign private issuer status is made annually on the last business day of an issuer's most recently completed second fiscal quarter. In the future, YS Biopharma would lose its foreign private issuer status if (1) more than 50% of YS Biopharma's outstanding voting securities are owned by U.S. residents and (2) a majority of YS Biopharma's directors or executive officers are U.S. citizens or residents, or YS Biopharma fails to meet additional requirements necessary to avoid loss of foreign private issuer status. If YS Biopharma loses its foreign private issuer status, YS Biopharma will be required to file with the SEC periodic reports and registration statements on U.S. domestic issuer forms, which are more detailed and extensive than the forms available to a foreign private issuer. YS Biopharma will also have to mandatorily comply with U.S. federal proxy requirements, and YS Biopharma's officers, directors and principal shareholders will become subject to the short-swing profit disclosure and recovery provisions of Section 16 of the Exchange Act. In addition, YS Biopharma will lose its ability to rely upon exemptions from certain corporate governance requirements under the listing rules of Nasdaq. As a U.S. listed public company that is not a foreign private issuer, YS Biopharma will incur significant additional legal, accounting and other expenses that YS Biopharma will not incur as a foreign private issuer.

As an exempted company incorporated in the Cayman Islands, YS Biopharma is permitted to adopt certain home country practices in relation to corporate governance matters that differ significantly from Nasdaq's corporate governance requirements; these practices may afford less protection to shareholders. If YS Biopharma opts to rely on such exemptions in the future, such decision might afford less protection to holders of YS Biopharma's ordinary shares.

As a Cayman Islands exempted company that will be listed on the Nasdaq Stock Market LLC, YS Biopharma will be subject to the Nasdaq listing standards. Section 5605(b)(1), Section 5605(c)(2) and Section 5635(c) of the Nasdaq Listing Rules require listed companies to have, among other things, a majority of its board members to be independent, an audit committee of at least three members and shareholders' approval on adoption of equity incentive awards plans. However, the Nasdaq rules permit a foreign private issuer like YS Biopharma to follow the corporate governance practices of its home country. The corporate governance practice in YS Biopharma's home country, the Cayman Islands, does not require a majority of YS Biopharma's board of directors to consist of independent directors or the implementation of a nominating and corporate governance committee. Since a majority of YS Biopharma's board of directors would not consist of independent directors if YS Biopharma relied on the foreign private issuer exemption, fewer board members would be exercising independent judgment and the level of board oversight on the management of YS Biopharma might decrease as a result. In addition, YS Biopharma could opt to follow Cayman Islands law instead of the Nasdaq requirements that mandate that YS Biopharma obtain shareholder approval for certain dilutive events, such as an issuance that will result in a change of control, certain transactions other than a public offering involving issuances of 20% or greater interests in the company and certain acquisitions of the shares or assets of another company. While YS Biopharma does not currently intend to follow home country practice in lieu of the above requirements, YS Biopharma could decide in the future to follow home country practice and its board of directors could make such a decision to depart from such requirements by ordinary resolution.

YS Biopharma is a "controlled company" within the meaning of the Nasdaq Stock Market listing rules and, as a result, may rely on exemptions from certain corporate governance requirements that provide protection to shareholders of other companies.

YS Biopharma is a "controlled company" as defined under the Nasdaq Stock Market listing rules because Mr. Yi Zhang beneficially controls more than 50% of the total voting power of all issued and outstanding Ordinary Shares through the acting-in-concert arrangement under the Concert Party Agreement. As a result, Mr. Yi Zhang has the ability to control or significantly influence the outcome of matters requiring approval by shareholders. For the details of the Concert Party Agreement, see "Major Shareholders and Related Party Transactions — Concert Party Agreement" and "Summary of the Prospectus — Overview." In addition, for so long as YS Biopharma remains a controlled company under that definition, it is permitted to elect to rely on, and may rely on, certain exemptions from corporate governance rules, including an exemption from the rule that a majority of its board of directors must be independent directors. YS Biopharma does not currently plan to utilize the exemptions available for controlled companies, but instead, it plans to rely on the exemption available for foreign private issuers to follow its home country governance practices. See "— Risks Related to Ownership of the Ordinary Shares — As an exempted company incorporated in the Cayman Islands, YS Biopharma is permitted to adopt certain home country practices in relation to corporate governance

[Table of Contents](#)

matters that differ significantly from Nasdaq's corporate governance requirements; these practices may afford less protection to shareholders. If YS Biopharma opts to rely on such exemptions in the future, such decision might afford less protection to holders of YS Biopharma's ordinary shares." If it ceases to be a foreign private issuer or if it cannot rely on the home country governance practice exemptions for any reason, it may decide to invoke the exemptions available for a controlled company as long as its remain a controlled company. As a result, you will not have the same protection afforded to shareholders of companies that are subject to these corporate governance requirements.

If YS Group fails to remediate its material weakness and implement and maintain an effective system of internal control over financial reporting, YS Group may be unable to accurately report its results of operations, meet its reporting obligations or prevent fraud.

YS Biopharma is a company with limited accounting personnel and other resources to address its internal control over financial reporting. As a company with less than \$1.235 billion in revenue for the last fiscal year, YS Group qualifies as an "emerging growth company" pursuant to the JOBS Act. An emerging growth company may take advantage of specified reduced reporting and other requirements that are otherwise applicable generally to public companies. These provisions include exemption from the auditor attestation requirement under Section 404 of the Sarbanes-Oxley Act of 2002 in the assessment of the emerging growth company's internal control over financial reporting ("ICFR"). YS Group's management has not completed an assessment of the effectiveness of its internal control and procedures over financial reporting and its independent registered public accounting firm has not conducted an audit of its ICFR. In connection with the audit of its consolidated financial statements as of and for the three fiscal years ended March 31, 2023, YS Group and its independent registered public accounting firm identified a material weakness in its ICFR as of March 31, 2023. As defined in the standards established by the PCAOB, a "material weakness" is a deficiency, or a combination of deficiencies, in the ICFR, such that there is a reasonable possibility that a material misstatement of its annual or interim consolidated financial statements will not be prevented or detected on a timely basis.

The material weakness identified relates to lack of sufficient competent financial reporting and accounting personnel with appropriate understanding of U.S. GAAP to design and implement formal period-end financial reporting policies and procedures to address complex U.S. GAAP technical accounting issues, and to prepare and review YS Group's consolidated financial statements and related disclosures in accordance with U.S. GAAP and financial reporting requirements set forth by the SEC. Neither YS Group nor its independent registered public accounting firm had undertaken a comprehensive assessment of its internal control under the Sarbanes-Oxley Act for purposes of identifying and reporting material weaknesses and other control deficiencies in its ICFR. Had YS Group performed a formal assessment of its ICFR or had its independent registered public accounting firm performed an audit of its ICFR, additional deficiencies may have been identified.

To remediate YS Group's material identified material weakness, YS Group adopted measures to improve its ICFR, including, among others: (i) hiring additional qualified accounting and financial personnel with appropriate knowledge and experience in U.S. GAAP accounting and SEC reporting, and (ii) organizing regular training for its accounting staffs, especially training related to U.S. GAAP and SEC reporting requirements. YS Group also plan to adopt additional measures to improve YS Group's ICFR, including among others creating U.S. GAAP accounting policies and procedures manual, which will be maintained, reviewed and updated, on a regular basis, to the latest U.S. GAAP accounting standards, and further hiring executive accounting personnel with strong knowledge and experience in U.S. GAAP accounting and SEC reporting.

The implementation of these measures, however, may not fully address the material weakness identified in YS Group's ICFR, and YS Group cannot conclude that it has been fully remedied. YS Group's failure to correct the material weakness or its failure to discover and address any other material weaknesses or deficiencies could result in inaccuracies in its financial statements and impair its ability to comply with applicable financial reporting requirements and related regulatory filings on a timely basis. Moreover, ineffective ICFR could significantly hinder its ability to prevent fraud.

As a result of being a public company, YS Biopharma is obligated to develop and maintain proper and effective internal controls over financial reporting, and any failure to maintain the adequacy of these internal controls may adversely affect investor confidence in YS Biopharma and, as a result, the value of the Ordinary Shares.

YS Biopharma is required, pursuant to Section 404 of the Sarbanes-Oxley Act, to furnish a report by management on, among other things, the effectiveness of its ICFR as of the end of the fiscal year that coincides with the filing of YS Biopharma's second annual report on Form 20-F. This assessment will need to include disclosure of any material

[Table of Contents](#)

weaknesses identified by YS Biopharma's management in its ICFR. In addition, YS Biopharma's independent registered public accounting firm will be required to attest to the effectiveness of its ICFR in YS Biopharma's first annual report required to be filed with the SEC following the date YS Biopharma is no longer an "emerging growth company."

YS Biopharma's current controls and any new controls that it develops may become inadequate because of changes in conditions in YS Biopharma's business. In addition, changes in accounting principles or interpretations could also challenge YS Biopharma's internal controls and require that YS Biopharma establishes new business processes, systems and controls to accommodate such changes. Additionally, if these new systems, controls or standards and the associated process changes do not give rise to the benefits that YS Biopharma expects or do not operate as intended, it could materially and adversely affect YS Biopharma's financial reporting systems and processes, YS Biopharma's ability to produce timely and accurate financial reports or the effectiveness of ICFR. Moreover, YS Biopharma's business may be harmed if YS Biopharma experiences problems with any new systems and controls that result in delays in their implementation or increased costs to correct any post-implementation issues that may arise.

During the evaluation and testing process of YS Biopharma's internal controls, if YS Biopharma identifies one or more material weaknesses in its ICFR, YS Biopharma will be unable to certify that its ICFR is effective. YS Biopharma cannot assure you that there will not be material weaknesses or significant deficiencies in its ICFR in the future. Any failure to maintain effective ICFR could severely inhibit YS Biopharma's ability to accurately report its financial condition or results of operations. If YS Biopharma is unable to conclude that its ICFR is effective, or if YS Biopharma's independent registered public accounting firm determines YS Biopharma has a material weakness or significant deficiency in its ICFR, YS Biopharma could lose investor confidence in the accuracy and completeness of its financial reports, the market price of the Ordinary Shares could decline, and YS Biopharma could be subject to sanctions or investigations by the SEC or other regulatory authorities. Failure to remedy any material weakness in YS Biopharma's ICFR, or to implement or maintain other effective control systems required of public companies, could also restrict YS Biopharma's future access to the capital markets.

The growth and expansion of YS Biopharma's business places a continuous, significant strain on its operational and financial resources. Further growth of YS Biopharma's operations to support its customer base, its platform, solutions and its internal controls and procedures may not be adequate to support YS Biopharma's operations. As YS Biopharma continues to grow, YS Biopharma may not be able to successfully implement requisite improvements to these systems, controls and processes, such as system access and change management controls, in a timely or efficient manner. Moreover, YS Biopharma's rapid expansion may necessitate a significant increase in the workforce and require YS Biopharma to manage multiple relationships with various partners, customers, and vendors. This could place additional stress on YS Biopharma's infrastructure and increase its management challenges, potentially disrupting its current operations. YS Biopharma's failure to improve its systems and processes, or its failure to operate in the intended manner, whether as a result of the growth of its business or otherwise, may result in its inability to accurately forecast its revenue and expenses, or to prevent certain losses. Moreover, the failure of YS Biopharma's systems and processes could undermine YS Biopharma's ability to provide accurate, timely and reliable reports on its financial and operating results and could impact the effectiveness of its ICFR. In addition, YS Biopharma's systems and processes may not prevent or detect all errors, omissions or fraud.

As a result of YS Biopharma's plans to expand operations, including to jurisdictions in which the tax laws may not be favorable, YS Biopharma's tax rate may fluctuate, its tax obligations may become significantly more complex and subject to greater risk of examination by taxing authorities or it may be subject to future changes in tax law, the impact of which could adversely affect YS Biopharma's after-tax profitability and financial results.

Because YS Biopharma does not have a long history of operating at its present scale and has significant expansion plans, YS Biopharma's effective tax rate may fluctuate in the future. Future effective tax rates could be affected by YS Biopharma's operating results before taxes, changes in the composition of operating income and earnings in countries or jurisdictions with differing tax rates, including as YS Biopharma expands into additional jurisdictions, changes in the amount of YS Biopharma's deferred tax assets and liabilities, changes in accounting and tax standards or practices, changes in tax laws, changes in the tax treatment of share-based compensation, and YS Biopharma's ability to structure its operations in an efficient and competitive manner.

Due to the complexity of multinational tax obligations and filings, YS Biopharma may have a heightened risk related to audits, examinations or administrative appeals by taxing authorities. Outcomes from current and future tax audits, examinations or administrative appeals could have an adverse effect on YS Biopharma's after-tax profitability and

financial condition. Additionally, several tax authorities have increasingly focused attention on intercompany transfer pricing with respect to sales of products and services and the use of intangibles. Tax authorities could disagree with YS Biopharma's intercompany charges, cross-jurisdictional transfer pricing or other matters and assess additional taxes. If YS Biopharma does not prevail in any such disagreements, its profitability may be affected.

YS Biopharma's after-tax profitability and financial results may also be adversely impacted by changes in the relevant tax laws and tax rates, treaties, regulations, administrative practices and principles, judicial decisions and interpretations thereof, in each case, possibly with retroactive effect. For example, the Multilateral Convention to Implement Tax Treaty Related Measures to Prevent Base Erosion and Profit Shifting entered into force in 2018 among the jurisdictions that have ratified it. Additionally, many countries and organizations, such as the Organization for Economic Cooperation and Development, are also actively considering changes to existing tax laws or have proposed or enacted new laws that could increase YS Biopharma's tax obligations in countries in which it does business or cause YS Biopharma to change the way it operates its business. These recent changes and proposals could negatively impact YS Biopharma's taxation, especially as YS Biopharma expands its relationships and operations internationally.

If YS Biopharma or any of its subsidiaries is treated as a "controlled foreign corporation" for U.S. federal income tax purposes, certain U.S. Holders may be subject to adverse U.S. federal income tax consequences.

If a "United States person" (as defined in Section 7701(a)(30) of the Code) is treated as owning (directly, indirectly, or constructively) at least 10% of the total combined voting power of all classes of YS Biopharma's shares entitled to vote or at least 10% of the total value of shares of all classes of YS Biopharma's shares, such person may be treated as a "United States shareholder" with respect to each "controlled foreign corporation" ("CFC") within the meaning of Section 957(a) of the Code in YS Group (if any), which may subject such person to adverse U.S. federal income tax consequences. Specifically, a United States shareholder of a CFC may be required to annually report and include in its U.S. taxable income its pro rata share of such CFC's "Subpart F income," "global intangible low-taxed income," and investments in U.S. property, whether or not YS Biopharma makes any distributions of profits or income of such CFC to such United States shareholder. If a U.S. Holder is treated as a United States shareholder of a CFC, failure to comply with applicable reporting obligations may subject such holder to significant monetary penalties and may extend the statute of limitations with respect to such holder's U.S. federal income tax return for the taxable year for which reporting was due. Additionally, an individual United States shareholder of a CFC generally would be denied certain tax deductions or foreign tax credits in respect of its income that may otherwise be allowable to a United States shareholder that is a U.S. corporation.

In light of YS Biopharma's structure, certain of its non-U.S. subsidiaries may be CFCs. YS Biopharma cannot provide any assurances that it will assist U.S. Holders in determining whether YS Biopharma or any of its non-U.S. subsidiaries is treated as a CFC or whether any U.S. Holder is treated as a United States shareholder with respect to any such CFC, nor does YS Biopharma expect to furnish to any United States shareholders information that may be necessary to comply with the aforementioned reporting and tax paying obligations. U.S. Holders should consult their tax advisors regarding the potential application of the CFC rules to an investment in Ordinary Shares.

If YS Biopharma is or becomes a "passive foreign investment company" for U.S. federal income tax purposes, U.S. Holders may be subject to adverse U.S. federal income tax consequences.

Based on the income, assets, and operations of YS Biopharma and its subsidiaries, YS Biopharma does not believe that it was PFIC in the taxable year ended March 31, 2023, although there can be no assurance that the IRS or a court will not challenge its position in this regard. The determination of whether YS Biopharma is a PFIC is made on an annual basis and will depend on the composition of income and assets of YS Biopharma and its subsidiaries, and the value of the assets of YS Biopharma and its subsidiaries, from time to time. Specifically, for any taxable year, a non-U.S. corporation will be classified as a PFIC for U.S. federal income tax purposes if either: (1) 75% or more of its gross income in such taxable year is passive income, or (2) 50% or more of the value of its assets (generally based on an average of the quarterly values of the assets) during such taxable year is attributable to assets that produce or are held for the production of passive income. The calculation of the value of the assets of YS Biopharma and its subsidiaries will be based, in part, on the quarterly market value of Ordinary Shares, which is subject to change and may be volatile.

The determination of whether YS Biopharma is a PFIC also will depend, in part, on how, and how quickly, it uses its liquid assets and cash, including the cash acquired from Summit in the Business Combination. If YS Biopharma were to retain significant amounts of liquid assets, including cash, the risk of YS Biopharma being classified as a PFIC

[Table of Contents](#)

may substantially increase. Because there are uncertainties in the application of the relevant rules and PFIC status is a factual determination made annually after the close of each taxable year, there can be no assurance that YS Biopharma will not be a PFIC for any future taxable year, and no opinion of counsel has or will be provided regarding the classification of YS Biopharma as a PFIC. If YS Biopharma were classified as a PFIC for any taxable year during which a U.S. Holder held Ordinary Shares, YS Biopharma generally would continue to be treated as a PFIC for all succeeding taxable years during which such U.S. Holder held Ordinary Shares.

If YS Biopharma were classified as a PFIC, such characterization could result in adverse U.S. federal income tax consequences to U.S. Holders, including increased tax liabilities under U.S. federal income tax laws and regulations and burdensome reporting requirements. YS Biopharma cannot assure any U.S. Holder that YS Biopharma will not be a PFIC for the current taxable year or any future taxable year. U.S. Holders should consult their tax advisors regarding the circumstances that may cause YS Biopharma to be classified as a PFIC and the consequences if YS Biopharma is classified as a PFIC.

YS Biopharma may not be able to satisfy listing requirements of the Nasdaq Stock Market or obtain or maintain a listing of the Ordinary Shares on the Nasdaq Stock Market.

As the Ordinary Shares are listed on the Nasdaq Stock Market, YS Biopharma must meet certain financial and liquidity criteria to maintain such listing. If YS Biopharma violates the Nasdaq Stock Market's listing requirements, or if YS Biopharma fails to meet any of the Nasdaq Stock Market's listing standards, the Ordinary Shares may be delisted. In addition, YS Biopharma's board of directors may determine that the cost of maintaining YS Biopharma's listing on a national securities exchange outweighs the benefits of such listing. The delisting of the Ordinary Shares from the Nasdaq Stock Market could significantly impair YS Biopharma's ability to raise capital and the value of your investment.

Because YS Biopharma does not expect to pay dividends in the foreseeable future, you must rely on price appreciation of the Ordinary Shares for return on your investment.

YS Biopharma currently intends to retain most, if not all, of its available funds and any future earnings after this offering to fund the development and growth of its business. As a result, YS Biopharma does not expect to pay any cash dividends in the foreseeable future. Therefore, you should not rely on an investment in the Ordinary Shares as a source for any future dividend income.

YS Biopharma's board of directors has complete discretion as to whether to distribute dividends, subject to certain requirements of Cayman Islands law. In addition, YS Biopharma's shareholders may by ordinary resolution declare a dividend, but no dividend may exceed the amount recommended by YS Biopharma's directors. Under Cayman Islands law, a Cayman Islands company may pay a dividend out of either profit or share premium account, provided that in no circumstances may a dividend be paid if this would result in the company being unable to pay its debts as they fall due in the ordinary course of business. Even if YS Biopharma's board of directors decides to declare and pay dividends, the timing, amount and form of future dividends, if any, will depend on its future results of operations and cash flow, its capital requirements and surplus, the amount of distributions, if any, received by it from its subsidiaries, its financial condition, contractual restrictions and other factors deemed relevant by its board of directors. Accordingly, the return on your investment in the Ordinary Shares will likely depend entirely upon any future price appreciation of the Ordinary Shares. There is no guarantee that the Ordinary Shares will appreciate in value in the future or even maintain the price at which you purchased the Ordinary Shares. You may not realize a return on your investment in the Ordinary Shares and you may even lose your entire investment in the Ordinary Shares.

YS Biopharma's founder, Mr. Yi Zhang, will have considerable influence over YS Biopharma and its corporate matters.

YS Biopharma's founder, Mr. Yi Zhang beneficially controls more than 50% of the total voting power of all issued and outstanding Ordinary Shares through the acting-in-concert arrangement under the Concert Party Agreement. As a result, Mr. Yi Zhang has considerable power to control actions that require shareholder approval under Cayman Islands law, such as approving any statutory merger pursuant to the Cayman Companies Act and amending YS Biopharma's memorandum and articles of association. This control will limit your ability to influence corporate matters and may prevent transactions that would be beneficial to you, including discouraging others from pursuing any potential merger, takeover or other change of control transactions, which could have the effect of depriving the holders of the Ordinary Shares of the opportunity to sell their shares at a premium over the prevailing market price.

Techniques employed by short sellers may drive down the market price of the Ordinary Shares.

Short selling is the practice of selling securities that the seller does not own but rather has borrowed from a third party with the intention of buying identical securities back at a later date to return to the lender. The short seller hopes to profit from a decline in the value of the securities between the sale of the borrowed securities and the purchase of the replacement shares, as the short seller expects to pay less in that purchase than it received in the sale. As it is in the short seller's interest for the price of the security to decline, many short sellers publish, or arrange for the publication of, negative opinions regarding the relevant issuer and its business prospects in order to create negative market momentum and generate profits for themselves after selling a security short. These short attacks have, in the past, led to selling of shares in the market.

Public companies listed in the United States that have a substantial majority of their operations in China have been the subject of short selling. Much of the scrutiny and negative publicity has centered on allegations of a lack of effective ICFR resulting in financial and accounting irregularities and mistakes, inadequate corporate governance policies or a lack of adherence thereto and, in many cases, allegations of fraud. As a result, many of these companies are now conducting internal and external investigations into the allegations and, in the interim, are subject to shareholder lawsuits and/or SEC enforcement actions.

YS Biopharma may be the subject of unfavorable allegations made by short sellers in the future. Any such allegations may be followed by periods of instability in the market price of the Ordinary Shares and negative publicity. If and when YS Biopharma becomes the subject of any unfavorable allegations, whether such allegations are proven to be true or untrue, YS Biopharma could have to expend a significant amount of resources to investigate such allegations and/or defend itself. While YS Biopharma would strongly defend against any such short seller attacks, YS Biopharma may be constrained in the manner in which YS Biopharma can proceed against the relevant short seller by principles of freedom of speech, applicable federal or state law or issues of commercial confidentiality. Such a situation could be costly and time-consuming and could distract YS Biopharma's management from growing its business. Even if such allegations are ultimately proven to be groundless, allegations against YS Biopharma could severely impact its business and shareholders' equity, and the value of any investment in the Ordinary Shares could be greatly reduced or rendered worthless.

Sales of the Ordinary Shares, or the perception of such sales, by YS Biopharma or the Selling Securityholders pursuant to this prospectus in the public market or otherwise could cause the market price for the Ordinary Shares to decline.

The sale of the Ordinary Shares in the public market or otherwise, including sales pursuant to this prospectus, or the perception that such sales could occur, could increase the volatility of the market price of the Ordinary Shares or result in a significant decline in the public trading price of the Ordinary Shares. These sales, or the possibility that these sales may occur, also might make it more difficult for YS Biopharma to sell equity securities in the future at a time and at a price that YS Biopharma deems appropriate. Resales of the Ordinary Shares may cause the market price of YS Biopharma's securities to drop significantly, even if YS Biopharma's business is doing well.

The securities registered for resale by the Selling Securityholders named in the prospectus are subject to 180 days lock-up period from March 16, 2023. The lockup requirements will cease to apply after the date on which the closing price of the Ordinary Shares equals or exceeds \$12.00 per share for any 20 trading days within any 30 trading day period commencing at least 150 days after March 16, 2023. These shares will, upon expiration of such lock-up period, become eligible for resale without contractual restrictions. See "Shares Eligible for Future Sale" for details. Following the expiration of the applicable lock-up described in this prospectus and as restrictions on resale end and registration statements are available for use, the market price of the Ordinary Shares could continue to decline if the holders of restricted or locked up shares sell them or are perceived by the market as intending to sell them. As such, sales of a substantial number of the Ordinary Shares in the public market could occur at any time. These sales, or the perception in the market that the holders of a large number of shares intend to sell such shares, could reduce the market price of the Ordinary Shares.

This prospectus registers the Ordinary Shares being offered for resale pursuant to this prospectus by the Selling Securityholders, which represent approximately 25.9% of the outstanding Ordinary Shares as of the date of this prospectus. Despite a potential decline in the public trading price of the Ordinary Shares, certain securityholders, including certain Selling Securityholders may still experience a positive rate of return on the securities that they sell pursuant to this prospectus as they have acquired the securities registered hereunder at prices substantially below current market prices, and may therefore have an incentive to sell their securities.

Table of Contents

Specifically, (1) Hui Shao purchased 2,002,780 Ordinary Shares at an average price of approximately \$0.00002 per share (including 1,802,780 Ordinary Shares held by Mountainview Investment Holdings LLC, a limited liability company incorporated under the laws of the State of Delaware and wholly-controlled by Mr. Hui Shao, and 200,000 Ordinary Shares directly held by Mr. Hui Shao), (2) Chunyuan Wu purchased 97,500 Ordinary Shares at an average price of approximately \$0.00002 per share, (3) Sunangal Ajit Shetty & Christine Maria M. Clerinx purchased 27,500 Ordinary Shares at an average price of approximately \$3.6 per share, (4) Viren T MEHTA & Amita RODMAN (as Trustees of V Mehta RLT & A Rodman RLT) purchased 35,000 Ordinary Shares at an average price of approximately \$3.6 per share, (5) Stanley Yi Chang purchased 82,111 Ordinary Shares at an average price of approximately \$0.12 per share, (6) Viren T Mehta purchased 72,500 Ordinary Shares at an average price of approximately \$0.00002 per share, (7) Sunangal Ajit Shetty purchased 72,500 Ordinary Shares at an average price of approximately \$0.00002 per share, (8) Asia Ventures II L.P. purchased 2,718,499 Ordinary Shares at an average price of approximately \$3.71 per share, (9) F-Prime Capital Partners Healthcare Fund III LP purchased 1,165,071 Ordinary Shares at an average price of approximately \$3.71 per share, (10) HHSUM XXXVI Holdings Limited purchased 751,790 Ordinary Shares at an average price of approximately \$6.65 per share, (11) Entities affiliated with OrbiMed purchased 4,298,465 Ordinary Shares at an average price of approximately \$6.27 per share, (12) Haitong Xu Yu International Limited purchased 187,948 Ordinary Shares at an average price of approximately \$6.65 per share, (13) Epiphron Capital (Hong Kong) Limited purchased 187,948 Ordinary Shares at an average price of approximately \$8.91 per share, (14) 3W Global Investment Limited purchased 187,948 Ordinary Shares at an average price of approximately \$6.65 per share, (15) Oceanpine Investment Fund II LP purchased 4,105,596 Ordinary Shares at an average price of approximately \$9.74 per share, (16) AIHC Master Fund purchased 718,480 Ordinary Shares at an average price of approximately \$9.74 per share, (17) 3W Global Fund purchased 2,052,798 Ordinary Shares at an average price of approximately \$9.74 per share, (18) MSA China Growth Fund II L.P. purchased 1,129,039 Ordinary Shares at an average price of approximately \$9.74 per share, (19) Superstring Capital Master Fund LP purchased 307,920 Ordinary Shares at an average price of approximately \$9.74 per share, (20) Wudaokou Capital Limited purchased 307,920 Ordinary Shares at an average price of approximately \$9.74 per share, (21) Gennex China Growth Fund purchased 205,280 Ordinary Shares at an average price of approximately \$9.74 per share, (22) Adjuvant Global Health Technology Fund, L.P. purchased 2,436,298 Ordinary Shares at an average price of approximately \$5.06 per share, and (23) Adjuvant Global Health Technology Fund DE, L.P. purchased 466,671 Ordinary Shares at an average price of approximately \$5.06 per share.

As such, based on the closing price of Ordinary Shares at \$0.489599 on January 22, 2024 and assuming all the eligible Ordinary Shares were to be sold, (1) Hui Shao would experience a potential profit of up to \$0.489579 per share, or approximately \$980,519 in aggregate, (2) Chunyuan Wu would experience a potential profit of up to \$0.489579 per share, or approximately \$47,734 in aggregate, (3) Stanley Yi Chang would experience a potential profit of up to \$0.369599 per share, or approximately \$30,348 in aggregate, (4) Viren T Mehta would experience a potential profit of up to \$0.489579 per share, or approximately \$35,494 in aggregate, and (5) Sunangal Ajit Shetty would experience a potential profit of up to \$0.489579 per share, or approximately \$35,494 in aggregate. The other Selling Securityholders would not recognize profit based on the current trading price of Ordinary Shares as of January 22, 2024.

Public securityholders who purchased their YS Biopharma's securities at higher prices than the Selling Securityholders may experience lower rates of return (if any) than the Selling Securityholders, due to differences in purchase price and the potential trading price at which they may be able to sell.

In addition, YS Biopharma adopted an amended and restated share incentive plan in 2022 to resume all the terms and conditions of a share incentive plan previously adopted in 2020 to continue to incentivize YS Group's directors, employees and consultants for future development of business and R&D activities. YS Biopharma may grant additional options or share-based awards to employees, directors and consultants in the future. To the extent that any of these awards are vested and exercised, and any of such shares are sold in the market, it could have an adverse effect on the market price of the Ordinary Shares.

CAPITALIZATION

The following table sets forth our total capitalization as of September 30, 2023.

As we will not receive any proceeds from the sale of Ordinary Shares sold by the Selling Securityholders, no further change is disclosed on a pro forma basis to reflect sales of shares pursuant to this prospectus.

The information in the following table should be read in conjunction with the financial statements and notes thereto and other financial information included in this prospectus, any prospectus supplement or incorporated by reference in this prospectus. Our historical results do not necessarily indicate our expected results for any future periods.

	As of September 30, 2023	
	Actual	
	RMB	US\$
Cash and cash equivalents	259,905,532	36,199,550
Total liabilities	1,054,186,774	146,826,760
Equity		
Ordinary shares	12,297	1,713
Additional paid-in capital	2,656,891,036	370,050,842
Accumulated Deficit	(2,048,560,763)	(285,322,817)
Accumulated other comprehensive income (loss)	(51,246,240)	(7,137,559)
Total Equity	557,096,330	77,592,179
Total Capitalization	497,090,444	69,234,581

SELECTED HISTORICAL FINANCIAL DATA OF YS BIOPHARMA

The following tables present the selected consolidated financial and other data of YS Biopharma and its subsidiaries.

The financial data set forth below should be read in conjunction with, and is qualified by reference to, “YS Biopharma’s Management’s Discussion and Analysis of Financial Condition and Results of Operations” and the consolidated financial statements and notes thereto included elsewhere in this prospectus. YS Biopharma’s consolidated financial statements are prepared and presented in accordance with U.S. GAAP. The historical results included below and elsewhere in this prospectus are not indicative of the future performance of YS Biopharma following the Business Combination. You should read the following information in conjunction with those financial statements and accompanying notes included elsewhere in this prospectus and “YS Biopharma’s Management’s Discussion and Analysis of Financial Condition and Results of Operations.”

The selected consolidated statements of operations and other comprehensive loss data for the fiscal years ended March 31, 2021, 2022 and 2023 and consolidated statements of financial position data as of March 31, 2022 and 2023 have been derived from the audited consolidated balance sheet of YS Biopharma and its subsidiaries as of March 31, 2022 and 2023, and the related consolidated statements of operations and other comprehensive loss for each of the fiscal years in the three-year period ended March 31, 2023 included elsewhere in this prospectus.

The selected unaudited consolidated statements of operations and other comprehensive loss data for the six months ended September 30, 2023 and unaudited consolidated statement of financial position data as of September 30, 2023 have been derived from the unaudited consolidated balance sheet of YS Biopharma and its subsidiaries as of September 30, 2023, and the related unaudited consolidated statements of the operations and other comprehensive loss for the six months ended September 30, 2023, also included elsewhere in this prospectus.

Summary statements of operations and comprehensive loss:

	For the Six Months Ended September 30,		
	2022	2023	2023
	(RMB)	(RMB)	(US\$)
	(Unaudited)	(Unaudited)	(Unaudited)
Revenues	399,534,723	273,092,454	\$ 38,036,220
Cost of revenues	93,700,779	52,187,142	7,268,607
Gross profit	305,833,944	220,905,312	30,767,613
Operating expenses:			
Selling and marketing	150,228,079	157,700,204	21,964,429
General and administrative	49,587,013	67,610,523	9,416,770
Research and development	123,861,107	178,853,200	24,910,610
Total operating expenses	323,676,199	404,163,927	56,291,809
Loss from operations	(17,842,255)	(183,258,615)	(25,524,196)
Other income (expenses):			
Late fee related to social security insurance	(299,417)	(446,176)	(62,143)
Government grants	22,456,691	14,627,559	2,037,321
Interest income	266,433	1,957,620	272,657
Interest expense	(15,215,867)	(14,926,098)	(2,078,902)
Fair value changes of warrant liability	—	6,851,308	954,248
Other income (expense), net	74,675	(148,749)	(20,718)
Total other income, net	7,282,515	7,915,464	1,102,463
Loss before income taxes	(10,559,740)	(175,343,151)	(24,421,733)
Income tax (expense) benefit	(565,625)	820,353	114,258
Net loss	(11,125,365)	(174,522,798)	(24,307,475)
Accretion to redemption value of convertible redeemable preferred shares	(72,083,238)	—	—
Net loss attributable to YS Group	(83,208,603)	(174,522,798)	\$ (24,307,475)
Net loss	(11,125,365)	(174,522,798)	\$ (24,307,475)
Other comprehensive (loss) income: foreign currency translation (loss) gain	(168,653,952)	3,165,843	440,937
Total comprehensive loss	(179,779,317)	(171,356,955)	\$ (23,866,538)
Loss per share:			
– Basic and Diluted	(0.18)	(1.88)	\$ (0.26)
Weighted average number of ordinary shares outstanding:			
– Basic and Diluted	61,785,466	93,058,197	93,058,197

[Table of Contents](#)

	Years Ended March 31,			
	2021	2022	2023	2023
	(RMB)	(RMB)	(RMB)	(US\$)
Revenues	257,015,929	502,949,894	687,201,070	\$ 100,004,521
Cost of revenues	59,656,877	117,066,090	153,360,262	22,317,660
Gross profit	197,359,052	385,883,804	533,840,808	77,686,861
Operating expenses:				
Selling and marketing	73,485,259	185,999,704	272,927,356	39,717,589
General and administrative	155,334,386	107,620,500	81,595,277	11,874,103
Research and development	94,387,144	211,222,263	318,700,526	46,378,702
Total operating expenses	323,206,789	504,842,467	673,223,159	97,970,394
Loss from operations	(125,847,737)	(118,958,663)	(139,382,351)	(20,283,533)
Other income (expenses):				
Late fees related to income tax	(11,464,741)	—	—	—
Late fees related to taxes other than income tax	(7,261,947)	(231,231)	(3,603)	(524)
Late fees related to social security insurance	(7,701,793)	(1,852,378)	(747,609)	(108,795)
Government grants	3,530,405	23,020,413	26,072,517	3,794,187
Financial expenses, net	(29,689,927)	(2,717,433)	(30,857,673)	(4,490,544)
Fair value changes of warrant liability	—	—	21,358	3,108
Other income (expense), net	4,063,743	(327,987)	551,760	80,295
Total other (expense) income, net	(48,524,260)	17,891,384	(4,963,250)	(722,273)
Loss before income taxes	(174,371,997)	(101,067,279)	(144,345,601)	(21,005,806)
Income tax expense	(17,454,245)	(4,937,122)	(1,133,504)	(164,952)
Net loss	(191,826,242)	(106,004,401)	(145,479,105)	(21,170,758)
Accretion to redemption value of convertible redeemable preferred shares	(16,610,297)	(130,662,326)	(137,991,697)	(20,081,159)
Net loss attributable to YS Group	(208,436,539)	(236,666,727)	(283,470,802)	\$ (41,251,917)
Net loss	(191,826,242)	(106,004,401)	(145,479,105)	\$ (21,170,758)
Other comprehensive income (loss): foreign currency translation adjustment	22,455,217	38,864,606	(137,500,062)	(20,009,614)
Total comprehensive loss	(169,371,025)	(67,139,795)	(282,979,167)	\$ (41,180,372)
Loss per share*:				
– Basic and Diluted	(3.10)	(1.71)	(1.56)	\$ (0.23)
Weighted average number of ordinary shares outstanding*:				
– Basic and Diluted	61,827,883	61,827,883	93,058,197	93,058,197

* Gives retroactive effect to reflect the reorganization in February 2021 and business combination in March 2023. The accompanying notes are an integral part of these consolidated financial statements.

Summary balance sheets:

	As of March 31,			As of September 30,	
	2022	2023	2023	2023	2023
	(RMB)	(RMB)	(US\$)	(RMB)	(US\$)
ASSETS					
Current assets	764,764,393	1,035,978,664	150,760,170	934,605,218	130,171,483
Non-current assets	676,988,748	683,774,947	99,505,938	676,677,886	94,247,456
Total assets	1,441,753,141	1,719,753,611	\$ 250,266,108	1,611,283,104	\$ 224,418,939
LIABILITIES, MEZZANINE EQUITY AND SHAREHOLDERS' (DEFICIT)/EQUITY					
Current liabilities	475,914,160	658,761,944	95,865,936	663,115,417	92,358,480
Non-current liabilities	294,586,777	332,538,382	48,392,447	391,071,357	54,468,280
Total liabilities	770,500,937	991,300,326	144,258,383	1,054,186,774	146,826,760
Mezzanine equity	1,370,221,392	—	—	—	—
Shareholders' (deficit)/equity	(698,969,188)	728,453,285	106,007,725	557,096,330	77,592,179
Total liabilities, mezzanine equity and shareholders' (deficit)/equity	1,441,753,141	1,719,753,611	\$ 250,266,108	1,611,283,104	\$ 224,418,939

Summary statements of cash flows:

	For the Six Months Ended September 30,		
	2022	2023	
	RMB	RMB	US\$
Net cash used in operating activities	(107,395,153)	(145,831,735)	(20,311,391)
Net cash used in investing activities	(19,024,351)	(23,421,694)	(3,262,165)
Net cash provided by financing activities	51,907,325	44,855,849	6,247,507
Effect of foreign exchange rate on cash and cash equivalents	30,471,942	13,933,287	1,940,621
Net increase (decrease) in cash and cash equivalents	(44,040,237)	(110,464,293)	(15,385,428)
Cash and restricted cash at the beginning of the fiscal year	271,067,503	370,369,825	51,584,978
Cash and restricted cash at the end of the fiscal year	227,027,266	259,905,532	36,199,550

	Fiscal Year Ended March 31,			
	2021	2022	2023	
	RMB	RMB	RMB	US\$
Net cash used in operating activities	(246,610,437)	(173,545,357)	(182,469,396)	(26,553,749)
Net cash used in investing activities	(104,238,941)	(298,923,958)	(56,981,720)	(8,292,230)
Net cash provided by financing activities	739,258,696	364,558,145	317,449,926	46,196,709
Effect of foreign exchange rate on cash and cash equivalents	(2,674)	(11,478,411)	21,303,512	3,100,180
Net increase (decrease) in cash and cash equivalents	388,406,644	(119,389,581)	99,302,322	14,450,910
Cash and restricted cash at the beginning of the fiscal year	2,050,440	390,457,084	271,067,503	39,446,935
Cash and restricted cash at the end of the fiscal year	390,457,084	271,067,503	370,369,825	53,897,845

USE OF PROCEEDS

All of the Ordinary Shares offered by the Selling Securityholders pursuant to this prospectus will be sold by the Selling Securityholders for their respective accounts. We will not receive any of the proceeds from such sales. We will pay certain expenses associated with the registration of the securities covered by this prospectus, as described in the section titled “Plan of Distribution.”

DIVIDEND POLICY

We have never declared or paid any cash dividend on our Ordinary Shares. We currently intend to retain any future earnings and do not expect to pay any dividends in the foreseeable future. Any further determination to pay dividends on our ordinary shares would be at the discretion of our board of directors, subject to applicable laws, and would depend on our financial condition, results of operations, capital requirements, general business conditions, and other factors that our board of directors may deem relevant.

MARKET OPPORTUNITIES

The information presented in this section has been derived from the F&S report, commissioned by YS Biopharma and issued in September 2022 by Frost & Sullivan, an independent research firm to provide information regarding the industry and market position of YS Biopharma in China.

Global Vaccine Market Overview

Vaccines, a type of preventative pharmaceutical product that provides active acquired immunity against one or several diseases, have gradually been recognized an effective means to suppress the global and regional spread of infectious diseases and represented a growing share of the expanding global pharmaceutical market, according to the F&S report. In terms of sales revenue, the global vaccine market increased from \$27.7 billion in 2017 to \$46.0 billion in 2021, at a CAGR of 13.5%, and is expected to reach \$131.0 billion in 2030, at a CAGR of 12.3% from 2021 to 2030, mainly driven by the launch of innovative vaccines and sales growth in emerging markets such as China, according to the same source.

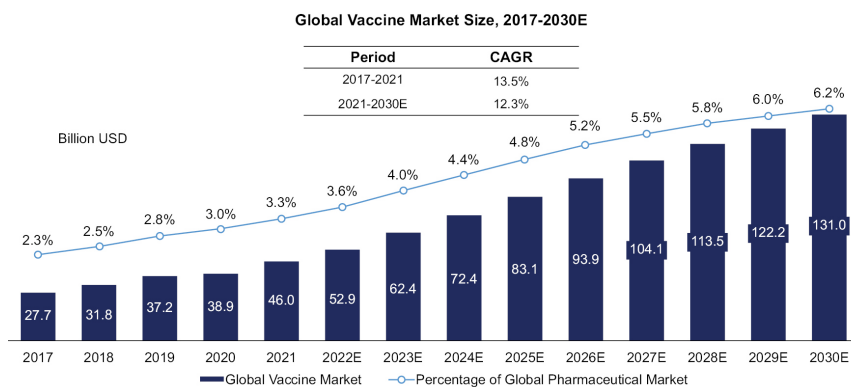

Note: the global market size is revenue based and forecasted based on the data of 2022Q3. COVID-19 vaccine market is currently not taken into consideration

Source: Expert interview, company annual report, Frost & Sullivan analysis

China's Vaccine Market

Overview of China's vaccine market

China's vaccine market has generally increased rapidly in the past few years and is expected to continue to grow significantly in the near future. According to the F&S report, China's vaccine market, in terms of market production value, generally increased from RMB31.2 billion in 2017 to RMB92.6 billion in 2021, at a CAGR of 31.3%, and is expected to reach RMB338.6 billion in 2030, at a CAGR of 15.5% from 2021 to 2030.

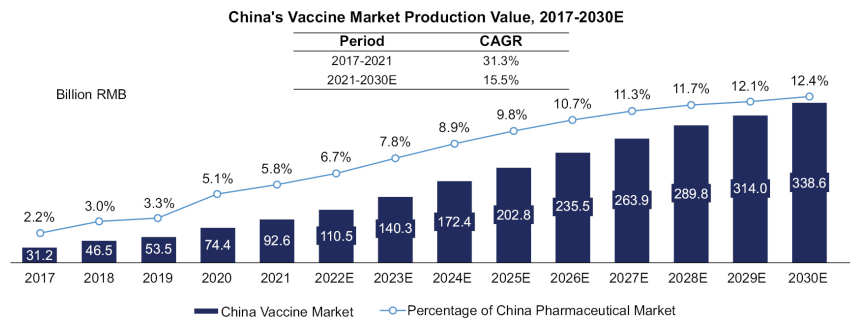

Note: the China market size is production value based and forecasted based on 2021 lot release data. COVID-19 vaccine market is currently not taken into consideration. The historical data is gathered from NIFDC of China which is highly regulatorily driven and depends on the policy enacted by the government and working efficiency of NIFDC in those years. The forecasted data is made based the assumption that the working efficiency of NIFDC would not greatly fluctuate in the future while the market is continuously driven by the current unmet need in the vaccine industry of China.

Source: Expert interview, NIFDC, Frost & Sullivan analysis

[Table of Contents](#)

Vaccines in China can be categorized into Category I vaccines and Category II vaccines. Category I vaccines refer to the mandatory vaccines purchased by provincial-CDCs through government-organized tenders and offered to end users for free. Category II vaccines are paid for by customers or their insurers, which creates a market composed of China’s growing number of health-conscious customers who are both able and willing to pay a premium for high-quality vaccines. China’s vaccine market is dominated by Category II vaccines, and certain categories of vaccines, such as human rabies vaccines, are exclusively offered as Category II vaccines, according to the F&S report. In 2021, Category II vaccine accounted for 94.7% of the total market production value, and is expected to account for 97.9% of the total market production value by 2030, according to the same source.

China's Vaccine Market Production Value, Breakdown by Vaccine Types, 2017-2030E

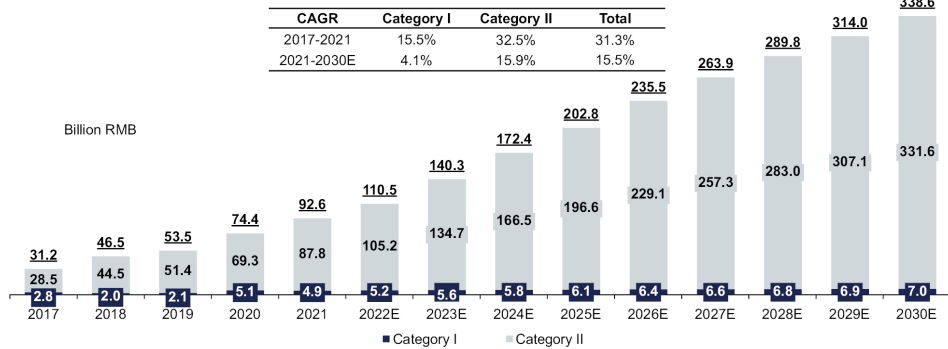

Note: the China market size is production value based and forecasted based on 2021 lot release data. COVID-19 vaccine market is currently not taken into consideration. The historical data is gathered from NIFDC of China which is highly regulatorily driven and depends on the policy enacted by the government and working efficiency of NIFDC in those years. The forecasted data is made based the assumption that the working efficiency of NIFDC would not greatly fluctuate in the future while the market is continuously driven by the current unmet need in the vaccine industry of China.

Source: Expert interview, NIFDC, Frost & Sullivan analysis

With respect to Category II vaccines, manufacturers generally must win bids in public tender process of the relevant province-level CDCs, which give them qualification to access the provincial market. Manufacturers are then required to make direct sales to, and settle payment with, county-level CDCs. The only exception is the Beijing CDC, who purchase Category II vaccines from manufacturers through its public tender process and allocate to county-level CDCs under its administration. With respect to Category I vaccines, province-level CDCs purchase vaccines through centralized bidding process and allocate to county-level CDCs, which in turn allocate to vaccine locations on an as-needed basis. Vaccine manufacturers may directly distribute Category I vaccines to province-level CDCs or county-level CDCs. County-level CDCs may distribute both Category I and II vaccines to healthcare providers.

After Revision of Vaccine Distribution Regulation

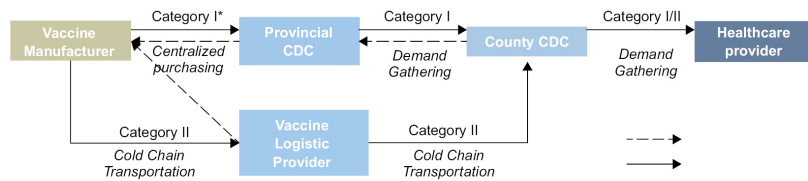

**Note: Vaccine manufactures should supply the category I vaccines to provincial CDCs or other CDCs based on the agreement of the government procurement contract.*
Source: Frost & Sullivan analysis

According to the NIFDC and the F&S report, rabies vaccines rank first among all vaccine categories in China in terms of lot release quantity in 2021.

The following table sets forth the top 10 types of vaccines ranked by the number of lot release in China in 2021.

Top 10 Types of Vaccines Ranked by Number of Lot Release in China in 2021

Rank	Vaccine	Number of Lot release
1	Rabies Vaccine	983
2	Hepatitis B Vaccine	565
3	Meningitis Vaccine	563
4	Flu Vaccine (Including HIB)	553
5	Varicella Vaccine	471
6	Polio Vaccine	339
7	MMR Vaccine	281
8	HPV Vaccine	254
9	Japanese Encephalitis Vaccine	224
10	DPT Vaccine	203

Note: COVID-19 vaccines are not included.

Source: Frost & Sullivan analysis

Growth drivers of China's vaccine market

The major growth drivers of China's vaccine market, in particular with respect to Category II vaccines, include:

- *Increasing health awareness coupled with better affordability.* Economic opening up and growth, together with the improvement in education level and life quality in China have equipped Chinese people with a higher level of health-oriented knowledge and awareness, including the importance of vaccination. The increase in disposable income of Chinese people also leads to higher expenditure in managing their health, enhancing the demand for Category II vaccines which depend less on government reimbursement.
- *Supply of vaccines short of demand.* As a result of the Changchun Changsheng vaccine scandal in July 2018, the number of vaccine lot release in 2018 dropped significantly, causing a significant and prolonged impact on the supply of Category II vaccines in China. Although the vaccine market has begun to recover, the demand of vaccine still exceeds supply.
- *Advent of innovative vaccines with lack of effective treatment.* Along with the growing efforts in the research and development of innovative vaccines, more next-generation Category II vaccines for diseases such as rabies, malaria, HPV, tuberculosis are likely to debut, accompanied by improved product quality such as better protection and cost savings. Moreover, for many infectious diseases, such as rabies, no effective treatments are available, which makes vaccination the only method to reduce the harmful consequences and drives sustainable market demand.
- *Favorable government policies.* Given the importance of vaccination to public health in containing infections, the Chinese government has issued multiple policies to ramp up the capabilities to develop vaccines domestically and promote immunization program, all of which will drive the expansion of the vaccine market.

Entry barriers of China's vaccine market

The major entry barriers of China's vaccine market include:

- *Difficulties in the R&D of innovative vaccines.* Not all participants in the human vaccination industry are able to engage in each key step towards market success in the vaccine industry, consisting of research and development, manufacture and commercialization. In particular, the research and development of innovative vaccines involves a long-term process with substantial risk of failure and requiring significant capital investments, scientific and technological expertise, and human resources.

[Table of Contents](#)

- *Stringent regulations of vaccine manufacture.* Vaccine manufacture is under stringent regulation in China to safeguard the quality and safety of vaccine products. Regulatory measures include compulsory inspection and review of each lot of vaccine products and on-site verification and sampling, setting high barrier for potential new entrants.
- *Establishment of sales and marketing channels.* The vaccine distribution channels involve multiple parties, such as county-level CDCs and service providers, with which manufacturers must form stable relationship to maintain and expand their sales and marketing channels. Potential new entrants may not be able to compete with existing main market players due to the significant efforts involved in forming such relationship.

Human rabies vaccines market

Overview

Rabies is a vaccine-preventable viral zoonotic disease primarily caused by the transmission of rabies virus to humans via infected animals, including primarily pet dogs. Rabies occurs in more than 150 countries and territories and accounts for an estimate of 59,000 human deaths in 2015, with over 95% human deaths occurring in developing countries in Asia and Africa, according to the F&S report. The mortality rate of rabies is nearly 100% post exposure without the administration of post-exposure prophylaxis (“PEP”), which makes human rabies vaccine essential for the prevention of rabies, according to the same source. PEP must be applied using appropriate vaccine regimens and administration routes of proven safety and effectiveness. Generally, grade II exposure to rabies virus, which involves nibbling of uncovered skin, minor scratches or abrasions without bleeding, requires immediate vaccination. Grade III exposure, which involves more serious exposure such as single or multiple transdermal bites or scratches and contamination of mucous membrane or broken skin with saliva from animal licks, calls for both immediate vaccination and administration of rabies immunoglobulin.

Unlike the developed countries in which vaccination for pets is the main method to control rabies, immediate PEP for human is the most effective method to control the death toll of rabies in less developed countries and regions with high bite incidence and mortality, according to the F&S report. The median bidding price of rabies vaccine under Vero cell line per dose has increased steadily in China in the past three years, growing from RMB53.0 in 2017 to RMB70.0 in 2020, and further to RMB87.0 in 2021, according to the F&S report.

Median Bidding Price of Rabies Vaccine (Vero Cell) Per Dose in China, 2017-2021

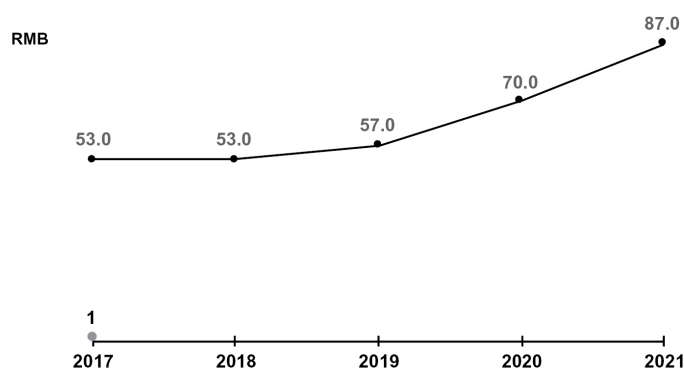

China's rabies vaccine market production increased from RMB4.5 billion in 2017 to RMB9.4 billion in 2021, at a CAGR of 23.8%, and is expected to reach RMB22.1 billion in 2025, at a CAGR of 23.8% from 2021 to 2025. The following table sets forth the future trend of China's rabies vaccine market production value.

China's Rabies Vaccine Market Production Value, 2017 — 2030E

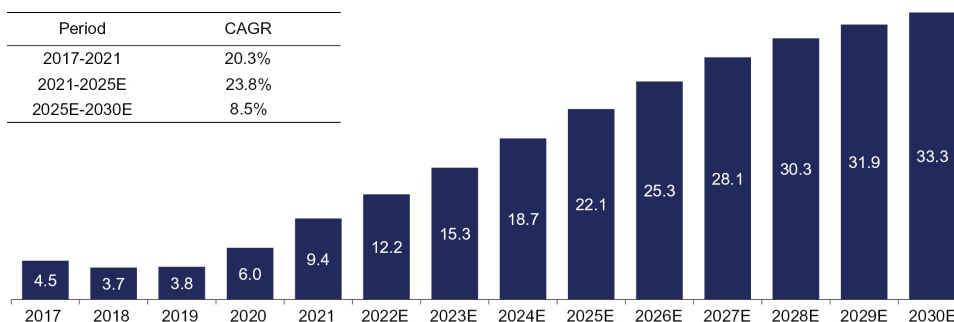

Source: Expert interview, Frost & Sullivan analysis

There are two regimens for rabies in China, i.e., Essen five-dose regimen and Zagreb 2-1-1 regimen.

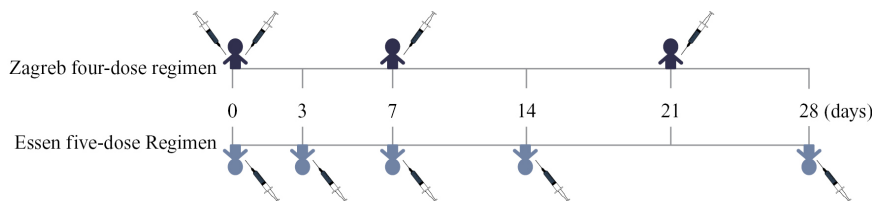

Source: Frost & Sullivan analysis

Starting from July 2018, China Food and Drug Administration (“CFDA”), now known as the National Medical Products Administration, carried out a series of inspections on Changchun Changsheng, which revealed that the company had been blending different lots of vaccine fluid, falsifying production date, using expired fluid in batch production and forging permits. Changchun Changsheng’s illegal production of rabies vaccine led to the CFDA’s measures to strengthen relevant regulations, including the comprehensive inspection on all vaccines in China covering the entire supply chain comprising raw material procurement, manufacturing, and the signing and issuance of lot release. China’s human rabies vaccine market production value is expected to increase from RMB9.4 billion in 2021 to RMB22.1 billion in 2025, at a CAGR of 23.8%, and is expected to reach RMB33.3 billion in 2030, at a CAGR of 8.5% from 2025 to 2030, according to the F&S report. The expected growth rates of China’s rabies vaccine production value are based on several assumptions, including: (1) the expected increase in vaccination rate, (2) the introduction of more high-value rabies vaccines, and (3) the expected penetration rate of rabies vaccine which is estimated to reach 75% in 2030 and will remain well below 100% in the foreseeable future.

The current estimation of China’s rabies vaccine market takes into account multiple factors, such as the status quo of the current market, including (1) the increase in China’s pet dog population and the low veterinary vaccination rate, which has led to a large stray dog population with a low immunity rate, (2) the particular low penetration rate of veterinary rabies vaccine in China’s rural areas due to limited funding, which fails to establish epidemic prevention, and (3) the lack of established surveillance system for rabies-carrying animals in China. This estimation also takes into account new initiatives that may impact the future market, such as the revised animal epidemic prevention law. In particular, the revised animal immunization law may have the following impacts on the expected market production value of rabies vaccine in China in light of the status quo. The complete elimination of rabies in China may take years and the demand for human rabies vaccine is likely to sustain according to the F&S report. For instance, while Mexico adopted the national initiative to control and eliminate rabies in the 1990s, which included comprehensive measures such as mass vaccination for dogs, continuous and effective surveillance programs and mass availability of PEP in its public health services, it did not obtain WHO validation for eliminating human rabies transmitted by dogs until 2019. The currently marketed rabies vaccine for animal use in China can only provide protection of 12 to 36 months and mandate subsequent vaccination. Additionally, it is difficult to identify animals infected with rabies, which implies

the difficulty of eradication of rabies solely through animal vaccination. Moreover, given the high fatality upon rabies infection, it is expected that people may still opt to be administered with rabies vaccines after being bitten by vaccinated pets, which may drive a continuous demand for human rabies vaccine in China. In addition, the prevention of rabies in rural areas in China still requires human rabies vaccines, considering the insufficient resources to implement effective veterinary prevention system and the large geographic scope.

The number of people bitten by dogs and other rabies-carrying animals in China in 2021 was approximately 49 million, and that number is expected to increase to 52 million in 2025 and 55 million in 2030. The penetration rate of rabies vaccine was 40.6% in 2021, and is expected to increase to 65.7% in 2025 and 75.5% in 2030. The following table sets forth the future trend of China’s number of new bites and penetration of the rabies vaccine.

China Number of New Bites and Penetration of Rabies Vaccine in 2021, 2025E, and 2030E

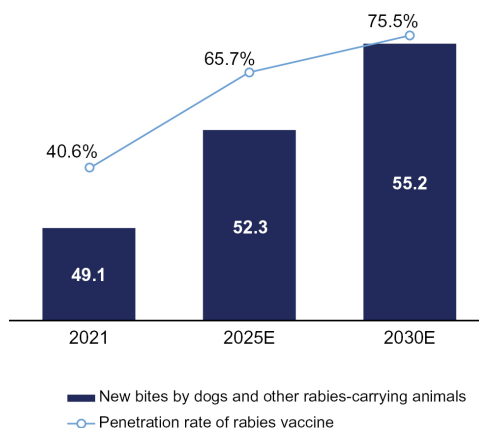

Note: The penetration rate is calculated by dividing the lot release quantity of human rabies vaccine by estimated total number of rabies vaccines required theoretically.

Source: Expert interview, NIFDC, Frost & Sullivan analysis

The following table sets forth the market size of China’s rabies vaccine market in terms of lot release, according to the F&S report.

Year	2012	2013	2014	2015	2016	2017	2018	2019	2020	2021
Lot release (in million doses)	126.2	73.3	58.8	77.8	58.9	78.2	62.9	58.8	78.6	88.0

Source: NIFDC, Frost & Sullivan analysis

The human rabies vaccine market can be further divided according to the different cell lines used in manufacturing. According to the F&S report, rabies vaccine under the Vero cell-line accounted for approximately 88.8% of the total lot release in China in 2021, compared with that of 5.8% and 5.4% for primarily hamster kidney cell (“PHKC”) line and human diploid cell line, respectively. Vero cells are expected to continue to be the mainstream cell line to produce human rabies vaccines in the near future, according to the F&S report. Vero cells have advantages over human diploid cells and PHKC in the evaluation of the efficiency of cell culture. The risk of exogenous contamination during production from Vero cells in a bioreactor is also lower than that of PHKC. In addition, it is difficult to scale up production with human diploid cells due to the associated high technical standards. Furthermore, according to the F&S report and as revealed in several studies, the effect of rabies vaccines based on Vero cells is comparable to that of the vaccines based on the more expensive human diploid cells.

Growth drivers and future trends of China's rabies vaccine market

The primary growth drivers and future trends of China's rabies vaccine market include:

- *High demand for human rabies vaccines.* The pet dog population in China has grown rapidly in the past few years, increasing from approximately 87 million in 2017 to approximately 100 million in 2021, according to the F&S report. With China's societal development and demographic changes, the number of pet dogs is likely to continue growing. Moreover, the number of stray dogs may continue to grow due to underregulated pet abandonment. However, the penetration rate of human rabies vaccine in China is still low.
- *Insufficient supply of human rabies vaccines.* New regulations in China have imposed stringent standards on human rabies vaccines, such as virus cultivation and purification and the environment of manufacturing facilities, which eliminates those suppliers unable to upgrade their product line and technologies. The expiration date of rabies vaccines is relatively short, which could further lower the supply.
- *Lack of animal vaccination.* The increase in both pet dog and stray dog population, coupled with the absence of effective animal vaccination programs in developing countries such as China, makes people more susceptible to bites by infected animals. Therefore, the demand for human rabies vaccine will continue to increase and drive the growth in sales volume and revenue.
- *Broader overseas market.* Given the continuous efforts to promote rabies vaccination in those countries and regions where people still have relatively low awareness of rabies vaccination, the vaccination rates in those markets have the potential to increase in the future, which will present more opportunities for vaccine companies in China to expand overseas. Moreover, due to the serious lack of human rabies vaccine manufacturers in those markets with high incidence of rabies, Chinese rabies vaccine manufacturers have the opportunity to capture the increasing demand underserved by the local suppliers in those markets, which will drive the growth of the export market.
- *Advancement in user-friendly options.* According to the WHO, the current recommended PEP regimens against rabies infection are the Essen and the Zagreb schedule, and WHO has a task that prioritizes the reduction of the duration and number of doses administered under those regimens. As such, more user-friendly rabies vaccines featuring shorter duration and smaller number of doses are likely to lead the future development of rabies vaccines.
- *Growing demand from people with immunocompromised conditions.* There is a growing population with immunocompromised conditions such as those caused by or associated with chronic diseases, medical treatment, transplants, smoking, obesity and aging. Such population is likely to have inadequate antibody responses to the current rabies vaccines, which necessitates the development of novel, appropriate vaccines.

Competitive landscape of China's rabies vaccine market

According to the NMPA and the F&S report, there were 15 marketed human rabies vaccine products in China as of July 31, 2022. China's human rabies vaccine market is highly concentrated, with the top four manufacturers, including Chengda Biotechnology, Rongan Biological Products, Changchun Zhuoyi, and YS Group, representing a combined market share of 82.7% in terms of lot release in 2021. YS Group started to sell YSJA™ rabies vaccines in October 2020, representing 3.2% of China's rabies vaccine market in terms of lot release in the full year of 2020. Its vaccine sales increased to 8.1% in terms of lot release and 7.2% in terms of production value in the calendar year 2021. According to the CDE and the F&S report, there were nine human rabies vaccine candidates in China as of December 31, 2021. The following table sets forth the marketed human rabies vaccines based on Vero cell technology in China according to the 2021 lot release results.

[Table of Contents](#)

Company	Products	Cell line	Specifications	Dose regimen	Median bidding price (unit: RMB)
YS Biopharma	Freeze-dried Human Rabies Vaccine	Vero cell	0.5ml per dose after reconstitution	Essen five-dose	95.0
Chengda Biotechnology	Freeze-dried Human Rabies Vaccine/Human Rabies Vaccine	Vero cell	0.5ml per dose after reconstitution	Zagreb four-dose & Essen five-dose	104.0
Rongan Biological Products	Freeze-dried Human Rabies Vaccine	Vero cell	1.0ml per dose after reconstitution	Essen five-dose	81.9
Chengdu Kanghua Biological Products	Freeze-dried Human Rabies Vaccine	Human diploid cell	1.0ml per dose after reconstitution	Essen five-dose	310.0
Zhongke Biopharma	Human Rabies Vaccine	PHKC	1.0ml per dose	Essen five-dose	95.0
Yuanda Biopharma	Human Rabies Vaccine	PHKC	1.0ml per dose	Essen five-dose	79.0
Changchun Zhuoyi	Freeze-dried Human Rabies Vaccine	Vero cell	0.5ml per dose after reconstitution	Essen five-dose	87.0
Aleph Bio	Human Rabies Vaccine	Vero cell	1.0ml per dose	Essen five-dose	83.0
Changchun Institute of Biological Products	Freeze-dried Human Rabies Vaccine	Vero cell	0.5ml per dose after reconstitution	Zagreb four-dose & Essen five-dose	94.5

Source: NMPA, Frost & Sullivan analysis

Human Rabies Vaccine Market in Select Southeast Asian Countries

According to the F&S report and expert interviews, the aggregate market size of rabies vaccine in the Philippines, Vietnam, Malaysia and Singapore in terms of sales revenue increased from \$6.4 million in 2017 to \$18.1 million in 2021, at a CAGR 29.5%, and is expected to increase to \$45.0 million in 2025, at a CAGR of 25.6% from 2021 to 2025, and further to \$89.9 million in 2030, at a CAGR of 14.8% from 2025 to 2030. The following table sets forth the marketed rabies vaccines based on Vero cell technology in those countries as of July 31, 2022.

Rabies Vaccine Approved in Singapore

Product Name	Company	Cell Type
Verorab®	Sanofi	Vero cell
Rabipur®	Novartis	Purified chick embryo cell

Rabies Vaccine Approved in Malaysia

Product Name	Company	Cell Type
Verorab®	Sanofi	Vero cell

Rabies Vaccine Approved in Vietnam

Product Name	Company	Cell Type
Verorab®	Sanofi	Vero cell
Rabipur®	Novartis	Purified chick embryo cell
Indirab®	Bharat Biotech	Vero cell
Speeda®	Liaoning Chengda	Vero cell

Note: As of July 31, 2022

Source: Government website. Frost & Sullivan analysis

Rabies Vaccine Approved in Philippine

Product Name	Company	Cell Type
Rabivax-S®	Serum Institute of India	Vero cell
Verorab®	Sanofi	Vero cell
Rabipur®	Novartis	Purified chick embryo cell
Abhayrab®	Indian Immunologicals	Vero cell
Indirab®	Bharat Biotech	Vero cell
Speeda®	Liaoning Chengda	Vero cell
Vaxirab N®	Cadila Healthcare	Purified chick embryo cell
Bioshoot®	Changchun Zhuoyi	Vero cell

Note: As of July 31, 2022

Source: Government website, Frost & Sullivan analysis

According to the F&S report, dog bites are common in Southeast Asia, and Southeast Asian countries expend substantial funds on human rabies biologics annually. In Philippines, 815,902 dog-biting cases were reported and 276 victims died of rabies infection in 2018. In Vietnam, more than 350,000 people were bitten by dogs and cats while more than 80 human deaths were reported in 2018. While Singapore is recognized as rabies-free and Malaysia has almost realized rabies-free, rabies vaccine market still exists in those countries. In particular, when faced with the deadly rabies virus, people may still opt to be administered with human rabies vaccines after being bitten by animals to ensure life safety and health. All mammals, including cats and bats, are susceptible to infection with rabies virus, although only a few species are recognized as important for the persistence of the disease and attainment of rabies-free status. In addition, people traveling to other countries with a high risk of rabies infection also need to be vaccinated, which supports the market size of human rabies vaccines.

To compete effectively in the Southeast Asian markets and quickly capture the local demand, YS Group plans to implement its clinical trial plan for rabies vaccines in Southeast Asian countries, construct manufacturing plant in Singapore, and collaborate with local partners for product registration, sales and marketing. See the section entitled “Business — Growth Strategies — Pursue integrated global growth strategy through international collaborations and partnerships.”

Covid-19 Vaccine Market

Overview and impact of COVID-19

COVID-19 is the infectious disease caused by the most recently discovered coronavirus. Coronaviruses are a large family of viruses which may cause illness in animals or humans, which are widely distributed in many different species of animals, including bats, cattle, cats, birds, and camels. They are also one of the pathogens that causes respiratory tract infection in human. According to a study from John Hopkins University and the F&S report, herd immunity of COVID-19 could be achieved when 70% to 90% of the population acquire immunity. Assuming that an individual needs an average of two doses of COVID-19 vaccine to achieve immunity, a corresponding total of 10.5 to 13.5 billion doses and 2.0 to 2.5 billion doses of COVID-19 vaccines are required to achieve herd immunity globally and in China, respectively. The global economy could suffer between \$5.8 trillion and \$8.8 trillion in losses, equivalent to 6.4% to 9.7% of global GDP, as a result of the COVID-19 pandemic.

According to the F&S report, COVID-19 could co-exist with humans for a long period of time because it is more adaptive to the host and less virulent than other viruses such as Severe Acute Respiratory Syndrome (“SARS”). To lower the mortality of COVID-19 patients, the government around the globe are willing to procure and/or reimburse for COVID-19 vaccines. In addition, COVID-19 might significantly change people’s attitude towards infectious diseases, leading to the increase in the detection rate of infectious diseases and driving the growth of vaccines and other anti-infective drugs. According to the Technical Guideline for the Research and Development of COVID-19 Prophylactic Vaccine (Tentative) issued by the CDE in August 2020, in response to the COVID-19 pandemic, on condition that the safety of participants could be protected, a flexible trial design under which as much information and data as possible is obtained may be adopted to shorten the clinical trial period and accelerate the clinical research process. COVID-19 vaccines will be offered for free for Chinese residents, the cost of which will be covered by the government’s fund. Vaccine manufacturers may price their product based on the cost of production and product attributes. Relevant government departments will follow the corresponding procurement procedures to purchase from vaccine manufacturers.

Challenges and future trends of COVID-19 vaccine market

There are certain challenges associated with the development of COVID-19 vaccines. First, early phase clinical trials on COVID-19 vaccines rely on antibody titers to test immunogenicity, which is not a conclusive indicator for vaccine efficacy. Large-scale Phase III trials are the only way to prove effective protection. Second, the manufacturing of COVID-19 vaccines involves unproven technology platforms and extra capacity, which increased the related manufacturing risks. Third, simulation experiments have revealed that to prevent an epidemic, the efficacy of a vaccine must be at least 60% when vaccination coverage is 100%. However, the adoption of COVID-19 vaccine is still at a relatively nascent stage.

There are a few trends associated with the future development and the market of COVID-19, according to the F&S report. First, the potential of different types of COVID-19 vaccines based on diverse technology, such as mRNA-based, DNA-based and protein-based vaccines could be further explored. Second, vaccines of improved efficacy and safety might be developed and launched. Future COVID-19 vaccines might be optimally designed to maximize immunogenicity and exclude unnecessary or even harmful protein domains. In addition, more accurate measurement of the efficacy might be developed to align with the advancement in efficacy. Vaccines suitable for immunocompromised people and/or providing long-term safety will continue to be discovered and developed. Furthermore, it remains unclear whether the vaccines developed so far are able to prevent people from acquiring mild infections that could be passed on to others, and the duration of immunity to COVID-19 rendered by vaccines.

Competitive landscape of global COVID-19 vaccine market

According to the WHO and the F&S report, there were a total of 70 COVID-19 vaccine products and product candidates in clinical Phase III and above as of July 31, 2022. The following table sets forth the current primary COVID-19 vaccine products.

COVID-19 Vaccine developer/manufacturer	Vaccine platform	Type of candidate vaccine	Status / Clinical Phase ¹	Doses ²
Moderna/NIAID	RNA	LNP-encapsulated mRNA	FDA approval/WHO issued emergency use listing	2
BioNTech/Fosun Pharma/Pfizer	RNA	3 LNP-mRNAs	FDA approval/WHO issued emergency use listing	2
Beijing Institute of Biological Products/Sinopharm	Inactivated	Inactivated	NMPA conditional approval/WHO issued emergency use listing	2
University of Oxford/AstraZeneca	Non-Replicating Viral Vector	ChAdOx1-S	WHO issued emergency use listing	2
Sinovac	Inactivated	Inactivated	NMPA conditional approval/WHO issued emergency use listing	2
CanSino/Beijing Institute of Biotechnology	Non-Replicating Viral Vector	Adenovirus Type 5 Vector	NMPA conditional approval/WHO issued emergency use listing	1
Wuhan Institute of Biological Products/Sinopharm	Inactivated	Inactivated	NMPA conditional approval	2
Janssen Pharmaceutical	Non-Replicating Viral Vector	Ad26.COV2.S	FDA issued an emergency use authorization/WHO issued emergency use listing	1
Anhui Zhifei Longcom	Protein Subunit	Protein Subunit	NMPA conditional approval	3
Shenzhen Kangtai Biological	Inactivated	Inactivated	NMPA conditional approval	3
Serum Institute of India (Novavax formulation)	Protein Subunit	Protein Subunit	WHO issued emergency use listing	2
Novavax	Protein Subunit	Protein Subunit	FDA issued an emergency use authorization/WHO issued emergency use listing	2
Serum Institute of India (Oxford/AstraZeneca formulation)	Non-Replicating Viral Vector	ChAdOx1-S	WHO issued emergency use listing	2
Bharat Biotech	Inactivated	Inactivated	WHO issued emergency use listing	2

Note: COVID-19 vaccine, in China approved for emergency use are not included.

[Table of Contents](#)

1. Only FDA, NMPA and WHO issued vaccine approval is displayed.
2. Doses required for each product in clinical phase are based on the clinical information exhibited in public sources. As of July 31, 2022

Source: WHO, Clinicaltrials.gov, Frost & Sullivan analysis

Immuno-Oncology Market

Overview

Immuno-oncology therapy is designed to stimulate the patient's own immune system to generate or augment an antitumor immune response to control or eradicate cancer cells. Due to its ability to provide durable remissions while being generally well-tolerated in certain patients with advanced cancers, immuno-oncology therapy marks a milestone in cancer treatment in recent years. Major types of immuno-oncology therapies include cellular immunotherapies, checkpoint inhibitors, therapeutic cancer vaccines and cytokines.

China's immuno-oncology therapies market has grown substantially in recent years, and the momentum is expected to continue to grow. According to the F&S report, China's immuno-oncology therapies market grew from RMB0.9 billion in 2017 to RMB16.3 billion in 2021, at a CAGR of 108.2%, and is expected to grow to RMB63.8 billion in 2025, at a CAGR of 40.6% from 2021 to 2025, and further to RMB256.4 billion, at a CAGR of 32.1% from 2025 to 2030.

Due to factors such as alcohol abuse, HBV and hepatitis C virus infections, the incidence of hepatocellular cancer in China increased from approximately 351,100 in 2017 to 388,000 in 2021, at a CAGR of 2.5%, and is expected to reach approximately 427,500 in 2025, at a CAGR of 2.5% from 2021 to 2025 and 474,200 in 2030, at a CAGR of 2.1% from 2025 to 2030, according to the F&S report. The hepatocellular drug market, in terms of sales revenue, increased from RMB3.6 billion in 2017 to RMB8.9 billion in 2021, at a CAGR of 25.4%, and is expected to reach RMB23.8 billion in 2025, at a CAGR of 27.9% from 2021 to 2025 and RMB43.1 billion in 2030, at a CAGR of 12.6% from 2025 to 2030, according to expert interviews and the F&S report. The incidence of pancreatic cancer in China increased from approximately 101,500 in 2017 to approximately 115,900 in 2021, at a CAGR of 3.4%, and is expected to reach approximately 133,100 in 2025, at a CAGR of 3.5% from 2021 to 2025 and 155,800 in 2030, at a CAGR of 3.2% from 2025 to 2030. The pancreatic cancer drug market, in terms of sales revenue, increased from RMB2.4 billion in 2017 to RMB3.0 billion in 2021, at a CAGR of 6.5%, and is expected to reach RMB7.0 billion in 2025, at a CAGR of 23.1% between 2021 to 2025 and RMB11.8 billion in 2030, at a CAGR of 11.1% between 2025 to 2030, according to the same source.

Growth Drivers of China's Immuno-Oncology Market

The primary market drivers of China's immuno-oncology market include:

- *Unmet clinical demand of cancer patients.* Due to the rapid increase in the incidence of cancer and limitations of existing treatments, there is significant unmet demand of cancer patients for immuno-oncology therapies. Although a number of immunosuppressant and chimeric antigen receptor T-cell (CAR-T). CAR-T products have been approved successively, there are still problems associated with such products, which calls for the continuous development of safe and more effective therapies.
- *Expansion of indications.* Although there have been six PD-1 monoclonal antibodies (mAbs) launched in China, only eight indications have been approved by the end of 2020. By the end of 2020, the U.S. FDA had approved 19 indications for PD-1 mAbs, which suggests great potential of the expansion of indications in China and thus the development of the immune-oncology market.
- *Rapid development of new-generation therapies.* Benefiting from the regulatory approval of CTLA-4 inhibitor in 2011, the development of immuno-oncology therapeutics has experienced significant progress. Immuno-oncology has become a sub-specialty under oncology due to its unique scientific nature and its potential for substantial, long-term clinical advantages. Since immunotherapy agents mobilizes the immune system, immuno-oncology drug may encompass a broad range of agents with great potential.

Table of Contents

- *Favorable policies.* Chinese government is implementing favorable policies to promote the development of new immune-oncology therapies. Special review channels also accelerate the marketing of anti-tumor drugs with outstanding therapeutic advantages in China. In addition, policies such as the expansion of medical insurance, zero tariff on imported anticancer drugs, and coverage of anticancer drugs under NRDL will reduce the cost of anticancer drugs, which will drive the growth of China's immune-oncology market.

Competitive Landscape of the Immuno-oncology Therapeutics Targeting TLR3/MDA5/RIG-I

According to the F&S report, there are six immune-oncology therapeutics targeting TLR3/MDA5/RIG-I under development globally as of July 31, 2022, and there is no such therapeutic under development in China. The following table sets forth the pipeline information of the candidates.

Product ¹	Drug Type	Company	Phase	Target	Indications ²	Trial Sites	First Posted Date
Hiltonol/Poly-ICLC	Double stranded RNA complex	Oncovir	II	TLR3/MDA5	AML, Astrocytoma, Breast Cancer, Bladder Cancer, BT, CC, CIN, CMML, CNS Tumor, CRC, FLC, FL-HCCFTC, Glioma, HNCKC, Low-Grade B-cell Lymphoma, MCC, MDS, MPM, NHL, NMSC, NSCLC, OC, Oligo-Astrocytoma, Pancreatic Cancer, Prostate Cancer, PPC, RC, Sarcoma, OCSCC, SMM, TC, UC, Myelofibrosis, Melanoma	Canada, US, UK, Spain, Russian, Hungary, Ukraine, Germany, Switzerland, Netherlands, Denmark,	2015/1/8
Ampligen/Rintatolimod	RNA	AIM ImmunoTech	II	TLR-3	BC, OC, Prostate Cancer	US	2019/4/2
BO-112	Synthetic dsRNA complex	Highlight Therapeutics	II	TLR3/MDA5/RIG-I	CRC, Melanoma, GC, Oesophageal Cancer	Spain, Belgium, Italy	2020/8/11
CV-8102	RNA-based adjuvant	CureVac	I/II	TLR7/8RIG-1	HCC, Melanoma, SCC of the Skin Carcinoma, HNSCC, Adenoid Cystic	Austrial, France, Germany, Spain, UK	2017/6/29
EG-70	non-viral gene therapy encoding RIG-I agonists	enGene	I/II	RIG-I	Bladder cancer	US	2021/2/12
YS-ON-001	Multiple component complex of proteins	YS Biopharma	I	TLR3/MDA5/RIG-I	Cancer	Singapore	2017/4/27

Note: Pipeline information as of July 31, 2022. Only systemic drugs for the treatment of cancer.

AML=Acute Myeloid Leukemia, CC=Colon Cancer, CIN=Cervical Intraepithelial Neoplasia, CMML=Chronic Myelomonocytic Leukemia, CRC=Colorectal Cancer, FL-HCC=Fibrolamellar Hepatocellular Carcinoma, FTC=Fallopian Tube Carcinoma, GC=Gastric Cancer, HCC=Hepatocellular Carcinoma, HNC=Head and Neck Cancer, HNSCC=Head and Neck Squamous Cell Carcinoma, KC=Kidney Cancer, MCC=Merkel Cell Carcinoma, MDS=Myelodysplastic Syndrome, MPM=Malignant Pleural Mesothelioma, NHL=Non-Hodgkin's Lymphoma, NMSC=Non-Melanoma Skin Cancers, OC=Ovarian Cancer, OCSCC=Oral Cavity Squamous Cell Carcinoma, PPC=Primary Peritoneal Carcinoma, RC=Renal Cancer, SCC=Squamous Cell Carcinoma, SMM=Smoldering Multiple Myeloma, TC=Testicular Cancer, UC=Urothelial Cancer

Source: Clinicaltrials.gov, Frost & Sullivan analysis

Hepatitis B Vaccines Market

Overview

Hepatitis B is an infectious disease caused by hepatitis B virus ("HBV") and characterized by inflammation of the liver. HBV infections may be acute, short-term or chronic, with children infected with HBV prone to chronic hepatitis. Chronic HBV can cause serious health issues, such as cirrhosis, liver failure, liver cancer, or hepatocellular cancer. According to the F&S report, the diagnosis and treatment rate in China is relatively low at 32.1% and 21.1% in 2019, respectively, mainly due to low public awareness of the disease, massive patients pool and lack of diagnosis capacity in remote areas. Lot release of hepatitis B prophylactic vaccine has reached 70.7 million in 2021, at a CAGR of -3.3%, and is expected to reach 85.4 million in 2025, at a CAGR of 4.9% from 2021 to 2025, and further to 90.8 million in 2030 at a CAGR of 1.2% from 2025 to 2030, according to the same source.

There are mainly four categories of HBV antiviral drugs in China, recombinant cytokine gene-derived protein, polypeptide, nucleoside analogue and interferon, none of which is individually sufficient to achieve functional cure of HBV and cannot meet the medical needs for HBV therapies. While prophylactic vaccines are ineffective in treating infected HBV patients, there is an emerging pipeline of therapeutic vaccine candidates for treating chronic HBV based on different platforms, which have the potential to enhance the efficacy of current antiviral therapies through strong adaptive and innate immune responses.

Growth drivers of China's hepatitis B prophylactic vaccine market

The primary growth drivers of China's hepatitis B prophylactic vaccine market include:

- *Favorable government policies for hepatitis B prophylactic vaccines.* Due to the large population base, the deep pool of existing infected patients, and the low penetration of diagnosis and treatment, China has the heaviest hepatitis B infection burden in the world and still faces considerable challenges to meet the WHO's target to eliminate viral hepatitis as a major public health threat by 2030. Therefore, spreading vaccination among newborns is still an important domestic agenda with the support of government funds.
- *Demand from non-responders to previous vaccines.* A hepatitis B vaccine non-responder refers to one who does not develop protective surface antibodies after completing two full series of the vaccine and for whom an acute or chronic hepatitis B infection has been eliminated. Approximately five to 15 percent of the population may be non-responders due to aging, obesity, smoking, and other chronic illness, which requires the development of vaccines to protect such group.
- *Simplified vaccination and better efficacy.* The conventional hepatitis B vaccines are administered in three doses, failure of which may reduce effectiveness. A two-dose regimen has the potential to improve adherence and also provide greater seroprotection, which simplifies the vaccination regimen and improves efficacy.

Growth drivers of China's HBV treatment market

The primary growth drivers of China's HBV treatment market include:

- *Improving diagnosis and treatment rate.* The rapid increase in healthcare spending in China has led to significant improvement in the primary medical institutions' diagnosis capacity and diagnosis rate of HBV patients in rural area. With the increasing public awareness of HBV, more patients are likely to seek treatment, which drives the market growth.
- *Government support.* All marketed hepatitis B antiviral drugs in China had entered the National Reimbursement Drug List as of December 31, 2020, which will markedly improve the penetration of such drugs in China. Moreover, Chinese government is making significant efforts to achieve functional cure of HBV. Therefore, innovative HBV drugs such as therapeutic vaccines are likely to enter the National Reimbursement Drug List and receive large-scale government support.
- *Huge unmet demand for functional cure.* HBV Treatment currently available in China does not affect the transcriptional activity of covalently closed circular DNA or viral protein production and thus cannot afford functional cure. Therefore, there is a significant unmet demand for treatment providing functional cure, which will free HBV patients from taking antiviral drugs and significantly lower the risk of inflicting liver cirrhosis and liver cancer.

Competitive landscape of China's hepatitis B vaccine market

According to the NMPA and the F&S report, there were nine marketed hepatitis B prophylactic vaccine products in China as of July 31, 2022.

Company	Products	Cell line	Specifications	Regimen
Lanzhou Institute of Biological Products	Recombinant Hepatitis B Vaccine	CHO	20µg/1.0ml, 10µg/1.0ml	3-dose schedule (0, 1, 6 months)
Beijing Yadong Biological Pharmacy	Recombinant Hepatitis B Vaccine	CHO	10µg/0.5ml, 20µg/1.0ml	3-dose schedule (0, 1, 6 months)
Wuhan Institute Of Biological Products	Recombinant Hepatitis B Vaccine	CHO	10µg/1.0ml	3-dose schedule (0, 1, 6 months)
North China Pharmaceutical Group	Recombinant Hepatitis B Vaccine	CHO	20µg/1.0ml, 10µg/0.5ml	3-dose schedule (0, 1, 6 months)
Aimei Hissen Vaccine (Dalian)	Recombinant Hepatitis B Vaccine	Hansenula polymorpha	10µg/0.5ml, 20µg/0.5ml	3-dose schedule (0, 1, 6 months)
Shenzhen Kangtai Biological Products	Recombinant Hepatitis B Vaccine	Saccharomyces	60µg/1.0ml, 10µg/0.5ml, 20µg/1.0ml	1-dose on day 0, 3-dose schedule (0, 1, 6 months)
Hualan Biological Vaccines	Recombinant Hepatitis B Vaccine	Hansenula polymorpha	10µg/0.5ml	3-dose schedule (0, 1, 6 months)
Beijing Institute of Biological Products	Recombinant Hepatitis B Vaccine	Saccharomyces	20µg/1.0ml, 10µg/0.5ml	3-dose schedule (0, 1, 6 months)
GSK	Recombinant Hepatitis B Vaccine	Saccharomyces	10µg/0.5ml, 20µg/1.0ml	3-dose schedule (0, 1, 6 months) or 4-dose schedule (0, 1, 2, 12 months)

Source: NMPA, Frost & Sullivan analysis

According to the CDE and the F&S report, there are five hepatitis B prophylactic vaccine pipelines in China as of July 31, 2022. The following table sets forth the current primary candidates in China.

	Company	Cell line	Phase	Specifications	Dose regimen	First Posted Date
Recombinant Hepatitis B Vaccine	Hualan Biological Vaccines	Hansenula polymorpha	III	10µg/0.5ml	3-dose schedule (0, 1, 6 months), newborns should be injected within 24 hours	2014-01-10
				20µg/1.0ml	3-dose schedule (0, 1, 6 months)	2014-09-05
Recombinant Hepatitis B Vaccine	Walvax Biotechnology	Hansenula polymorpha	III	20µg/0.5ml	3-dose schedule (0, 1, 6 months)	2014-04-03
Recombinant Hepatitis B Vaccine	Beijing Minhai Biotechnology	Hansenula polymorpha	I	20µg/1.0ml	NA	2013-09-18
Recombinant Hepatitis B Vaccine	Chengdu Institute Of Biological Products	Pichia pastoris	I	10µg/0.5ml 20µg/1.0ml	3-dose schedule (0, 1, 6 months)	2016-10-17
Recombinant Hepatitis B Vaccine	Sinovac Research & Development	Hansenula polymorpha	I	10µg/0.5ml	3-dose schedule (0, 1, 6 months)	2019-17-02
				20µg/1.0ml	3-dose schedule (0, 1, 6 months)	2020-01-08

Source: CDE, Frost & Sullivan analysis

[Table of Contents](#)

According to the CDE and F&S report, there were six HBV therapeutic vaccine candidates in China as of July 31, 2022, as set forth in the following table.

Competitive landscape of therapeutic vaccines for HBV in China				
Vaccine Name	Company	First Posted Date	Phase	Platform
Therapeutic Hepatitis B Vaccine (YIC)	Beijing Institute of Biological Products	2014-05-07	III	Antigen-antibody complex
Therapeutic Hepatitis B Vaccine (synthetic peptide vaccine)	Jiangsu Mendel Gene Technology	2021-04-14	III	synthetic peptide
Therapeutic dual-plasmid HBV DNA Vaccine	Guangzhou Baidi Biology Medical Company	2017-09-29	IIb	DNA
T101 (TG1050)	Tasly Biopharma	2019-12-02	II	Live vector (Ad5)
BRII-179 (VBI-2601)	Brii Biosciences	2020-04-21	Ib/IIa	Protein
TVAX-008	Jiangsu Theravac Biopharmaceutical	2020-12-24	I	Protein

Note: As of July 31, 2022, according to literature analysis, the development of HBV therapeutic vaccine was still in progress. There is no HBV therapeutic vaccine on the market in China.

Source: CDE, Frost & Sullivan analysis

There were no HBV therapeutic vaccine products approved in China as of July 31, 2022, according to the F&S report. HBV therapeutic vaccine is expected to appear on China's market in 2024, and with such, China HBV therapeutic vaccine market is expected to be RMB1.2 billion in 2024 and increase to RMB23.2 billion in 2030, at CAGR of 63.1% from 2024 to 2030, according to the F&S report.

Source of Information

This section includes information from the F&S report, a report commissioned by YS Biopharma, as it believes such information imparts a greater understanding of the industry. Frost & Sullivan is a global consulting company and an independent third party founded in 1961. Figures and statistics provided in this prospectus and attributed to Frost & Sullivan or the F&S report have been extracted from the F&S report and published with the consent of Frost & Sullivan.

In preparing the F&S report, Frost & Sullivan conducted detailed primary research which involved conducting interviews with industry insiders including leading industry participants and industry experts, and secondary research which involved reviewing company reports, independent research reports and data based on Frost & Sullivan's own research database. Frost & Sullivan also assumed that (1) China's economy is likely to maintain its steady growth in the next decade, (2) China's social, economic, and political environment are likely to remain stable in the forecast period, and (3) relevant market drivers are expected to drive the growth of relevant markets in the forecast period.

BUSINESS

Overview

YS Group is a global biopharmaceutical company dedicated to discovering, developing, manufacturing and commercializing new generations of vaccines and therapeutic biologics for infectious diseases and cancer.

YS Group commercializes vaccines with significant revenue and growth potential. YS Group takes pride in its marketed vaccine product, YSJA™ rabies vaccine, which was the first aluminum-free lyophilized rabies vaccine launched in China. YSJA™ rabies vaccine significantly improves the suitability of human rabies vaccine to rabies in China and causes less pain, injection site discomfort and fever to patients compared with certain other rabies vaccines in China. In addition, YSJA™ rabies vaccine is suitable for mass production and commercialization with long shelf life and low risk to contamination. As of the date of this prospectus, approximately 102.0 million doses of YSJA™ rabies vaccine have been administered for post-exposure protection against rabies. With YS Group's track record of commercialization, YSJA™ rabies vaccine has achieved high production scalability and wide market recognition. Since YS Group commenced the sales of YSJA™ rabies vaccine in October 2020 and as of September 30, 2023, YS Group had sold more than 23.5 million doses of YSJA™ rabies vaccines to 1,718 county-level CDCs in China, covering 59.6% of all county-level CDCs in China.

In addition to the commercialized YSJA™ rabies vaccine, YS Group also has a pipeline of vaccine candidates powered by YS Group's proprietary PIKA immunomodulating technology platform. YS Group's proprietary PIKA immunomodulating technology platform is core to the discovery and development of innovative biologics and will continue to be instrumental to YS Group's success. As of the date of this prospectus, YS Group has a robust portfolio of eight innovative product candidates: (1) four product candidates under various clinical development stages, including PIKA rabies vaccine, PIKA recombinant COVID-19 vaccine, PIKA YS-ON-001 and PIKA YS-HBV-001, and (2) four preclinical stage product candidates, targeting HBV, rabies, influenza and cancer with enormous medical demand. In addition, YS Group is working on a series of therapeutic targets and products at the discovery stage. YS Group has about 70 patents across more than 30 countries and regions relating to its PIKA immunomodulating technology and prophylactic and therapeutic product innovations. YS Group believes that its PIKA immunomodulating technology platform has the potential to nurture a wide variety of innovative vaccines and therapeutic biologics.

YS Group's next-generation product candidate, PIKA rabies vaccine is a new generation rabies vaccine candidate that features accelerated seven-day regimen, fast seroconversion and broad protection against multiple virus strains. YS Group has completed Phase I and Phase II clinical trial of PIKA rabies vaccine in Singapore, and completed Phase I study of PIKA rabies vaccine in China. The Phase I and II clinical studies to date have shown that PIKA rabies vaccine can be used under an accelerated regimen, which achieves a protective level of neutralizing antibodies as early as seven days post the first shot of vaccination and elicit more robust immunogenic response compared to that of the control arm vaccine, which is a widely used and commercially available vaccine. YS Group believes that PIKA rabies vaccine has the potential to elevate the standard of care in post-exposure protection against rabies.

YS Group completed the Phase II and III trials of PIKA recombinant COVID-19 vaccine in the Philippines and UAE. PIKA recombinant COVID-19 vaccine is composed of a PIKA adjuvant and trimeric recombinant full-length, wild-type SARS-CoV-2 spike glycoprotein optimized in the established CHO expression system. YS Group completed Phase I trial of PIKA recombinant COVID-19 vaccine in the UAE in the first half of 2022, and the preliminary results showed that as basic immunization and sequential booster immunization, PIKA recombinant COVID-19 vaccines can induce the production of high-level neutralizing antibodies, which are effective for a variety of mutant strains, including Delta, Omicron sublineages BA.1, BA.2, BA.3, BA.4/5 and BA.2.12.1. In November 2022, YS Group obtained the clearance of Investigational New Drug Application ("IND") for PIKA recombinant COVID-19 vaccine from FDA in the United States. YS Group is currently evaluating the involvement of COVID-19 pandemic, monitoring global health trends, and evaluating market dynamics in order to make appropriate decisions in regard to the optimal commercialization strategies for PIKA recombinant COVID-19 vaccine.

YS Group has been manufacturing YSJA™ rabies vaccine and clinical trial samples of clinical candidates in its current GMP-compliant facilities. YS Group has also obtained patents in relation to its manufacturing techniques and devices. YS Group's current manufacturing facilities have an annual production capacity of approximately 15 million doses of YSJA™ rabies vaccine. YS Group has a comprehensive and highly effective commercialization infrastructure, underpinned by its experienced in-house commercialization team and professional service providers. As of September 30, 2023, YS Group's in-house commercialization team managed its sales and marketing activities

across approximately 329 cities in China. YS Group believes that its product candidates, if approved and launched, will benefit from the operating leverage enabled by YS Group's accumulated commercialization experience and scalable commercialization infrastructure to achieve market success, upon completion of Phase III trials in the relevant countries.

Competitive Strengths

YS Group believes the following competitive strengths contribute to its success and distinguish YS Group from its competitors.

Marketed YSJA™ rabies vaccine with track record of commercialization and significant revenue potential

YS Group is a biopharmaceutical company with innovative technology and a revenue-generating marketed product with growth potential. YSJA™ rabies vaccine is the first aluminum-free lyophilized rabies vaccine launched in China, according to the F&S report, and approximately 102 million doses have been administered to patients for post-exposure protection against rabies. According to the F&S report, the market production value of China's human rabies vaccine market was approximately RMB9.4 billion in 2021. According to the same source, human rabies vaccine is ranked as one of the top five vaccine categories in China in 2020 in terms of market production value. With YS Group's track record of commercialization, YSJA™ rabies vaccine has achieved high production scalability and wide market recognition. In the three fiscal years ended March 31, 2023 and the six months ended September 30, 2023, YS Group had sold more than 23.5 million doses to approximately 1,718 county-level CDCs in China.

YSJA™ rabies vaccine has demonstrated critical advantages in product characteristics and manufacturing, which makes it attractive for commercialization. YSJA™ rabies vaccine significantly improved the suitability of human rabies vaccine to rabies in China by adopting fixed CTN-1 strain to produce vaccine in Vero cells. The homology between CTN-1 strain and most wild Chinese rabies isolates is between 81.5% to 93.4%, much higher than PM1 strain used in other licensed vaccines, according to sequence analysis. YSJA™ rabies vaccine is administered in half of the injection volume of some other rabies vaccines, which causes less pain, injection site discomfort and fever to patients compared with such other rabies vaccines. Developed with Vero cell technology, YSJA™ rabies vaccine is ideal for mass production with low risk of exogenous contamination. In addition, it is in freeze-dried form, which makes it easier to store and transport and less susceptible to changes in temperature, thereby providing longer shelf-life and reducing potential product spoilage. In the three fiscal years ended March 31, 2023 and the six months ended September 30, 2023, YS Group had manufactured approximately 34.6 million doses of YSJA™ rabies vaccine.

As an early entrant in the rabies vaccine industry with a marketed product and an established distribution network, YS Group is well-positioned to capture the fast-growing and vast market in China. According to the F&S report, the market production value of human rabies vaccine in China is expected to increase from RMB9.4 billion in 2021 to RMB22.1 billion in 2025, at a CAGR of 23.8%, and further to RMB33.3 billion in 2030, at a CAGR of 8.5% from 2025 to 2030. YS Group also actively explores opportunities for strategic collaboration and product licensing with leading pharmaceutical companies and investment funds to expand its commercial returns and global presence.

Next-generation product candidate, PIKA rabies vaccine, with accelerated regimen and broad protection against multiple virus strains leads to potentially elevated standard of care and favorable and promising market outlook

YS Group is developing its next-generation product candidate, PIKA rabies vaccine, featuring accelerated regimen and broad protection against multiple virus strains. According to a study by the Guangxi Center for Disease Control and Prevention in China, 78.1% of the failure cases of rabies vaccine occurred from day 6 to day 27 post vaccination. Therefore, faster seroconversion is clinically meaningful. In vaccine immunology, seroconversion signifies the development of specific antibodies in the blood serum as a result of immunization, including vaccination. During seroconversion, the antibody is present but not yet detectable. After seroconversion, the antibody is detectable by standard techniques and could remain detectable for certain period. Determining seroconversion can be important for understanding the immune response, infection rates, and identification of potential serum donors. Seroconversion rates are one of the methods used for determining the efficacy of a vaccine. The higher the rate of seroconversion, the more potentially protective the vaccine for a greater proportion of the population although seroconversion does not inherently confer immunity or resistance to infection. In the case of rabies vaccine, seroconversion was assessed by the serum rabies virus neutralizing antibody (RVNA) titer at pre-defined date post vaccination, and RVNA titer can

[Table of Contents](#)

be determined by the fluorescent antibody virus neutralization (FAVN) test. As for the protection of rabies vaccines, a minimum level of 0.5 IU/mL of the serum RVNA titer is used by the WHO as a correlate of protection. Given that most of recipients of rabies vaccine only seek vaccination post the animal attack or under post-exposure scenario, there is potential exposure of virus infection risk when they are seeking or during the course of vaccination. Therefore, the fast seroconversion also means the earlier protective level of rabies virus neutralizing antibody achieved, which is very meaningful in reducing the virus infection risk. The clinical studies to date have shown that PIKA rabies vaccine can be used under an accelerated regimen, which achieves protective level of RVNA against multiple virus strains as early as seven days post vaccination and elicit more robust immunogenic response compared to that of the control arm vaccine, which is a widely used commercially available vaccine. According to the F&S report, PIKA rabies vaccine has reported the highest seroconversion rate on day 7 among all candidates with published clinical data based on non-head-to-head studies in China so far. Although YS Group conducted head-to-head studies in Singapore, such comparison with other candidates in China was not based on head-to-head studies, YS Biopharma cannot guarantee that similar results would be obtained if additional head-to-head studies are conducted in the future. YS Group believes PIKA rabies vaccine has the potential to elevate the standard of care for rabies vaccine in China and other emerging markets, such as certain Southeast Asian and African countries.

With no overt toxicities from animal studies and no vaccine-related serious adverse events in clinical trials to date, YS Group believes that PIKA rabies vaccine has the potential to elevate the standard of care in human rabies prevention and treatment paradigms. PIKA rabies vaccine's accelerated onset of immune responses allows a three-visit one-week regimen, superior to the currently available vaccine with a five-visit one-month or three-visit three-week regimen, and significantly accelerates generation of immunization from 28 days to seven days, which has the potential of becoming the first accelerated one-week regimen upon the completion of the NDA, according to the F&S report. Based on the clinical trials to date, PIKA rabies vaccine also has a distinct role in promoting cellular, humoral and innate immunity in the type of immune response and thus has the dual character of both a prophylactic and a therapeutic vaccine. PIKA rabies vaccine can quickly induce the production of a variety of chemokines and cytokines, improve the proliferation and activation of immune cells which plays a very important early protective role in patients after exposure. As PIKA rabies vaccine used under accelerated regimen could achieve a protective level of neutralizing antibodies as early as seven days post vaccination, it has the potential to minimize the risk for patients who fail to receive rabies immunoglobulin. Given the insufficient supply and usage of rabies immunoglobulin in the less developed countries, PIKA rabies vaccine has the potential to provide a higher protective level than that of the currently commercially available rabies vaccines.

On September 22, 2017, a WHO expert committee designated PIKA rabies vaccine as an innovative rabies vaccine in a background paper publication and highlighted two advantages of PIKA rabies vaccine as compared to other conventional rabies vaccine: (1) dose reduction (lower antigen use) and (2) accelerated vaccination regimen (shorter injection period from four weeks to one week).

In June 2022, YS Group obtained the approval of the Health Sciences Authority of Singapore ("HSA") for the Phase III clinical trials of PIKA Rabies vaccine to be conducted in Singapore. YS Group has started the trial in the second half of 2023. This Phase III study is a multi-center multi-country study to be conducted in Singapore, the Philippines, Pakistan and Vietnam. In China, YS Group has completed Phase I study of PIKA rabies vaccine, and preliminary results confirmed the dose regimen and safety observed from the Singapore trials. YS Group is currently planning to discuss with NMPA and launch more advanced trials in China. YS Group plans to submit the NDA/BLA for PIKA rabies vaccine to the regulatory authorities in China and major Southeast Asian countries, such as Singapore, upon completion of Phase III trials in the relevant countries.

Strong research and development capabilities underpinned by innovative PIKA immunomodulating technology platform

YS Group has built its business upon strong in-house research and development capabilities. YS Group's in-house developed PIKA immunomodulating technology platform has the potential to generate innovative vaccines. YS Group has a strong research and development team with global vision and rich industry experience. YS Group's fully integrated research and development team consists of approximately 180 members in China, the United States and Singapore with deep scientific talent from early discovery, late stage multi-country clinical development, to pilot and GMP mass production expertise of innovative vaccines and therapeutic biologics. YS Group has four research and development sites located in Maryland (the United States), Singapore, Beijing and Shenyang (China). YS Group also collaborates

with research organizations and government agencies to supplement its in-house efforts and advance the development of its product candidates. YS Group is collaborating with Coalition for Epidemic Preparedness Innovations (“CEPI”) for Phase II clinical study of PIKA recombinant COVID-19 vaccine. In the United States, the National Institutes of Health (“NIH”) has recognized the innovation and the potential of PIKA adjuvant in vaccine and other biologics fields and therefore has included PIKA adjuvant technology in the NIH vaccine adjuvant compendium, to promote scientific exchange and research collaboration around PIKA technology worldwide. YS Group also entered into a global health agreement with Adjuvant, a healthcare focused investment firm with joint objective to expand the commercialization of YSJA™ rabies vaccine in certain low income and lower-middle income countries.

YS Group has developed its PIKA immunomodulating technology platform to empower a robust pipeline of vaccines and therapeutic biologics. YS Group’s proprietary PIKA immunomodulating technology stimulates both humoral and cell-mediated immunity by targeting toll-like receptor-3 (TLR3), retinoic acid inducible gene-I (RIG-I), and melanoma differentiation-associated protein 5 (MDA5). YS Group has thus far applied PIKA immunomodulating technology to multiple areas such as rabies vaccine, COVID-19, HBV and immuno-oncology therapeutic biologics, which have demonstrated substantially enhanced immune responses in relevant preclinical or clinical studies. YS Group has obtained patents relating to PIKA adjuvant in more than 30 countries and regions, which has laid a solid foundation for the commercialization of YS Group’s product candidates across different jurisdictions. YS Group expects its PIKA immunomodulating technology platform to generate various innovative vaccines and therapeutic biologics.

YS Group’s research and development capabilities are further strengthened by the expertise in other key aspects of vaccine and biologics development. For instance, YS Group has developed technology to design protein structures that are optimal for use in vaccines, which were adopted in the design of SARS-CoV-2 virus protein antigen for PIKA recombinant COVID-19 vaccine. YS Group also applied recombinant technology, with which YS Group introduce DNA of an antigen to a cellular expression system and purified such antigens for vaccine production. In addition, YS Group established multiple cell culture technology platforms and adopted bioreactors to increase the effectiveness and efficiency of its research and development efforts and optimize related costs. As formulation technology is critical to the safety, efficacy and stability of vaccines, YS Group has also developed related techniques in stabilizing protein or antigen molecules. For recombinant product candidates, YS Group’s culture media formulations are free of animal components, and its product formulations are free of undesired phenol and preservatives, which helps ensure consistent product quality and reduce the risk of side effects.

YS Group’s scientific advisory board, led by four prominent leaders in their respective fields, provides active guidance on biologics development and technology strategies. Dr. Yunde Hou was one of the two laureates for China’s National Preeminent Science and Technology Award in 2017, the highest scientific award in China, and was also named as the Founder of Genetic Engineering and Father of Recombinant Interferon in China. Mr. Yongxin Yu is a renowned pioneer in the field of vaccinology and virology in China, having led the development of the SA14-14-2 strain for the Japanese encephalitis live attenuated vaccine, which was the first live attenuated vaccine against Japanese encephalitis in the world and suppressed the viral spread in China since its mass adoption. Dr. Mann Fung is the chief executive officer of Tavotek Biotherapeutics and former Vice President of the Johnson & Johnson. Dr. Guang Gao, as the senior technical officer at the Shanghai Representative Office of PATH and former biologist reviewer of Center for Biologics Evaluation and Research (CBER) of the FDA, has extensive experience in GMP manufacturing regulation, regulatory inspection, and review and approval of vaccines and biological products. Members of YS Group’s scientific advisory board play an active role in the review of its product development programs and routinely provide advice and insights on YS Group’s research and development strategy and technical matters.

Robust portfolio of innovative vaccines and therapeutic biologics to drive sustainable value creation

YS Group has a robust portfolio of innovative product candidates based on its PIKA immunomodulating technology platform to address the unmet needs in preventing and/or treating infectious diseases and cancer. As of the date of this prospectus, YS Group has (1) four product candidates under various clinical development stages, including PIKA rabies vaccine, PIKA YS-ON-001, PIKA recombinant COVID-19 vaccine and PIKA YS-HBV-001, among which PIKA rabies vaccine and PIKA YS-ON-001 are categorized under Category I drugs by the NMPA, which are drugs that have a new and clearly defined structure, pharmacological property and apparent clinical value and have not been marketed anywhere in the world, and (2) four preclinical stage product candidates targeting HBV, influenza, rabies and cancer with enormous medical demand.

[Table of Contents](#)

The following list sets forth YS Group's key product candidates, in addition to PIKA rabies vaccine, at various stages of development.

- *PIKA recombinant COVID-19.* PIKA recombinant COVID-19 vaccine is an innovative prophylactic and therapeutics vaccine candidate against multiple SARS-CoV-2 variants. PIKA recombinant COVID-19 vaccine is composed of YS Group's proprietary PIKA adjuvant and recombinant trimeric SARS-CoV-2 spike (S) protein subunit antigen (CHO cells). Results from YS Group's preclinical studies have demonstrated that PIKA recombinant COVID-19 vaccine achieved rapid, long-lasting and broad immune response against SARS-CoV-2. Compared with other COVID-19 vaccines with published data, PIKA COVID-19 vaccine can produce high-level antibodies 14 days after the initial immunization, while other vaccines generally need 3-6 weeks after the initial immunization to induce antibody production. By day 596 post prime vaccination, antibodies elicited by PIKA recombinant COVID-19 vaccine continued to effectively neutralize circulating variants SARS-CoV-2, including D614G, B.1.1.7 (Alpha), B.1.351 (Beta), P.1 (Gamma), B.1.617.2 (Delta) and B.1.1.529 (Omicron). YS Group completed Phase I trial of PIKA recombinant COVID-19 vaccine in the UAE in the first half of 2022, and the preliminary results showed that as basic immunization and sequential booster immunization, PIKA recombinant COVID-19 vaccines can induce the production of high-level neutralizing antibodies, which are effective for a variety of mutant strains, including Delta, Omicron sublineages BA.1, BA.2, BA.3, BA.4/5 and BA.2.12.1. In November 2022, YS Group obtained the clearance of IND for PIKA recombinant COVID-19 vaccine from FDA in the United States. YS Group has completed the enrollment of the multi-center multiple country Phase II/III studies in the Philippines and the UAE. The results of such phase III clinical trial are expected to be available in the first half of 2024.
- *PIKA YS-ON-001.* PIKA YS-ON-001 is an immuno-oncology therapeutic with broad indications for solid tumors. PIKA YS-ON-001 provides strong tumor inhibitory effect as a standalone therapy with tumor growth inhibition index of greater than 50% in 12 animal tumor models. PIKA YS-ON-001 has also demonstrated synergistic effect when combined with checkpoint inhibitors, kinase inhibitors and chemotherapies in multiple animal models of advanced solid tumors, including breast cancer, lung cancer, colorectal cancer and prostate cancer. PIKA YS-ON-001 is also mechanically complementary with other treatment modalities, such as chemotherapies, targeted therapies, local ablation, radiation therapy and oncolytic therapy. PIKA YS-ON-001 has the potential to become an integral immunotherapy component with chemotherapies, targeted therapies and checkpoint inhibitors or with other emerging immunotherapies that produce additive or synergistic treatment benefits. YS Group commenced the cancer patient enrollment for the Phase I clinical study in China in December 2021, focusing on the safety study on late-stage breast cancer, lung cancer, liver cancer and melanoma subjects.

Leveraging its PIKA immunomodulating technology platform, YS Group has developed a pipeline of other product candidates, including prophylactic vaccines such as PIKA YS-HBV-001, PIKA influenza vaccine, as well as therapeutic vaccines such as PIKA YS-HBV-002 for chronic HBV and PIKA YS-ON-002 for solid tumors. YS Group believes that its comprehensive, innovative portfolio of product candidates with commercialization potential will allow YS Group to diversify its revenue sources, sustain its growth and strengthen its competitive advantages.

Established clinical development and manufacturing capability to prepare product launch

From development to manufacture and commercialization, YS Group has optimized every key step towards the success of vaccines and therapeutic biologics. YS Group's clinical development team encompasses personnel with diverse development backgrounds of vaccine and drug products. YS Group's clinical development team has clinical trial experience in areas such as rabies, HBV, influenza, anthrax and oncology in several continents and also accumulated regulatory experience with regulatory authorities in the United States and Asia. The development of adjuvanted vaccines is a specialized and sophisticated field in the biotechnology industry, and YS Group's clinical team has built up first-hand experience in adjuvant selection, dose optimization, study design and pharmaco-vigilance, all of which are crucial to the successful development and application of adjuvants.

The manufacture of vaccines is a complex and lengthy process which directly determines the quality and safety and thus the commercial success of vaccine products. The capability to manufacture vaccines on a commercial scale requires in-depth expertise and process know-how, presenting a significant entry barrier against potential competition.

[Table of Contents](#)

YS Group manufactures YSJA™ rabies vaccine and clinical trial materials in its current GMP-compliant facilities with highly efficient and automated process to ensure high product quality and production efficiency. YS Group's manufacturing center in Shenyang (China) occupies over 12,000 sq.m. with facilities designed and maintained in compliance with GMP standards to yield a current annual production capacity of 15 million doses. YS Group has achieved operational excellence at its manufacturing facilities by adopting production technologies that support large-scale manufacturing, including advanced automation system, high density suspension culture technology and high-throughput chromatography purification technology. YS Group also implements rigorous manufacturing standard and advanced manufacturing system to ensure product quality and safety, such as various bioreactor systems for the mass production of proteins and antigens. YS Group has developed and obtained patents for its manufacturing techniques and devices, including removal of residual DNA and protein impurities, sterilization technology in heating, ventilation, and air-conditioning and cooling system during its manufacturing process to ensure product quality and purity for human use. YS Group is also planning to construct manufacturing facilities with the functions of formulation, filling, freeze-drying and packaging in Singapore.

Established commercialization capabilities and established expansive sales network

With YS Group's track record in commercializing YSJA™ rabies vaccine, YS Group has demonstrated its commercialization capabilities and established its expansive sales network. As of September 30, 2023, YS Group had built its experienced in-house commercialization team with approximately 50 team members and collaborated with about 136 external service providers to achieve expansive coverage across the country. As of September 30, 2023, YS Group had obtained qualifications from 30 province-level CDCs. In the three fiscal years ended March 31, 2023 and the six months ended September 30, 2023, YS Group had sold more than 23.5 million doses of YSJA™ rabies vaccine to approximately 1,718 county-level CDCs in China, representing 59.6% of all the county-level CDCs in China.

YS Group has established a well-designed and highly effective commercialization infrastructure to execute its sales and marketing plans. YS Group's in-house commercialization team diligently manages its sales and marketing activities across approximately 329 cities in China as of September 30, 2023, with an average industry experience of over 12 years such as the sales and marketing of biologics at multinational corporations. With rich industry knowledge and resources, YS Group's in-house commercialization team monitors its sales performance and seeks growth opportunities by ensuring its sales relationships with CDCs in their covered regions. They oversee and coordinate the activities of its external service providers, conduct market research and analysis, and monitor information about its product. YS Group believes that its in-house commercialization team is highly effective to allow YS Group to achieve greater economies of scale, maintain price stability, monitor its customer base, and foster customer loyalty. Through YS Group's in-house commercialization team, YS Group has engaged external service providers to support its sales and marketing efforts among practitioners and execute its sales plan. The extensive network of service providers assists in collecting and providing clinical information of products, including the product quality, safety and adverse event data from the clinical sites, monitoring the shipment and inventory at customer warehouse, managing account payable and payment collection, conducting product training and education programs for practitioner, which greatly strengthens YS Group's product presence and loyalty in the marketplace. Moreover, under the supervision of YS Group's in-house commercialization team, the service providers execute its sales plans effectively with their own sales forces and network resources. YS Group believes that its product candidates will benefit from the operating leverage enabled by YS Group's established and highly scalable commercialization infrastructure, expertise and strategy to rapidly achieve market success.

Seasoned management team with local expertise and global vision and backed by blue-chip investors.

YS Group has a management team with leadership combination of rich local expertise in China and global vision from multinational corporations in the vaccine and pharmaceutical industry, strategizing YS Group's research and development, operations and commercial success. YS Group's management team has comprehensive and complementary capabilities in the vaccine industry, spanning from early research and development, manufacture to commercialization.

[Table of Contents](#)

Mr. Yi Zhang, YS Group's founder and chairman, has over 35 years of experience in China's biopharmaceutical industry and has led various successful national research projects, such as National 863 Scientific Project "SARS Immunoglobulin" and YS Group's National Key New Medical Innovation projects on PIKA rabies vaccine. Mr. Zhang had the first-hand experience in epidemiology, infectious disease control and vaccination campaigns in local CDC offices in China. Mr. Zhang is the lead author of multiple research publications and co-inventor of multiple patents and technologies.

Dr. Hui Shao, YS Group's president and chief executive officer, has over 25 years of distinguished scientific and industrial background in biotechnology and pharmaceutical fields, ranging from drug discovery, business strategy and product commercialization to private and public capital market in the United States, Europe and Asia. Dr. Shao has proven track record of leadership such as in drug innovation at Roche, biotech investment in the United States and strategic alliance transactions in several jurisdictions.

Dr. Zenaida Reynoso Mojares, YS Group's chief medical officer of the Group has over 17 years of experience in the medical and clinical field. Dr. Mojares is a highly accomplished medical professional with diverse experience in medical, clinical research, pharmacovigilance and public health in both private and national government sectors. Prior to joining YS Group, Dr. Mojares had served as the chief medical officer and the head of Clinical Development & Regulatory department respectively at International Vaccine Institute in Seoul, South Korea.

In addition, YS Group's scientific advisory board, established in 2011, plays an active role in the review of YS Group's biologics development programs. YS Group's scientific advisory board currently consists of four reputable leaders in their respective fields of expertise. YS Group believes that the collective knowledge and well-rounded expertise of YS Group's senior management, together with YS Group's scientific advisory board, synergize with each other and provide YS Group with vital guidance and insights in the fast-growing and competitive biopharmaceutical industry.

YS Group's shareholders consist of reputable healthcare investors, endowing YS Group with industry expertise and crucial connections to the pharmaceutical industry in China and worldwide.

Growth Strategies

YS Group's vision is to become a global leader in transformative vaccines and therapeutic biologics. To achieve this goal, YS Group intends to pursue the following strategies.

Maximize and expand commercial potential for YSJATM rabies vaccine in existing markets and other countries untapped

YS Group intends to drive the full-scale commercialization of YSJATM rabies vaccine to capture the robust demand for rabies vaccine existing and prospective markets. The market size of rabies vaccines in China, in terms of market production value, is expected to increase from RMB9.4 billion in 2021 to RMB22.1 billion in 2025, at a CAGR of 23.8%, and further to RMB33.3 billion in 2030, at a CAGR of 8.5% from 2025 to 2030, according to the F&S report. To capture the medical needs in these markets, YS Group expects to expand its manufacturing facilities and bolster its sales efforts. In addition to YS Group's existing manufacturing facilities in Shenyang, China, which have an annual production capacity of approximately 15 million doses of YSJATM rabies vaccines, YS Group plans to build an integrated manufacturing center in Singapore with the functions of formulation, filling, freeze-drying and packaging to boost its overall vaccine and therapeutic biologics production capacities for supply to multiple markets.

YS Group plans to step up the commercialization of YSJATM rabies vaccine in China by both increasing YS Group's market share in those regions where YS Group has established its presence and entering into greenfield markets. By the end of 2022, YS Group plans to leverage its in-house commercialization team and external service providers in China to reach a coverage of approximately 1,900 county-level CDC accounts in China. YS Group also intends to boost the recognition and demand of YSJATM rabies vaccine by pursuing academic communications with CDCs, KOLs and other healthcare professionals specialized in vaccines and disease prevention.

YS Group also plans to unleash the commercial potential of YSJATM rabies vaccine in the underserved markets in Southeast Asian countries, leveraging the significant competitive advantages over the currently available products in those markets. YS Group expects to apply for license in certain Southeast Asian countries and assemble a local sales

[Table of Contents](#)

force with abundant local resources and know-hows. YS Group expects its local sales force to cover major clinical centers and hospitals where the administration of immunological biologics tends to be concentrated, which will allow YS Group to tap into the local markets directly and efficiently. YS Group will also continue to collaborate with the WHO, global institutions and KOLs to promote its marketed products worldwide.

Accelerate the development and commercialization of core product candidates

YS Group has developed PIKA rabies vaccine as next-generation product candidate of rabies vaccine with accelerated regimen and superior profile to capture the demand from China, Southeast Asia and other emerging markets. In June 2022, YS Group obtained the approval of HSA for the Phase III clinical trials of PIKA Rabies vaccine to be conducted in Singapore. YS Group started the trial in 2023. This Phase III study is a multi-center multi-country study to be conducted in Singapore, Philippines and Vietnam. In China, YS Group has completed Phase I study of PIKA rabies vaccine, and preliminary results confirms the dose, regimen and safety observed from the Singapore trials. YS Group is currently planning to discuss with NMPA and launch more advanced trials in China. YS Group plans to submit the NDA/BLA for PIKA rabies vaccine to the regulatory authorities in China and major Southeast Asian countries, such as Singapore, upon completion of Phase III trials in the relevant countries. YS Group believes that its accumulated experience and resources in vaccine sales, manufacture and commercialization will be a strong driving force for the market launch of PIKA rabies vaccine and lay a solid foundation for its future expansion. YS Group plans to expand its manufacturing facilities in Shenyang (China) and establish its manufacturing facilities in Singapore to prepare for the launch of PIKA rabies vaccine and other product candidates.

YS Group also plans to strategically accelerate the development and commercialization of its existing pipeline candidates based on its PIKA immunomodulating technology to realize its full potential in other important prophylactic and therapeutic areas. To address the urgent and strong demand for COVID-19 vaccines with sustainable and broad protections against emerging virus mutants, YS Group submitted the IND application for the prophylactic and therapeutic PIKA recombinant COVID-19 vaccine to regulatory authorities of multiple jurisdictions in 2021. YS Group completed Phase I trial of PIKA recombinant COVID-19 vaccine in the UAE in the first half of 2022 with preliminary results. In November 2022, YS Group obtained the clearance of IND for PIKA recombinant COVID-19 vaccine from FDA in the United States. YS Group has completed the enrollment of the Phase II/III multi-center multi-country clinical studies in the Philippines and UAE. YS Group is currently enrolling cancer patients for the Phase I clinical study of PIKA YS-ON-001 in China. YS Group completed the Phase I clinical trial of PIKA YS-HBV-001 in Singapore in 2017. YS Group expects to enter into Phase II trials in Singapore in 2023. In addition, YS Group expects its immuno-oncology therapeutic candidates to become an integral immunotherapy component in oncology treatment paradigm. To that end, YS Group is pursuing an accelerated development strategy under selected oncology indications in China, the United States and Southeast Asia. In the meantime, YS Group will expedite preclinical development of other pipeline candidates targeting influenza, HPV and multiple oncology indications.

Advance PIKA immunomodulating technology platform and broaden its commercialization potential

YS Group believes that its proprietary PIKA immunomodulating technology platform is core to the discovery and development of innovative biologics and will continue to be instrumental to YS Group's success. YS Group's in-depth understanding in human immunology and the integration of the immunology discovery into product development are pivotal to the accomplishments of its PIKA immunomodulating technology platform. YS Group will continue to invest in its PIKA immunomodulating technology to further enhance its immunological efficacy. In addition, YS Group will continue to boost the intellectual property protection of its PIKA immunomodulating technology and related products.

YS Group plans to continue to leverage its PIKA immunomodulating technology to broaden its commercialization potential by focusing on therapeutic and prophylactic opportunities in immune-related diseases, and develop new product candidates based on its potential benefits such as those in immune modulating pathways and efficacy. YS Group has commenced a series of development programs of immunological biologics in treating and preventing cancer. YS Group will also expedite the preclinical development of other pipeline candidates targeting influenza, HPV and multiple oncology indications. In addition, YS Group plans to collaborate or partner with internationally recognized organizations to advance new immunological biologics product candidates and to enter under-penetrated market territories.

Enhance YS Group's research and development to strengthen competitive advantages in product and technology innovation

YS Group strives to achieve product and technology innovation in immunology and have demonstrated achievements at several stages of research and development. YS Group believes that its research and development capabilities that continuously support its innovation are fundamental to its success. YS Group plans to continue to invest in its research and development initiatives to further its competitive advantages in product and technology innovation. For instance, YS Group plans to build its new research and development center in Singapore to leverage on its deep talent pool and favorable research and development environment as well as access to the Southeast Asian markets. YS Group's Singapore research and development center will encompass a wide spectrum of innovative projects at the clinical stage, ranging from immunology technology and product development, and from vaccines to therapeutic biologics categories.

YS Group also plans to continue to attract, retain and train highly qualified talents to maintain its competitive advantages and support the commercialization of its product candidates. YS Group expects to continue the expansion of its research and development team, especially in China, Southeast Asia and the United States, by recruiting professionals specialized in technology and product candidates relating to vaccines and immunoncology biologics. As it continues to increase the scale and scope of its product portfolio, YS Group expects to strengthen the protection of its intellectual property rights and pipeline assets by recruiting intellectual property specialists and engaging external experts. In addition, YS Group plans to continue the expansion of its regulatory affairs team as YS Group seeks to embark on product development and commercialization in multiple jurisdictions.

Pursue integrated global growth strategy through international collaborations and partnerships

YS Group believes that its marketed product and product candidates with desirable attributes have the potential to benefit patients and gain market acceptance worldwide, especially the emerging markets. YS Group has strategically allocated its research and development, manufacture and commercialization efforts in China, Singapore and the United States to benefit from the clinical, commercial and regulatory advantages across different geographical markets. To transform into a global biopharmaceutical company, YS Group is actively expanding its new drug development, product registration and manufacturing functions, such as its ongoing active talent recruitments in Singapore, as YS Group is positioning its Singapore site as a center of excellence as part of its globalization strategy. In the United States and Europe, YS Group is also expanding its global reach by collaborating with world renowned partners.

YS Group plans to accelerate its business growth by obtaining additional valuable resources through strategic global collaborations and acquisitions. YS Group intends to expand its pipeline through selective collaborations with reputable organizations or institutions, in particular pursuing synergistic co-development opportunities. Furthermore, YS Group intends to seek potential partnership and licensing with leading pharmaceutical companies to commercialize YSJA™ rabies vaccine in Europe, Africa and South America and enhance the commercial returns and presence of its products in multiple jurisdictions. YS Group believes that such effort serves as part of its integrated strategy to drive its sustained growth.



YS Group's Marketed Product and Product Candidates

YS Group adopted a self-developed approach with respect to its PIKA-adjuvanted product pipeline. YS Group's PIKA adjuvant is based on a novel mechanism of action for adjuvants supported by its PIKA immunomodulating technology platform, through which YS Group is developing prophylactic and therapeutic biologics. YS Group has made significant in-house advancement of PIKA immunomodulating technology, such as in researching its mechanism of action, developing multiple clinical applications, establishing PIKA-related manufacturing capabilities and enhancing its IP protection. YS Group further combined PIKA adjuvant with well-established vaccine mechanism of action, such as those for rabies and HBV, to develop a pipeline of innovative vaccines targeting specific viral infections. In addition to leveraging its PIKA immunomodulating technology platform, YS Group's marketed product, YSJA™ rabies vaccine, is a validated, conventional rabies vaccine product based on a well-established mechanism of action of rabies vaccine which provides important market presence and cash flow to support YS Group's ongoing business expansion.

Overview

YS Group’s portfolio consists of nine biologics, including one marketed product, four clinical-stage candidates and four preclinical candidates. In addition, YS Group is working on a series of therapeutic targets and products at the discovery stage. The following table summarizes the development status of its portfolio of marketed product and product candidates.

Conventional Vaccine	Programs	Classification/ Regulatory Designation**	Preclinical	IND	Phase 1	Phase 2	Phase 3	NDA/BLA	Marketed
	YSJA™ (Conventional rabies vaccine)		China						
	PIKA Rabies Vaccine	<i>Category I New Drug (China)</i> <i>PIKA Rabies Vaccine Orphan Drug Designation (rabies vaccine)</i> <i>(U.S. FDA) National Key Medical Innovation Project (China)</i>	Singapore						
Philippines									
Pakistan									
China									
	PIKA Recombinant COVID-19 Vaccine		The UAE						
Philippines									
The U.S.									
	PIKA YS-ON-001 (Cancer)	<i>Category I New Drug (China)</i> <i>Orphan Drug Designation (U.S. FDA for pancreatic cancer and hepatocellular cancer)</i>	Singapore						
China									
	PIKA YS-HBV-001 (HBV vaccine)		Singapore						
	PIKA YS-HBV-002 (Chronic HBV therapy)								
	PIKA YS-ON-002 (Cancer)								
	PIKA Influenza Vaccine								
	PIKA Rabies Vaccine (Human diploid cell)								

 Preclinical stage
  Clinical stage
  Marketed

YS Group’s candidates are subject to approval by the relevant authorities, such as the NMPA of China, the HSA of Singapore and/or other equivalent authorities before commercialization in such jurisdictions.

Vaccine mechanism of action

Vaccine is a biological product to safely induce an immune response that confers protection against infection and/or disease on subsequent exposure to a pathogen. To achieve such goal, vaccines are mostly designed to address natural defense mechanisms and activate the immune system in a manner similar to natural infections. The human immune system comprises two major components: the innate and the adaptive immune system. Innate and adaptive immunity

[Table of Contents](#)

work sequentially to identify invading pathogens and initiate the most effective defense response. The interaction of innate and adaptive immunity is crucial to generate and maintain a protective immune response. Specialized antigen-presenting cells (APCs) are especially important to bridge the two components of the immune system.

The innate immune system represents the first line of host defense against pathogens which includes the body's physical barriers (e.g., skin, mucosal membranes, and enzymes), molecules (e.g., complement) and cells (e.g., macrophages, dendritic cells, neutrophils, monocytes, and natural killer cells). The innate immune system senses the invasion of pathogen via pattern recognition receptors (PRRs) expressed on innate immune cells. Toll-like receptors (TLRs), a class of PRRs, recognize pathogen-associated molecular patterns (PAMPs) that are shared by several pathogens.

For instance, TLR3 recognizes viral double-stranded RNA. The binding of TLRs triggers secretion of chemical messengers, such as cytokines and chemokines, from infected cells and/or innate immune cells to attract other resident and circulating innate cells to the site of infection, and leads to the development of adaptive immune responses.

The adaptive immune system is the second line of immunological defense. Unlike the innate immune defense, which is fast reacting but lacks specificity, adaptive immune responses are antigen specific. Moreover, memory cells are generated in the course of adaptive immune response, which will provide a faster and stronger immune response when the body encounters the same pathogen in the future. The adaptive immune responses are mediated by APCs that capture and digest the antigen that are complexed with major histocompatibility complexes (MHCs) and presented to lymphocytes. There are two subsets of lymphocytes, namely B cells and T cells. Activated B cells can produce and secrete antigen specific antibodies that can facilitate phagocytosis or complement-mediated killing of pathogens or neutralize toxins by binding to their appropriate antigens. There are two major subsets of T cells, CD4+ T cells with regulatory functions and CD8+ T cells with effector functions. In most cases CD4+ cells will help other immune cells perform their task and are referred to as helper T cells (Th). T helper 2 (Th2) cells secrete mainly interferon-gamma (IFN γ), a cytokine known to limit pathogen survival and promote the differentiation of CD8+ cells. Th2 cells produce various cytokines (e.g., interleukins (IL) including IL-4, IL-5 and IL-13) that preferentially activate innate immune cells (e.g., eosinophils and mast cells) and facilitate especially the immune response to extracellular pathogens. Another subset, termed follicular T helper cell (T_{fh}) is characterized by the secretion of IL-21, a cytokine thought to favor the secretion of antibodies by antigen-specific B cells. Finally, regulatory CD4+ T cells (Treg cells) inhibit immune or inflammatory responses by blocking the activity of effector T cells, helper T cells, and APCs.

CD8+ T cells can destroy cells infected by intracellular pathogens such as viruses by secretion of cytotoxic factors. In addition, CD8+ T cells can inhibit viral replication without destroying the infected cells by producing cytokines (interferon) to interfere with pathogen replication. CD8+ cytotoxic cells also can eliminate cells exhibiting abnormal host peptides, such as those presented by tumor cells, and therefore play an important role in the immune control of aberrant cell growth.

YSJA™ Rabies Vaccine — YS Group's marketed product

YSJA™ rabies vaccine is an aluminum-free, inactivated Vero cell based vaccine, which is the first aluminum-free lyophilized rabies vaccine developed in China. Since its launch in 2003, approximately 98 million doses have been administered to patients for post-exposure protection against rabies. YSJA™ rabies vaccine improves the suitability of human rabies vaccine to rabies in China and causes less pain, injection site discomfort and fever to patients compared with certain rabies vaccines in China. YS Group's current manufacturing facilities in Shenyang, China received the GMP certificate in July 2019, pursuant to which YS Group started the production of YSJA™ rabies vaccine in February 2020 and its sales in October 2020. Since October 2020 and up to September 30, 2023, YS Group sold more than 23.5 million doses of YSJA™ rabies vaccines to 1,718 county-level CDCs in China.

Mechanism of action

Rabies neutralizing antibodies are widely accepted to correlate with the protection against rabies. A minimum level of 0.5 IU/mL is used by the WHO as a correlate of protection. This level of rabies virus neutralizing antibodies should be achieved by day 14 of post-exposure immunization.

Market opportunity and competition

Human rabies is a viral disease that causes acute encephalitis with almost 100% mortality rate if postexposure prophylaxis (PEP) is not administered timely prior to the onset of symptoms. In most developing countries, immediate PEP is adopted to control the incidences and deaths from rabies.

[Table of Contents](#)

Human rabies occurs in more than 150 countries and territories worldwide and is a significant public health concern in developing countries, especially in many Asian and African countries, with approximately 35,000 rabies-caused deaths occurring each year in Asia, according to the WHO. According to the F&S report, approximately 49 million of people were bitten by dogs and other rabies-carrying animals in China in 2021, and this number is expected to increase to 52 million in 2025 and further to 55 million in 2030. The penetration rate of rabies vaccine was 40.6% in 2021, and is expected to increase to 65.7% in 2025 and further to 75.5% in 2030. Thanks to human rabies vaccine, the number of new incidences of rabies infection in China decreased from 801 in 2015 to 290 in 2019, out of which the number of deaths was 744 and 276 in 2015 and 2019, respectively, and human rabies vaccine is expected to continue to play a critical role in suppressing rabies in China in the future.

Due to various factors such as the change in the number of market players, adjustment in production volume and the impact of a scandal involving the then second largest rabies vaccine manufacturer in July 2018, the market value of China's rabies vaccine fluctuated during 2015 and 2019, with an overall decline at a negative CAGR of 4.7%. China's human rabies vaccine market production value is expected to increase from RMB9.4 billion in 2021 to RMB22.1 billion in 2025 at a CAGR of 23.8%, and is expected to reach RMB33.3 billion in 2030 at a CAGR of 8.5% from 2025 to 2030.

Advantages

YSJA™ rabies vaccine uses fixed CTN-1 strain to produce vaccine in Vero cells, which demonstrates advantages such as:

- *Improved suitability for rabies in China.* The sequence analysis has shown that the homology between CTN-1 strain and most wild Chinese rabies isolates was between 81.5% to 93.4%, higher than PM-1 strain used in other licensed vaccines, which has made CTN-1 strain more suitable for rabies in China. Approximately 98 million doses of YSJA™ rabies vaccine have been administered in China.
- *Higher immunogenicity.* A head-to-head study conducted by an independent clinical research group in 2007 demonstrated that CTN-1 strain-derived rabies vaccine produced higher immunogenicity than rabies vaccine using other virus strains.
- *Better safety profile.* According to a head-to-head study, the administration of YSJA™ rabies vaccine causes less pain and injection site discomfort to patients. YSJA™ rabies vaccine is also associated with a lower rate of fever compared with certain other rabies vaccines in China.

Four head-to-head clinical studies were conducted by certain CDC centers in China to evaluate the safety and adverse reactions between the YSJA rabies vaccine and other rabies vaccines marketed by other producers. Such trials included both children under 10 years old and adult patients. The head-to-head study among adult patients also evaluated the immune responses of various human use rabies vaccines marketed in China.

The material details of such four head-to-head clinical studies are set out below:

- (1) A head-to-head clinical study conducted by Guangxi CDC center in China to evaluate adverse reactions of YSJA rabies vaccine and another leading product in China among children under 10 years old.

The trial enrolled 1025 children under 10 years old including 477 subjects and 548 subjects receiving YSJA rabies vaccine and the comparison vaccine, respectively. The results showed that the rate of fever among patients receiving the comparison vaccine was 48.4% (265/548), higher than the rate of fever to patients of YSJA rabies vaccine 18.4% (88/477) ($P < 0.05$). In the comparison group, fever was most common in children under 3 years old. The older the age, the lower the probability of fever. The study recommended to use YSJA rabies vaccine for children under 10 years old, especially under 3 years old to reduce the incidents of adverse reactions.

- (2) A head-to-head clinical study conducted by Guizhou CDC center in China to evaluate adverse reactions and immune response of YSJA rabies vaccine and another leading product among adult patients.

The 100 subjects enrolled in the study were randomized into two groups (50 in study group receiving YSJA rabies vaccine and 50 in control group receiving the other leading products). The result showed there were three cases of adverse reactions reported in the YSJA rabies vaccine group, lower than the total number

of adverse reactions in the control group of 10 cases (20%). Comparing the antibody seroconversion rate between two groups, the total number of seroconversion cases in the study group was 49 (98%), and the total number of seroconversion cases in the control group was 40 (80%) ($P < 0.05$). The study concluded that the adverse reaction rate of YSJA rabies vaccine was lower and the seroconversion rate was higher comparing to those of the other leading product.

- (3) A head-to-head study conducted by Qiannan CDC center in Guizhou, China to evaluate adverse reactions of YSJA rabies vaccine and another leading product in China.

The trial enrolled 206 post-exposure patients including 102 subjects and 104 subjects receiving YSJA rabies vaccine and the comparison vaccine, respectively to observe the incidence of adverse reaction after 72 hours of the injection. The results showed that the adverse reactions rate receiving the comparison vaccine was 24.03%, higher than the adverse reactions rate receiving YSJA rabies vaccine 8.82%. The difference was statistically significant ($P < 0.01$). The study recommends using YSJA rabies vaccine as the first choice due to its lower rate of adverse reactions.

- (4) A head-to-head clinical study conducted by Yiwu CDC center in Zhejiang, China to evaluate adverse reactions of YSJA rabies vaccine with an imported lyophilized rabies vaccine and another domestic liquid rabies vaccine.

The trial enrolled 300 post-exposure patients who were randomized into three groups (100 subjects receiving YSJA rabies vaccine, 100 subjects receiving an imported lyophilized rabies vaccine and 100 subjects receiving a domestic liquid rabies vaccine) to observe the adverse reaction incidences and the immune responses after 14 and 42 days of the first injection, respectively. The results showed that the local adverse reactions rates receiving the YSJA rabies vaccine, imported lyophilized rabies vaccine and domestic liquid rabies vaccine were 3.6%, 3.2% and 28.6% respectively and the systemic adverse reactions rates for the 3 groups were 1.2%, 0.8% and 4.4% respectively. Comparing the seroconversion rate measured by neutralizing antibody titers among 3 groups, the seroconversion rates receiving the YSJA rabies vaccine, imported lyophilized rabies vaccine and domestic liquid rabies vaccine were 96%, 98% and 82% after 14 days of the first injection; 98.98%, 98.99% and 93.68% after 42 days of the first injection. The study concluded that, compared to the liquid rabies vaccine, the lyophilized rabies vaccine showed statistical significance with lower adverse reaction rate, higher seroconversion rate and longer terms of validity. There was no statistical significance between YSJA rabies vaccine and the imported lyophilized rabies vaccine in terms of the adverse reaction rate and seroconversion rate but YSJA rabies vaccine was more affordable with a lower price for most post-exposure patients to meet their needs domestically.

Moreover, the adoption of purified Vero cell technology in YSJA™ rabies vaccine offers several advantages in terms of mass production, such as:

- *High production scalability.* Purified Vero cell technology provides high scalability suitable for mass production, which also achieves high product quality and low risk of exogenous contamination, based on the Technical Guidelines for Human Rabies Prevention and Control (2016) issued by the national CDC in China.
- *Established product profile.* Approximately 97 million doses of YSJA™ rabies vaccine have been administered in China, consistent with less side effects of rabies vaccines under Vero cell technology claimed by Technical Guidelines for Human Rabies Prevention and Control (2016).
- *Enhanced convenience and stability.* YSJA™ rabies vaccine is in freeze-dried (as opposed to a liquid) form, and is easier to store and transport as well as less susceptible to changes in temperature, reducing potential product spoilage.
- *Reliable purity.* YS Group has successfully developed a series of proprietary and patented purification technologies to effectively remove residual DNA and protein impurities during the manufacturing process, which helps ensure the quality and purity of YS Group's vaccine products for human use.

Commercialization and marketing plan

YS Group received the GMP certificate for its manufacturing facilities in Shenyang, China in July 2019, pursuant to which YS Group started the production of YSJA™ rabies vaccine in February 2020 and the sales in October 2020. In the three fiscal years ended March 31, 2023 and the six months ended September 30, 2023, YS Group sold more than 23.5 million doses to 1,718 county-level CDC customers in China. In addition, YS Group developed more advanced bioreactor engineering process to further improve its production throughput, efficiency and quality control. Under its business expansion strategy, YS Group continues to increase the number of its in-house commercialization team and increase the number of external service providers to reach its target coverage of county-level CDC customer accounts of approximately 2,126 in China.

To expand its international market operation, YS Group also seeks potential partnerships and licensing with leading pharmaceutical companies to commercialize YSJA™ rabies vaccine in certain international markets. YS Group intends to expand its commercialization efforts into countries across Asia, the Middle East, Europe, and North, Central and South America.

YS Group's clinical stage product candidates

Leveraging its proprietary PIKA immunomodulating technology platform, YS Group has developed a pipeline of product candidates targeting viral infections and cancer. YS Group's PIKA molecule is a class of double strand RNA (dsRNA) molecules of well-defined, specific ribonucleic acid units and molecular weight distribution synthesized with YS Group's proprietary technology. Endosomal dsRNA can be recognized by TLR3 while cytosolic dsRNA can be sensed by the retinoic acid-inducible gene (RIG) I-like receptor (RLR) family which include RIG-I and melanoma differentiation-associated protein 5 (MDA5). The immuno-potentiating effects of PIKA include: (1) promoting the activation and maturation of dendritic cells, (2) up-regulating the co-stimulatory molecules, such as CD80, CD86 and HLA-DR on dendritic cell, (3) activating and promoting the maturation of dendritic cells, (4) enabling the dendritic cells to act as potent antigen presenting cells for effective activation of naive B and T lymphocytes which in turn lead to a more robust specific immune response, (5) inducing the activation and proliferation of both B cells and NK cells, (6) triggering the TLR3 pathway which induces IL-2 and type I IFNs production, (7) improving MHC category II expression and cross-presentation of antigen, and (8) promoting Th1 (cellular) based immunity through its induction of IL-2 and type I IFNs. For more details, see “— Research and Development — PIKA Immunomodulating Technology Platform.” The following figure sets forth the signaling pathway and function of PIKA.

Figure 1. Signaling Pathway and Function of PIKA

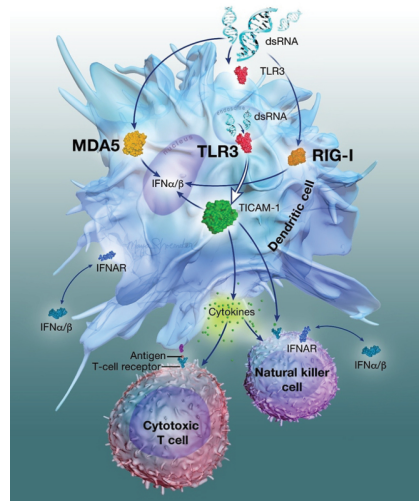

PIKA Rabies Vaccine

PIKA rabies vaccine is a lyophilized human-use rabies vaccine composed of cell culture-derived rabies antigen mixed with PIKA adjuvant which acts as a TLR3 agonist. This vaccine candidate is based upon YS Group's deep foundation in YSJA™ rabies vaccine, coupled with YS Group's proprietary PIKA adjuvant and advanced manufacturing techniques. Leveraging YS Group's proprietary PIKA immunomodulatory technology platform, PIKA rabies vaccine is designed to induce accelerated and strong cellular immunity and stimulate the body to rapidly produce higher humoral immune response. Its accelerated onset of immune response allows a three-visit one-week regimen superior to the currently available vaccine with a five-visit one-month or three-visit three-week regimen, which shortens the treatment period by two to three weeks. It also significantly accelerates generation of immunization from 28 days to seven days, which has the potential of becoming the first accelerated one-week regimen upon the completion of the NDA. This vaccine candidate was designated by a WHO expert committee background paper publication as an innovative rabies vaccine.

YS Group received the approval of the Phase III clinical trials of PIKA Rabies vaccine from the regulatory authorities in the Philippines, Singapore and Pakistan. YS Group intends to start the trial in the 2023. This Phase III study is a multi-center multi-country study to be conducted in Singapore, Philippines and Pakistan. In China, YS Group has completed Phase I study of PIKA rabies vaccine and preliminary results confirm the dose, regimen and safety observed from the Singapore trials. YS Group is currently discussing with NMPA in 2023 and expects to launch more advanced trials in China afterwards. Upon completion of successful Phase III trials in the relevant countries, YS Group plans to submit the NDA/BLA for PIKA rabies vaccine to the regulatory authorities in countries across Asia, Africa, the Middle East, Europe, and North, Central and South America.

Mechanism of action

PIKA rabies vaccine is composed of cell culture-derived rabies antigen mixed with PIKA adjuvant that is acting as a TLR3 agonist. As a result, PIKA rabies vaccine has a distinct role in promoting cellular and humoral immunity and thus has the dual prophylactic and post-exposure therapeutic characteristics. In particular, the high level of innate immune response and balanced Th1/Th2 immune response induced by PIKA rabies vaccine play a crucial role in the protection of rabies virus. PIKA rabies vaccine can quickly induce the production of a variety of chemokines and cytokines, and improve the proliferation and activation of immune cells, which plays a very important early protective role in patients after exposure. For a description of mechanism of action for rabies vaccines, see “— YSJA™ Rabies Vaccine — YS Group's Marketed Product — Mechanism of Action” above.

Market opportunity and competition

According to the CDE and the F&S report, there were 23 human rabies vaccine candidates in China as of December 31, 2021. For the market opportunity for rabies vaccine, including incidence and prevalence of rabies, treatment options and costs, see the section entitled “— YSJA™ Rabies Vaccine — YS Group's marketed product — market opportunity and competition.” The WHO and the national CDC in China recommend PEP in the combination of vaccine and rabies immunoglobulin injections. However, the current supply of human rabies immunoglobulin can only meet the less than 10% of the overall demand, according to the F&S report, and most patients only receive rabies vaccine after the exposure, representing a significant addressable market in patients who fail to or otherwise cannot adopt immunoglobulin.

PIKA rabies vaccine is under clinical trial indicated for both pre- and post-exposure rabies prophylaxis and was designated by a WHO expert committee document as innovative rabies vaccine in 2017. This product candidate was also granted ODD by the U.S. FDA for prevention of rabies infection including post-exposure prophylaxis for against rabies. PIKA rabies vaccine is designed as a premium product that targets the high-end rabies vaccine market and differentiates from existing conventional rabies vaccines. YS Group expects it to become the next generation of rabies vaccine and capture significant opportunity in China and other emerging markets, or even replace conventional rabies vaccines, given its accelerated one-week regimen, and enhanced protection level, especially in light of the insufficient supply and usage of rabies immunoglobulin in less developed countries. As PIKA rabies vaccine is entering Phase III clinical development, YS Group is also exploring potential partnerships to jointly commercialize this promising product in many countries.

Advantages

According to the WHO guidance, the most commonly used biologics to treat rabies are PEP regimen that consists of rabies vaccine with the combination of rabies immunoglobulin. However, they have the following limitations:

- *PEP rabies vaccine regimens.* The two most common PEP rabies vaccination regimens are the Essen (five injections administered on days 0, 3, 7, 14, and 28) and the Zagreb schedule (two injections administered on day 0 and one injection on days 7 and 21). However, the administration of PEP must be as early as possible to give the optimal chance of protection against developing clinical disease. Deviation from the recommended PEP protocol could also result in clinical rabies. In addition, fatalities are common even after the administration of appropriate PEP, particularly when rabies immunoglobulin has not been either administered or appropriately administered. Severe bites to highly innervated areas, such as face, neck or hand, significantly shorten the incubation period, which causes insufficient time for the development of a protective immune response. Suboptimal response of current vaccine has been reported in populations with compromised immunity, such as HIV/AIDS-infected patients, and with immature immunity, such as children. The WHO has recognized the limitations of current rabies PEP practice and is tasked to reduce the duration of course and number of doses administered under the current PEP regimen. Animal challenge experiments have also *indicated* that rabies vaccine alone does not offer guaranteed protection because the injection of the vaccine usually takes 10-12 days to produce sufficient antibodies, which lags behind the time that the virus proliferates and invades the nerve tissue in the local muscle cells.
- *Rabies immunoglobulin.* The treatment currently recommended by the WHO requires the administration of rabies immunoglobulin, which is a type of rabies neutralizing antibodies derived from human blood, together with rabies vaccines. The injected antibodies act to neutralize the rabies virus before the human immune system produces its own antibodies. However, immunoglobulin is often expensive and limited in supply in developing countries. In China, the adoption rate of rabies immunoglobulin is relatively low. According to the Technical Guidelines for Human Rabies Prevention and Control (2016), it is estimated that over 90% of post-exposure patients at clinics in some provinces with higher incidence of rabies in China can be classified as category II and III which require the PEP regimen of rabies vaccine with the combination of rabies immunoglobulin, of which approximately 40% falls under category III, the most severe type in terms of wounds. However, the local injection of rabies immunoglobulin is still a painful and costly procedure, and it is estimated that only 15% of category III patients received rabies immunoglobulin injection, according to the same source.

The excellent immunogenicity and lack of serious adverse events under the accelerated PIKA rabies vaccine program has been recognized by the WHO. The WHO highlighted PIKA rabies vaccine in their 2017 background paper on rabies. A successful PIKA rabies vaccine will further the WHO's agenda to reduce the course of rabies vaccine. PIKA rabies vaccine has the following advantages over the existing rabies vaccine.

- *Dual prophylactic and therapeutic characters.* PIKA rabies vaccine has a distinct role in promoting cellular and humoral immunity in the type of immune response and thus has the dual character of both prophylactic and therapeutic vaccines. In particular, balanced CD4 and CD8 cellular immune responses play a key role in post-exposure immune protection.
- *Earlier and higher neutralizing antibody production.* The improved 2-2-1 immunization regimen provides accelerated and strong specific immune response for early protection and improves the patient compliance of immunization. The clinical studies to date have shown that PIKA rabies vaccine can be used under an accelerated regimen, achieving protective level of neutralizing antibodies as early as seven days post vaccination, eliciting more robust immunogenic response compared to that of the control arm vaccine, which is a widely used commercially available vaccine. PIKA rabies vaccine has also showed good reactogenicity and tolerability, comparable to that of the commercially available vaccine.

[Table of Contents](#)

- *Induction of strong cellular immunity:* PIKA rabies vaccine can activate cellular immunity, including specific and nonspecific cellular immunity. Clinical study has shown that PIKA rabies vaccine is capable of inducing more potent T cell response than currently available rabies vaccines, which is beneficial for protection after exposure.
- *Potential to enhance protection without immunoglobulin.* PIKA rabies vaccine used under accelerated regimen may achieve protective level of neutralizing antibody as early as seven days post vaccination, which minimize the risk for patients who fail to adopt rabies immunoglobulin. Given the insufficient supply and low adoption rate of immunoglobulin in China and other developing countries, PIKA rabies vaccine has the potential to enhance the protection level than that of commercially available rabies vaccine.

Summary of preclinical and clinical studies

To capture the underserved market demand for new generations of rabies vaccines in the emerging markets, YS Group has developed a global clinical development plan comprising, generally in chronological order, the following clinical trials:

- (1) a Phase I trial among 37 healthy volunteer subjects in Singapore, completed in February 2016;
- (2) a Phase II trial among 126 healthy volunteer subjects in Singapore, completed in July 2016;
- (3) a Phase I trial among 96 healthy volunteer subjects in China to confirm the dose regimen and safety observed in Singapore clinical trials, completed in 2021;
- (4) a multi-country, multi-center Phase III registration trial among approximately 4,500 healthy subjects using a post exposure prophylaxis schedule in multiple Southeast Asian countries, expected to be completed by the end of 2024; and
- (5) more advanced trials to be conducted in China upon the consultation and approval by the NMPA in China.

YS Group received the approval of the Phase III clinical trials of PIKA Rabies vaccine from the regulatory authorities in the Philippines, Singapore and Pakistan. YS Group has started the trial in 2023. This Phase III study is a multi-center multi-country study to be conducted in Singapore, Philippines and Pakistan. In China, PIKA rabies vaccine completed Phase I study of PIKA rabies vaccine to confirm the dose, regimen and safety observed from the Singapore trials. YS Group plans to conduct more advanced clinical trials in China upon the consultation and approval by the NMPA in China.

YS Group started the pivotal Phase III clinical trials in Southeast Asia in healthy volunteers without exposure to animal bite, which are approximately 4,500 subjects in total, in the first half of 2023. YS Group is currently discussing with NMPA and expects to launch more advanced trials in China afterward. Upon completion of successful Phase III trials in the relevant countries, YS Group plans to submit the NDA/BLA for PIKA rabies vaccine to the regulatory authorities in countries across Asia, Africa, the Middle East, Europe, and North, Central and South America.

Preclinical Study

PIKA rabies vaccine has been extensively investigated in several animal models for immunogenicity and protective efficacy. In post-exposure efficacy test, groups of hamsters were infected with lethal dose of wild type BD06 strain rabies virus followed by immunization with normal saline, human rabies immunoglobulin (HRIG), vaccine control of standard regimen (days 0, 3, 7, 14 and 28), PIKA rabies vaccine of standard regimen, and PIKA rabies vaccine of accelerated regimen (double dose on days 0, 2 and single dose on day 7) respectively. The results showed PIKA rabies vaccine administered using a standard regimen conferred 66.7% survival rate and 80% with an accelerated regimen,

compared to 20% survival rate provided by standard regimen of commercially available rabies vaccine (Figure 2). Animal studies have shown that administration of PIKA rabies vaccine using accelerated regimen results in improved survival in infected mice and high levels of neutralizing antibody production as early as four days after immunization.

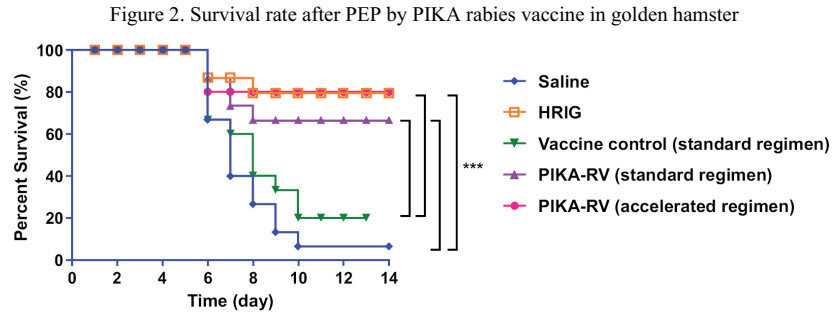

Significant difference between survival curves was determined by the Chi-square test (***) $p < 0.005$. There is no significant difference between the groups not marked.

To further evaluate the efficacy of PIKA rabies vaccine, the representative strains of seven major rabies virus populations in the world were used as challenge viruses to challenge mice. In each challenge study with variants of street rabies virus, groups of mice were challenged with lethal dose of different strain rabies virus followed by immunization with PBS, Commercial Rabies Vaccine of standard regimen (days 0, 3, 7, 14 and 28), and PIKA rabies vaccine of accelerated regimen (double dose on days 0, 2 and single dose on day 7) respectively. The results showed that compared with the commercial rabies vaccine, the PIKA rabies vaccine could provide a more comprehensive protective effect, with a protective effect of more than 80% on all seven viruses (Table 2). In addition, PIKA rabies vaccine demonstrated quick onset of neutralization antibody titers and higher seroconversion rate at day 5 post the first dose injection of vaccines.

Phase I Clinical Trial in Singapore

The Phase I clinical trial of PIKA rabies vaccine was conducted in Singapore. The study was a singlecenter, open label, randomized study in healthy naive adult subjects to determine the safety and immunogenicity of PIKA rabies vaccine. A total of 37 subjects were enrolled and randomly assigned to receive Rabipur, standard PIKA rabies vaccine and accelerated PIKA rabies vaccine. The vaccine dosage of Phase I clinical trial in Singapore was 1.0 mL. Rabipur marketed by Novartis is a commercialized rabies vaccine which was produced using Flury LEP rabies virus strain grown in a culture of primary chick embryo fibroblast cells. The dosing regimen for Rabipur recommended by the United States Centers for Disease Control and Prevention is four doses which are to be administered on days 0, 3, 7 and 14. No deviation from such approved regimen, including accelerated regimen, was allowed in humans with respect to Rabipur.

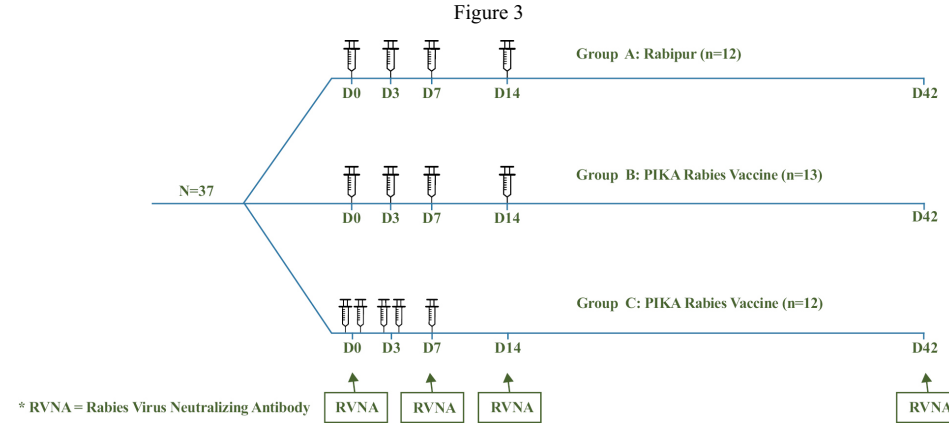

[Table of Contents](#)

The groups of Rabipur and standard PIKA rabies vaccine followed the same vaccine regimen (1-1-1-1), where one injection on days 0, 3, 7 and 14 each was administered. The group of accelerated PIKA rabies vaccine received the accelerated regimen (2-2-1), where two injections on both days 0 and 3 were administered in different arms, and only one injection was administered on day 7. Seroconversion is defined as post-vaccination serum rabies virus neutralizing antibody (RVNA) titer equal to or higher than 0.5 IU/mL, while the RVNA is absent in pre-vaccination serum. Such seroconversion as defined in YS Group's clinical trials is in line with those of other clinical trials for rabies vaccines. The Phase I clinical trial has demonstrated that, on day 7 under same 1-1-1-1 dosing regimen, only 16.7% of subjects receiving Rabipur seroconverted compared to that of 50% of subjects receiving PIKA rabies vaccine. Under the accelerated regimen, the PIKA rabies vaccine had a higher seroconversion rate with 75% by day 7, significantly higher than the control arm vaccine under the classic regimen. In addition to achieving higher immunogenicity, PIKA rabies vaccine elicited CD4 mediated T cell response detectable as early at day 7 which was maintained at day 42. No death or serious adverse events were reported in this trial. All adverse events in both the PIKA vaccine arms and the Rabipur arm are mild in severity. The incidence of adverse events is comparable between the PIKA vaccine arms and the Rabipur arm. The result has showed that PIKA rabies vaccine is safe and well tolerated. The following table sets forth the Phase I clinical results in Singapore concerning adverse events.

System Organ Class (SOC)	Preferred term (PT)	Rabipur	PIKA Rabies	PIKA Rabies
		N=12	Vaccine	vaccine
		(in n (%))	(1-1-1-1) N=13	(2-2-1) N=12
		(in n (%))	(in n (%))	(in n (%))
Gastrointestinal disorders	Diarrhoea	1 (8.33)%	0 (0.00)%	1 (8.33)%
	Nausea	0 (0.00)%	1 (7.69)%	0 (0.00)%
General disorders and administration site conditions	Induration	1 (8.33)%	0 (0.00)%	0 (0.00)%
	Fatigue	1 (8.33)%	0 (0.00)%	0 (0.00)%
	Injection site pain	0 (0.00)%	6 (46.15)%	3 (25.00)%
	Injection sites welling	0 (0.00)%	1 (7.69)%	0 (0.00)%
	Pyrexia	0 (0.00)%	1 (7.69)%	0 (0.00)%
Infections and infestations	Lymph gland infection	1 (8.33)%	0 (0.00)%	0 (0.00)%
	Pyuria	0 (0.00)%	2 (15.38)%	1 (8.33)%
Investigations	Glucose urine present	0 (0.00)%	2 (15.38)%	0 (0.00)%
Musculoskeletal and connective tissue disorders	Myalgia	0 (0.00)%	0 (0.00)%	1 (8.33)%
Nervous system disorders	Dizziness	0 (0.00)%	1 (7.69)%	0 (0.00)%
	Headache	0 (0.00)%	1 (7.69)%	1 (8.33)%
	Lethargy	1 (8.33)%	0 (0.00)%	1 (8.33)%
Renal and urinary disorders	Proteinuria	0 (0.00)%	2 (15.38)%	0 (0.00)%

System Organ Class (SOC)	Preferred term (PT)	Rabipur	PIKA Rabies	PIKA Rabies
		N=12	Vaccine	vaccine
		(in n (%))	(1-1-1-1) N=13	(2-2-1) N=12
		(in n (%))	(in n (%))	(in n (%))
Respiratory, thoracic and mediastinal disorders	Cough	0 (0.00)%	1 (7.69)%	0 (0.00)%
Skin and subcutaneous tissue disorders	Hyperhidrosis	0 (0.00)%	1 (7.69)%	0 (0.00)%
	Pruritus	0 (0.00)%	1 (7.69)%	0 (0.00)%
	Urticaria	0 (0.00)%	0 (0.00)%	1 (8.33)%
Total number of subjects with at least one adverse event		5 (41.67)%	9 (69.23)%	6 (50.00)%

Figure 4. Percentage of subjects with protective serum neutralizing antibodies

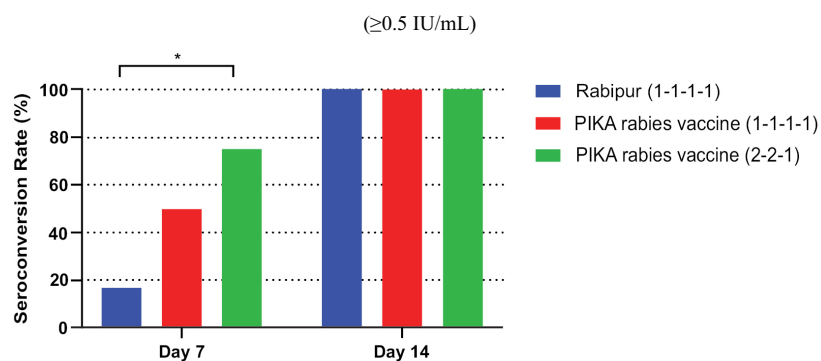

Significant difference between seroconversion rate was determined by Fisher’s exact test ($p < 0.05$). There is no significant difference between the groups not marked.

At the last visit day (day 42), the levels of neutralizing antibody titer in PIKA rabies groups, being administered under either the 1-1-1-1 or the 2-2-1 regimen, were comparable to that of the control group. The follow table sets forth the levels of neutralizing antibody titer on day 42 in Phase I clinical trial in Singapore.

	Rabipur	PIKA Rabies Vaccine (1-1-1-1)	PIKA Rabies Vaccine (2-2-1)
	mean \pm standard deviation 95% confidence interval	mean \pm standard deviation 95% confidence interval	mean \pm standard deviation 95% confidence interval
Neutralizing antibody titer	9.72 \pm 11.66 (-2.67, 22.11)	12.07 \pm 10.07 (-0.31, 24.46)	20.06 \pm 33.12 (8.26, 33.04)

Phase II Clinical Trial in Singapore

Phase II clinical trial was conducted in two hospitals in Singapore. It was a multicenter, open label, randomized, non-inferiority study in healthy naive adult subjects to evaluate the efficacy and safety of the PIKA rabies vaccine under an accelerated regimen. 126 participants were enrolled and randomized into two groups, receiving Rabipur and PIKA rabies vaccine. PIKA rabies vaccine recipient achieved higher seroconversion rate (57.6%) at day 7 as compared to Rabipur (43.8%). All subjects in both PIKA rabies vaccine and Rabipur groups achieved seroconversion. The primary endpoint of non-inferiority was met. Phase II clinical trial further supported the efficacy of the PIKA rabies vaccine under accelerated regimen, with earlier and higher production of neutralizing antibody as early as seven days after vaccination. Consistent with the adverse events findings in Phase I, no death or serious adverse events were reported in this trial. The majority of adverse events in the clinical trials conducted on PIKA rabies vaccine are mild to moderate in severity. The incidence of adverse events is comparable between the PIKA rabies vaccine arm and the Rabipur arm. The safety and tolerability profile of the PIKA rabies vaccine in such large sample size trial was comparable to that of Rabipur.

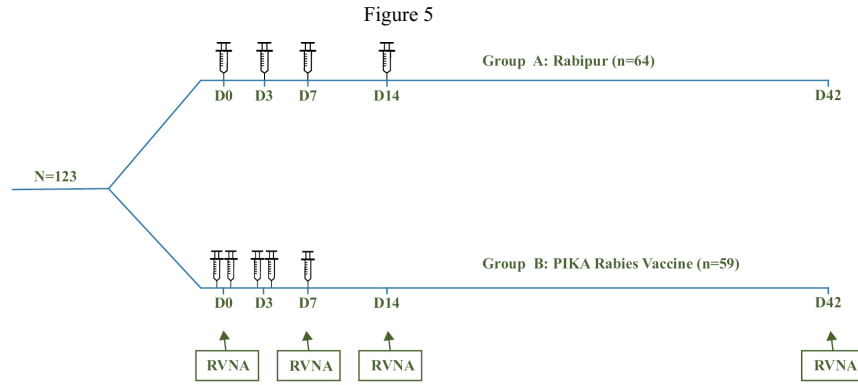

* RVNA = Rabies Virus Neutralizing Antibody

Figure 6. Percentage of subjects with protective serum neutralizing antibodies

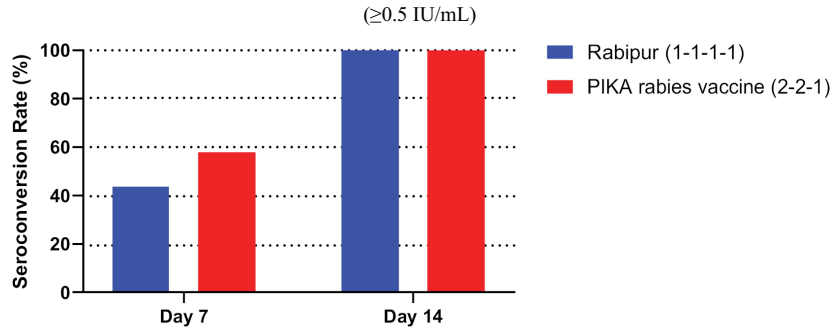

Significant difference between seroconversion rate was determined by Fisher’s exact test. There is no significant difference between the groups.

At the last visit day (day 42), the level of neutralizing antibody titer in PIKA rabies group was comparable to that of the control group. The follow table sets forth the levels of neutralizing antibody titer on day 42 in Phase II clinical trial in Singapore.

	Rabipur	PIKA Rabies Vaccine (2-2-1)
	mean ± standard deviation 95% confidence interval	mean ± standard deviation 95% confidence interval
Neutralizing antibody titer	19.16 ± 13.53 (15.69, 22.62)	21.59 ± 46.90 (9.15, 34.04)

The standard deviation of the neutralizing antibody titers in PIKA rabies vaccine arm appears to be wider due to one outlier which is beyond the upper test limit. The protection level of rabies vaccine is generally considered to be reached once neutralizing antibody titer reaches 0.5 IU/mL.

The accelerated regimen of PIKA rabies vaccine is advantageous to the standard Zagreb or Essen regimens because the standard regimens fail to induce higher and earlier seroconversion at day 7 post vaccination. Since the incubation period of rabies is approximately two or three months, YS Group’s future clinical studies will evaluate the neutralizing antibody titers beyond 42 days, up to six and 12 months, respectively, and YS Group will compare the antibody titers at different time points after vaccination between PIKA rabies vaccine and the commercialized rabies vaccines in comparison.

[Table of Contents](#)

Phase I Clinical Trials in China

To re-confirm the dosage and regimen selected in Singapore trial to apply to the population in China, a Phase I study was designed and is being conducted in China to evaluate the safety and immunogenicity of PIKA rabies vaccine administered at different dosage and various dosing regimen.

A total of 96 subjects were enrolled in Phase I clinical trial. Two dose levels, 0.5mL and 1.0mL of PIKA rabies vaccine were evaluated using 2-1-1 regimen given on day 0, 7 and 21 (approved regimen for the currently marketed rabies vaccine). Four different dosing regimens were evaluated, including 2-1-1 regimen given on day 0, 7 and 21, 2-1-1 regimen given on day 0, 3 and 7, 2-2-1 regimen given on day 0, 3 and 7, 2-2-1 regimen given on day 0, 2 and 7. The design of Phase I clinical trial includes (1) the primary safety and immunogenicity endpoints, and (2) the secondary endpoint of antibody level, seroconversion and cellular immunity. The primary safety endpoints include: (1) solicited adverse events collected seven days after each vaccination, (2) unsolicited adverse events collected 49 days after the first immunization, and (3) serious adverse events on throughout the study. The primary immunogenicity endpoint includes seroconversion rate at predefined time points post vaccination. The secondary endpoint is measured by the antibody titers at different time points post immunization.

Figure 7

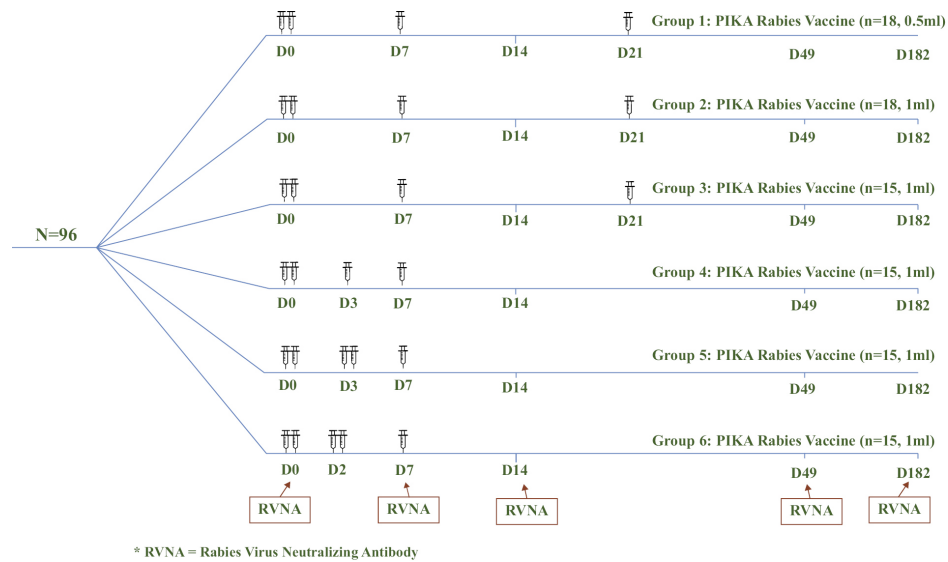

No safety concerns were revealed. No deaths and serious adverse events were reported. No vaccinerelated grade 3 adverse events were reported. The Phase I findings are consistent with those from Singapore trials and further demonstrates the capability of PIKA rabies vaccine of rapid and robust antibody response.

Preliminary results of Phase I study of PIKA rabies vaccine in China confirmed the dose, regimen and safety observed from the Singapore trials. The early seroconversion is clinically meaningful, given that in the event of grade 3 exposure without administration of immunoglobulin, early seroconversion is a principal indication of the early presence of protective neutralizing antibody in the blood.

Phase III Clinical Trial Plan in Southeast Asian Countries

A phase III, randomized, comparator-controlled, double-blind, multicenter study was designed to evaluate the immunogenicity, safety and lot to lot consistency of three lots of a PIKA Adjuvanted inactivated rabies vaccine in healthy adults using a post-exposure prophylaxis schedule. The clinical study will be a multicenter, multi-country trial in Singapore, Philippines and Pakistan, which started in the second half of 2023.

[Table of Contents](#)

Primary immunogenicity objectives of the study consist of demonstration of immunologic non-inferiority of PIKA rabies vaccine to the comparator Rabipur (or Rabipur equivalent) as measured by GMTs of RVNA and seroconversion rate differences at Day 14 and Day 28 and demonstration of lot-to-lot consistency of 3 production lots of PIKA rabies vaccine as measured by RVNA GMTs at Day 14. Co-primary safety objectives will include evaluation of all safety data collected from the study including changes in safety laboratory parameters from baseline. Secondary objectives include demonstration of immunological superiority of PIKA rabies vaccine to Rabipur as measured by seroconversion rate differences at Day 7 and evaluation of immune persistence of PIKA rabies vaccine as compared to the comparator vaccine.

In this study, a total of 4,500 subjects will be enrolled in the study randomized with 3,000 subjects allocated to PIKA rabies vaccine and 1,500 allocated to receive the comparator rabies vaccine Rabipur. The following table sets forth each class of subjects and the respective allocated study days of vaccination.

Figure 8

Treatment Allocation

Group	Vaccine	Regimen	Study Days of Vaccination					N
			0	3	7	14	28	
1	PIKA Rabies Vaccine lot#1	2-2-1	XX	XX	X	O	O	1000
2	PIKA Rabies Vaccine lot#2	2-2-1	XX	XX	X	O	O	1000
3	PIKA Rabies Vaccine lot#3	2-2-1	XX	XX	X	O	O	1000
4	Comparator	1-1-1-1-1	XO	XO	X	X	X	1500
Total								4500

PIKA Recombinant COVID-19 Vaccine (injectable)

YS Group began to develop in-house PIKA YS-SC2-010, also known as PIKA recombinant COVID-19 vaccine, in 2020. PIKA recombinant COVID-19 vaccine is being developed for the indication to have both prophylactic and therapeutic effects against COVID-19 disease caused by SARS-CoV-2, which is composed of YS Group's proprietary PIKA adjuvant and recombinant trimeric SARS-CoV-2 spike (S) protein subunit antigen (CHO cells). Preclinical studies results have demonstrated that PIKA recombinant COVID-19 vaccine achieved rapid, long-lasting and broad immune response against SARS-CoV-2. Compared with other COVID-19 vaccines with published data, PIKA COVID-19 vaccine can produce high-level antibodies 14 days after the initial immunization, while other vaccines generally need 3-6 weeks after the initial immunization to induce antibody production. By day 596 post prime vaccination, antibodies elicited by PIKA recombinant COVID-19 vaccine continued to effectively neutralize circulating variants SARS-CoV-2, including D614G, B.1.1.7 (Alpha), B.1.351 (Beta), P.1 (Gamma), B.1.617.2 (Delta) and B.1.1.529 (Omicron). Cynomolgus monkey study results also showed both prophylactic and therapeutic effects against SARS-CoV-2. PIKA YS-SC2-010 has exhibited significant inhibition against virus replication with important treatment effect. YS Group submitted the IND application for the prophylactic and therapeutic PIKA recombinant COVID-19 vaccine as a prophylactic vaccine to regulatory authorities of multiple jurisdictions, including Singapore, in 2021. YS Group completed Phase I trial of PIKA recombinant COVID-19 vaccine in the UAE in the first half of 2022 and the preliminary results showed that as basic immunization and sequential booster immunization, PIKA recombinant COVID-19 vaccines can induce the production of high-level neutralizing antibodies, which are effective for a variety of mutant strains, including Delta, Omicron sublineages BA.1, BA.2, BA.3, BA.4/5 and BA 2.12.1. In November 2022, YS Group obtained the clearance of IND for PIKA recombinant COVID-19 vaccine from FDA in the United States. YS Group has completed the enrollment of the multi-center multi-country Phase II/III clinical trials in the Philippines and UAE. The interim data analysis of Phase II study presented that the trial met both primary and secondary endpoints, measured by geometric mean titers (GMTs) of neutralizing antibody against Omicron virus and by seroconversion rates on Day 7 and Day 14 post a booster dose administration. YS Group is currently evaluating the involvement of COVID-19 pandemic and will make appropriate decision on the commercialization strategy in due course.

Mechanism of action

Historically, vaccine-induced protective immunity has been largely attributed to the function of antibodies, especially neutralizing antibodies that block the entry of the virus into target host cells and thus prevent infection. Due to their capabilities of providing immediate protection upon exposure, the elicitation of neutralizing antibodies has long been the primary goal of vaccination against many pathogens, including SARS-CoV-2. The immune responses to SARS-CoV-2 involve innate immune activation and antigen-specific responses of B and T cells.

PIKA recombinant COVID-19 vaccine's antigen component is a recombinant full-length, wild-type SARS-CoV-2 spike glycoprotein optimized in the established CHO expression system. The major target of neutralizing antibodies to SARS-CoV-2 is the S protein consisting of S1 and S2 domains. S1 is membrane distal and contains the receptor binding domain (RBD) that binds to the cellular receptor ACE2. S2 is membrane proximal and plays a role in membrane fusion. Antibodies binding to the S1 RBD can block interaction with ACE2 and antibodies binding to the S2 can inhibit conformation changes of the S protein and block membrane fusion. Therefore, the majority of COVID-19 vaccine candidates under preclinical and clinical development use the full-length S protein. To stabilize the full-length spike protein of SARS-CoV-2, YS Group made two modifications to the S protein sequence, including the modification of S1/S2 furin cleavage site 682-RRAR-685 to 682-GSAS-685 and the introduction of two proline substitutions at positions K986P and V987P.

PIKA recombinant COVID-19 vaccine contains PIKA adjuvant which is used to enhance and prolong both antibody and cellular immunity and ultimately provide durable protective effect. According to a recent challenge study in non-human primates, potent and durable neutralizing antibodies play an important protective role, and CD8+ T cell responses also contribute to protection especially when the antibody responses are suboptimal. In several late-stage clinical trials, S protein-based vaccines in mRNA and viral vector-based platforms have shown excellent preliminary vaccine efficacy against multiple SARS-COV-2 variants.

Market opportunities and competition

According to the WHO, there are 14 vaccines approved for use by WHO, NMPA, FDA or emergency approval, and 70 COVID-19 vaccines in clinical Phase III and above as of July 31, 2022. According to a study from John Hopkins University, herd immunity of COVID-19 could be achieved when 70% to 90% of the population acquire immunity. Assuming that an individual needs an average of two doses of COVID-19 vaccine to achieve immunity, a corresponding total of 10.5 to 13.5 billion doses and 2.0 to 2.5 billion doses of COVID-19 vaccines are required to achieve herd immunity globally and in China, respectively. On May 5, 2023, the head of the WHO declared "with great hope" an end to COVID-19 as public health emergency, stressing that it does not mean the disease is no longer a global threat. YS Group is currently evaluating the evolution of COVID-19 pandemic and will make appropriate decision on its commercialization strategies of PIKA COVID-19 vaccine.

WHO label	Pango lineage	GISAID clade/lineage	Nextstrain clade	Earliest documented samples	Date of designation
VOCs					
Alpha	B.1.1.7	GR/501Y.V1	20I (V1)	The United Kingdom, September 2020	December 18, 2020
Beta	B.1.351	GH/501Y.V2	20H (V2)	South Africa, May 2020	December 18, 2020
Gamma	P.1	GR/501Y.V3	20J (V3)	Brazil, November 2020	January 11, 2021
Delta	B.1.617.2	G/478K.V1	21A	India, October 2020	VOI: April 4, 2021 VOC: May 11, 2021
VOIs					
Epsilon	B.1.427/B.1.429	GH/452R.V1	21C	The U.S., March 2020	March 5, 2021
Zeta	P.2	GR/484K.V2	20B	Brazil, April 2020	March 17, 2021
Eta	B.1.525	G/484K.V3	21D	Multiple countries, December 2020	March 17, 2021
Theta	P.3	GR/1092K.V1	21E	Philippines, January 2021	March 24, 2021
Iota	B.1.526	GH/253G.V1	21F	The U.S., November 2020	March 24, 2021
Kappa	B.1.617.1	G/452R.V3	21B	India, October 2020	April 4, 2021
Lambda	C.37	GR/452Q.V1	20D	Peru, August 2020	June 14, 2021

- (1) A SARS-CoV-2 variant is a VOC if it meets the definition of a VOI and, through a comparative assessment, has been demonstrated to be associated with one or more of the following changes at a degree of global public health significance: (i) increase in transmissibility or detrimental change in COVID-19 epidemiology; or increase in virulence or change in clinical disease presentation; and/or (ii) decrease in effectiveness of public health and social measures or available diagnostics, vaccines and therapeutics.

[Table of Contents](#)

- (2) A SARS-CoV-2 isolate is a VOI if, compared to a reference isolate, its genome has mutations with established or suspected phenotypic implications, and either: (i) has been identified to cause community transmission/multiple COVID-19 cases/clusters, or has been detected in multiple countries; or (ii) is otherwise assessed to be a VOI by the WHO in consultation with the WHO SARS-CoV-2 Virus Evolution Working Group.

Source: the WHO, the F&S report

Advantages

PIKA recombinant COVID-19 vaccine is an innovative vaccine candidate against multiple SARS-CoV-2 variants. PIKA recombinant COVID-19 vaccine is composed of YS Group’s proprietary PIKA adjuvant and recombinant trimeric SARS-CoV-2 spike (S) protein subunit antigen (CHO cells). It is made by using genetically engineered recombinant CHO cells, which are cultured, harvested, concentrated and purified to obtain S-trimer protein designed according to the structure of S-protein of SARS-CoV-2 virus, and added with appropriate stabilizer and PIKA adjuvant. The production process of PIKA recombinant COVID-19 vaccine relies on mature genetic engineering technology of recombinant protein, which is highly scalable and poses low biosafety risk.

Preclinical studies results demonstrated that PIKA recombinant COVID-19 vaccine has rapid and efficient production of neutralizing antibody and cellular immunity to provide quick and sustained protection, with the titer of neutralizing antibodies against pseudovirus and wild-type SARS-CoV-2 virus induced by the vaccine being up to 10⁴, which shows a good immune effect. Moreover, the neutralizing antibodies induced by PIKA recombinant COVID-19 vaccine can persist for at least 596 days post-immunization, indicating good durability of the immune response. The results of prophylaxis animal challenge tests have shown that the PIKA recombinant COVID-19 vaccine could significantly inhibit virus replication and relieve the inflammation in the lungs. In addition, PIKA recombinant COVID-19 vaccine can significantly enhance the antigen-specific cellular immune response and convert the Th2-bias immune response to the Th1-bias immune response, decreasing the risk of antibody-dependent enhancement.

PIKA recombinant COVID-19 vaccine is effective against the currently prevalent mutant strains, in particular multiple virus variants of SARS-CoV-2, including D614G, B.1.1.7 (Alpha), B.1.351 (Beta), P.1 (Gamma), B.1.617.2 (Delta) and B.1.1.529 (Omicron). As indicated in Figure 13, neutralizing antibodies measured at day 14, 42, 98, 126, 182, 266, 364,406, 448, 518 and 596 post prime vaccination in New Zealand rabbit study demonstrated rapid, efficient, sustainable and high protection against multiple virus variants of SARS-CoV-2.

Figure 9. Neutralizing antibodies against multiple virus variants of SARS-CoV-2 in New Zealand rabbit study

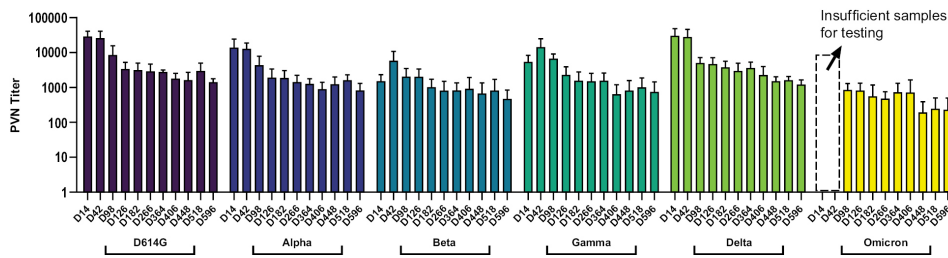

In terms of therapeutic effect, previous studies have shown that type I IFN response and T cell response may be crucial for the control and recovery of SARS-CoV-2 infection. Therefore, the rapid induction of SARS-CoV-2 specific T cell immune response in the early stage of infection may effectively alleviate the symptoms of COVID-19 patients and accelerate the recovery process. The results of cellular immune response demonstrated that PIKA recombinant COVID-19 vaccine can promote the early antigen-specific T cell immune response, which may play a role in alleviating the symptoms of COVID-19 patients and accelerating the recovery process. In a non-human primates study, vaccinated groups had significantly lower viral load than the control group, which indicates that vaccination using PIKA recombinant COVID-19 vaccine can significantly inhibit virus replication and demonstrates significant treatment effect. The results of therapeutic animal challenge tests have also demonstrated that recombinant COVID-19 vaccine could significantly reduce the viral load of the lung.

[Table of Contents](#)

Based on the results of YS Group's controlled animal studies (not head-to-head), YS Group observed that PIKA recombinant COVID-19 vaccine, once marketed, may have the following characteristics and advantages:

- *High level of neutralizing antibodies.* PIKA recombinant COVID-19 vaccine generated a high level of neutralizing antibodies. It has demonstrated a high level of neutralizing antibody activities against the SARS-CoV-2 virus as discussed above.
- *Sustainable antibody response.* PIKA recombinant COVID-19 vaccine generated sustainable neutralizing antibodies against the original virus strain and most of the currently prevalent mutant strains of the SARS-Cov-2 virus at post prime vaccination on day 14, 42, 98, 126, 182, 266, 364, 406, 448, 518 and 596.
- *Broad range of protection against mutant virus strains* PIKA recombinant COVID-19 vaccine demonstrated strong response to a broad range of mutant SARS-CoV-2 virus strains currently prevalent in the world, including but not limited to D614G, B.1.1.7 (Alpha), B.1.351 (Beta), P.1 (Gamma), B.1.617.2 (Delta) and B.1.1.529 (Omicron).
- *Rapid production of antibodies and protection against multiple SARS-COV-2 variants.* PIKA recombinant COVID-19 vaccine has the potential to be administered in two doses with a relatively short interval and enables the rapid and high production of antibodies, which is particular important during a highly transmissible infection.
- *Broad and balanced Th1, Th2 immune response* PIKA recombinant COVID-19 vaccine has the potential to generate strong CD4+ and CD8+ T-cell responses, which may provide protection especially in the case of weak antibody responses. Moreover, balanced Th1 and Th2 immune responses could be elicited by PIKA recombinant COVID-19 vaccine, which may decrease the risk of antibody dependent enhancement.
- *Unique therapeutic benefit.* PIKA recombinant COVID-19 vaccine exhibits promising treatment benefit in animal studies, which has the potential to become a therapeutic vaccine against the virus.
- *Versatile recombinant vaccine for mass production.* With a universal profile to induce stronger and broader range of sustainable and high neutralizing antibody response rate against existing and emerging variants, PIKA recombinant COVID-19 vaccine has the potential to achieve economy of scale which is considerably more suitable for mass production.
- *Favorable storage condition.* PIKA recombinant COVID-19 vaccine has the potential to be stored at a temperature between 2°C and 8°C, which is much higher and easier to achieve than that of other COVID-19 vaccines requiring lower storage temperatures.
- *Expanded coverage of vaccination.* Inclusion of PIKA has the potential to decrease the amount of spike protein antigen and expand the coverage of vaccination among the general population.

The results from preclinical studies and early stage clinical trials of PIKA recombinant COVID-19 vaccine may not be predictive of the results of later-stage clinical trials.

Summary of Preclinical Results

Full-length Spike Protein modification

The recombinant full-length spike protein is produced using CHO cell expressing system. It is the trimeric S protein that binds to the ACE2 receptor on host cells and mediates the entry of SARS-CoV-2 into the cells. To generate a stable prefusion S trimeric protein structure, several modifications were made, including (1) inserting fibritin foldon (Fd) domain of T4 bacteriophage fibritin protein at the C-terminal of the S protein, which can assist correct assembling

and folding of trimerization and stabilize the natural trimer conformation; (2) mutating the Furin restriction site between S1/S2 (RRAR to GSAS, 682-685) to obtain stable prefusion conformation; and (3) inserting two prolines (K986P and V987P) to make S protein more stable. The schematic representation of the structure is shown below.

Figure 10. Schematic Representation of S Trimeric Protein Structure

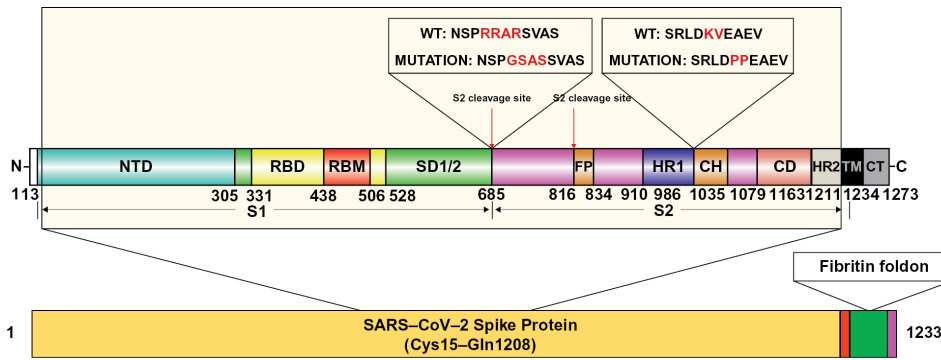

Antigen selection

To employ the best antigen for further development, YS Group produced three antigens, including fulllength S-Trimer protein, S1 domain protein, and RBD. YS Group immunized New Zealand rabbits intramuscularly with 6 ug of each antigen, with and without PIKA adjuvant for three times with one week apart.

The results demonstrated that antigen alone without PIKA adjuvant, regardless of the type of antigen, either failed to induce, or induced, modest level of neutralizing antibodies against pseudovirus. In contrast, antigen with PIKA adjuvant significantly enhanced the level of neutralizing antibodies. Among the three antigens, S-trimer performed the best in terms of neutralizing antibody production. YS Group also measured the level of neutralizing antibodies production against wild-type SARS-CoV-2 virus. S-Trimer with PIKA adjuvant elicited higher level of neutralizing antibodies than RBD with PIKA adjuvant.

Figure 11. Level of neutralizing antibodies against pseudovirus in New Zealand rabbits immunized with STrimer, S1 protein and RBD

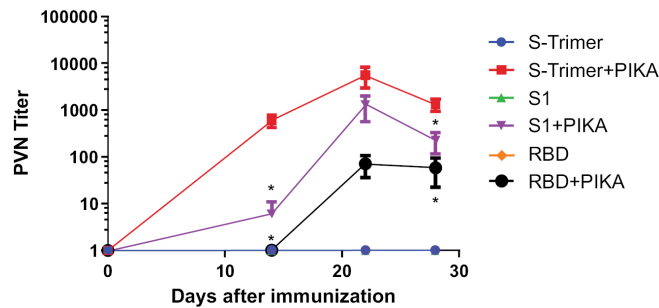

Data are shown as mean ± SEM. *p*-values were analyzed with a two-way ANOVA (vs. S -Trimer + PIKA, **p* < 0.05). There is no significant difference between the PIKA adjuvanted groups which were not marked at the same timepoint.

Pharmaceutical research is an evidence-based science aiming to apply scientific information retrieved from research experiments and to seek to assess the quality of research results, data or evidence relevant to the risks and benefits of individuals' characteristics or treatments. A statistic approach based on P-value is a common methodology in evaluating such research. A p-value, or probability value, is a number describing how likely it is that your data would have occurred by chance (i.e., that the null hypothesis is true). The level of statistical significance is often expressed

as a p-value between 0 and 1. The smaller the p-value, the stronger the evidence you should reject the null hypothesis. In terms of applying statistical science in the biomedical research, the p-value is the probability of obtaining a result at least as extreme as the one that was observed in the biological or clinical experiment or epidemiological study, given that the null hypothesis is true. The “P” value, frequently used to measure statistical significance, is the probability that the study results are due to chance rather than to a real treatment effect. Conventionally, $p < 0.05$ is referred as statistically significant and $p < 0.001$ as statistically highly significant. In medical research, p values less than 0.05 are often reported as statistically significant as it is wanted want there to be only a 5% or less probability that the treatment results, risk factor, or diagnostic results could be due to chance alone. Results that do not meet this threshold are generally interpreted as negative. There is no direct relevance of the statistical significance of such results to evidentiary standard of drug approval, as such statistical results were just a small component of decision-making process by the regulatory organization, and the drug approval process requires substantially more evidence from scientific research to comprehensive clinical studies to product manufacturing qualification measures.

Figure 12. Level of neutralizing antibodies against wild-type SARS-CoV-2 virus in New Zealand rabbits immunized with S-Trimer, S1 protein and RBD

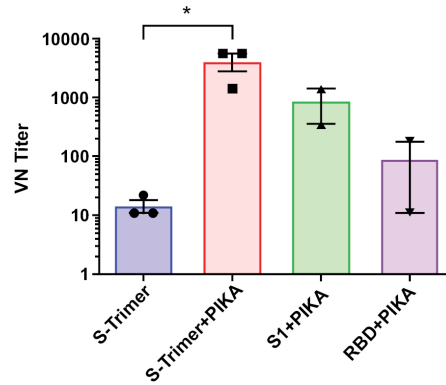

Data are shown as mean \pm SEM. p -values were analyzed with a one-way ANOVA ($* p < 0.05$). There is no significant difference between the groups not marked.

Dose exploration

As the next step, YS Group explored the different dose levels of Strimer with PIKA adjuvant and assessed the kinetic of neutralizing antibody against pseudovirus. Antigen alone even at the highest dose elicited modest level of antibodies. When PIKA adjuvant was added to S-trimer at dose level of 2.5 ug, 5 ug and 10 ug, all three elicited high levels of neutralizing antibodies, with the level of antibodies induced by 2.5 ug of S-trimer slightly lower and 5 ug and 10 ug of S-Trimer induced comparable level of antibodies.

Figure 13. Level of neutralizing antibodies against pseudovirus in New Zealand rabbits immunized with escalating dose of S-Trimer protein with or without PIKA adjuvant

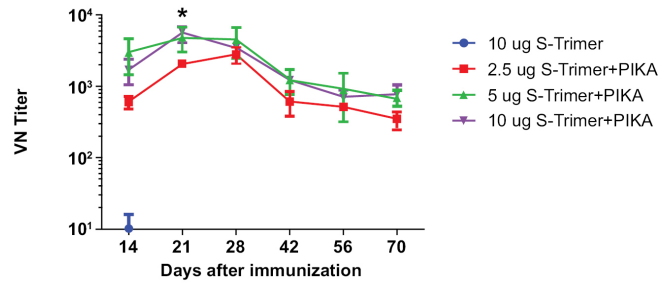

Data are shown as mean ± SEM. *p*-values were analyzed with a two-way ANOVA (2.5 µg of S-Trimer + PIKA compared with 10 µg S-Trimer + PIKA, **p* < 0.05). There is no significant difference between the PIKA adjuvanted groups which were not marked at the same timepoint.

Dosing schedule exploration

To optimize the dosing regimen, YS Group immunized New Zealand rabbits with 5 ug of S-Trimer and 1 mg of PIKA adjuvant using four different dosing schedules, including three two-dose regimens at day 0 and day 7, day 0 and day 14, and day 0 and day 21, and one three-dose regimen at day 0, day 7 and day 14. YS Group measured neutralizing antibodies against wild-type SARS-CoV-2 virus. The three-dose regimen at day 0-7-14 dosing schedule performed best while the three two-dose regimens elicited comparable level antibodies after day 42. The day 0-7 dosing schedule rapidly elicited high level of antibodies one week after the second dose, which could be advantageous as urgent control during the COVID-19 pandemic.

Figure 14. Level of neutralizing antibodies against wild-type SARS-CoV-2 virus in New Zealand rabbits immunized with S-Trimer with PIKA adjuvant at different dosing schedules

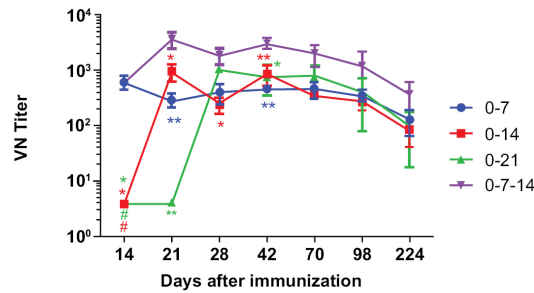

Data are shown as mean ± SEM. *P*-values were analyzed with a two-way ANOVA (vs. 0-7-14 group, **p* < 0.05, ***p* < 0.01; vs. 0-7 group, #*p* < 0.05).

Th1 and Th2 cellular immunity

Antibody dependent enhancement is a risk associated with COVID-19 vaccines. A Th2 dominant cellular immune response is considered contributing factor of antibody dependent enhancement. A balanced Th1/Th2 cellular immune response is preferred to Th1 cellular immune response to decrease the risk of antibody dependent enhancement. YS Group analyzed the T cells expressing Th1 and Th2 typed cytokines (IL2-vs. IL-4) by intracellular cytokine staining. The results suggest PIKA recombinant COVID-19 vaccine induced a balanced Th1 and Th2 cellular immune response.

Figure 15. T cells expressing Th1 (IFN γ , IL-2) and Th2 (IL-4, TNF) type cytokines in Balb/C mice immunized with S-Trimer with or without PIKA adjuvant on Days 0, 7 and 14

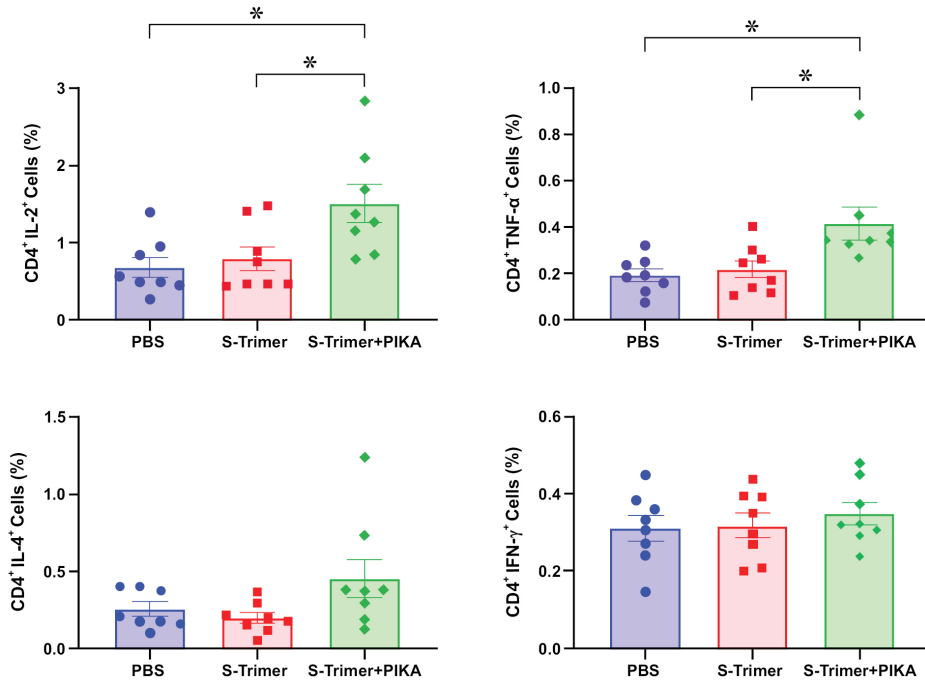

Data are shown as mean \pm SEM. p -values were analyzed with a one-way ANOVA (* $p < 0.05$). There is no significant difference between the groups not marked.

S-Trimer immunogenicity

PIKA adjuvant is superior to other types of adjuvants in augmenting S-Trimer immunogenicity. Groups of New Zealand rabbits were immunized on days 0 and 7 with 5 μ g S-Trimer in combination with different adjuvants including Alum, AddaSO3, Quil-adjuvant, and CpG. YS Group measured wild-type SARS-CoV-2 neutralizing antibodies 14 days after initial immunization. The results have indicated that PIKA performed best in terms of adjuvanting S-Trimer antigen.

Figure 16. Wild-type SARS-CoV-2 virus neutralizing antibodies in animal serum at day 14 post-immunization in New Zealand rabbits immunized with S-Trimer in combination with different adjuvants

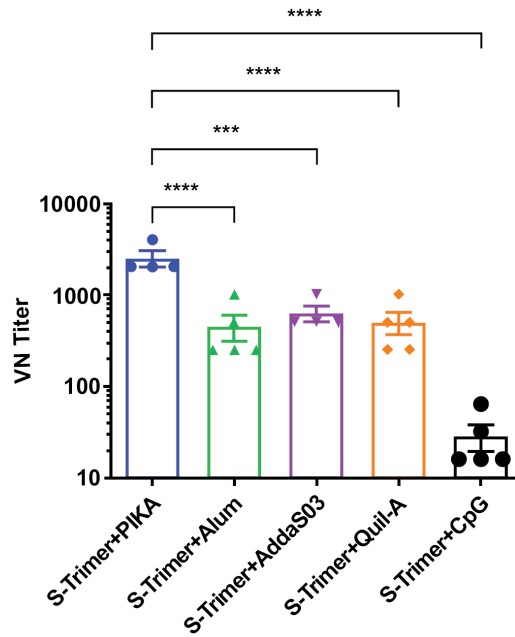

Data are shown as mean \pm SEM. p -values were analyzed with a one-way ANOVA (** $p < 0.001$, **** $p < 0.0001$). There is no significant difference between the groups not marked.

Protective activity

To demonstrate the protective activity of PIKA recombinant COVID-19 vaccine, 16 cynomolgus monkeys were randomly divided into four groups, among which the control group, the low-dose group and the high-dose group 1 adopted immunization regimen 0-7 (that is, immunized once each day on day 0 and day 7); while the high-dose group 2 adopted immunization regimen 0-7-14 (that is, immunized once each day on day 0, day 7 and day 14). All four treatment groups were challenge tested with COVID-19 (SARS-CoV-2) seven days after the last immunization. As indicated below, the result of the monkey study has shown that the three vaccinated groups had significantly lower viral load than the control group, which means that vaccination using PIKA recombinant COVID-19 vaccine can significantly inhibit virus replication and demonstrates good preventive effect. In addition, viral load decrease is correlated with the dose: the higher the antigen dose, the more times the monkeys receive immunization, and the further decrease in viral load.

Figure 17. COVID-19 viral load in the lungs of cynomolgus monkeys seven days after challenge

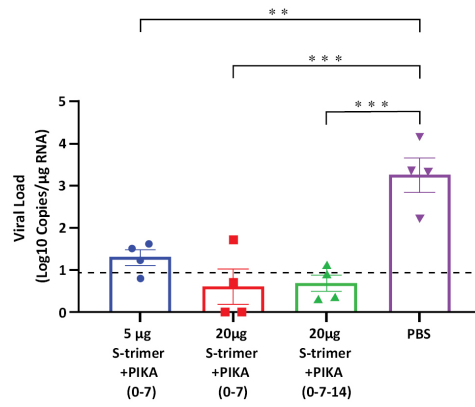

Data are shown as mean ± SEM. The horizontal dashed line indicates the limit of detection. Significance was calculated using one-way ANOVA (**p < 0.01; ***p < 0.001). There is no significant difference between the groups not marked.

Therapeutic activity

To demonstrate the therapeutic activity of PIKA recombinant COVID-19, 12 cynomolgus monkeys were randomly divided into three groups, including pre-exposure, post-exposure and controlled groups. The control group and the pre-exposure dosing group were dosed every day from the fifth day prior to the challenge, attacked with COVID 19 (SARS-CoV-2) after five days of consecutive dosing, and dosed for seven consecutive days since the day of the challenge. The post-exposure dosing group was not dosed prior to the challenge and only dosed since the day of the challenge for seven consecutive days. As indicated below, the post-exposure vaccinated group had significantly lower viral load than the control group, which indicates that vaccination using PIKA recombinant COVID-19 vaccine can significantly inhibit virus replication and demonstrates significant therapeutic effect.

Figure 18. COVID-19 viral load in the lungs of cynomolgus monkeys seven days after challenge

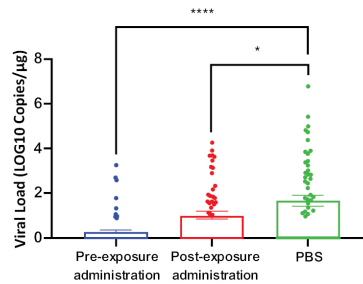

Data are shown as mean ± SEM. Significance was calculated using one-way ANOVA (*p < 0.05; ****p < 0.0001).

Phase I Clinical Trial in UAE

YS Group completed patient enrollment of Phase I trial of PIKA recombinant COVID-19 vaccine in the United Arab Emirates with preliminary results in the first half of 2022. Phase I clinical trial is designed to evaluate the safety, tolerability and immunogenicity of PIKA recombinant COVID-19 vaccine in healthy adults. This is a Phase I, open label, dose-escalation study of three dose levels of the SARS-CoV-2 spike antigen administered intramuscularly

(IM) in combination with a fixed dosage of PIKA adjuvant vaccine to evaluate the safety, tolerability, and immunogenicity of PIKA COVID-19 vaccine candidate in healthy individuals aged over 18 years. Three dose levels, namely 5 ug, 10 ug and 20 ug of recombinant spike protein with 1 mg PIKA, were administered via intramuscular injections. The study comprised of two arms. Arm A included subjects without history of COVID-19 vaccination and Arm B included subjects who will be receiving PIKA vaccine as a booster vaccination dose to those who had primary series of inactivated vaccines or mRNA vaccines. For Arm A, a total of 45 subjects were enrolled. Subjects in Group 1-3 received two doses of PIKA COVID-19 vaccine via IM administration on Days 0 and 7. For Arm B, a total of 90 subjects were enrolled and were further divided into Arm B1 (45 subjects) and Arm B2 (45 subjects). Arm B1 enrolled subjects who received COVID-19 inactivated vaccines as primary series and comprised of 15 subjects per dose (45 subjects). Arm B2 enrolled subjects who received mRNA vaccines as primary series and comprised of 15 subjects per dose (45 subjects). Subjects in Group 1-3 of Arm B1 and Arm B2 received one booster dose of PIKA COVID-19 vaccine via IM administration on Day 0. The primary endpoints included evaluation of safety as to solicited and unsolicited adverse events, serious adverse events, and adverse events of special interests; the secondary endpoints included evaluation of immunogenicity at GMTs and seroconversion rate differences of the neutralizing antibodies against the original strain and variants of concerns of SARS-CoV-2, and cell-mediated immune responses.

Figure 19

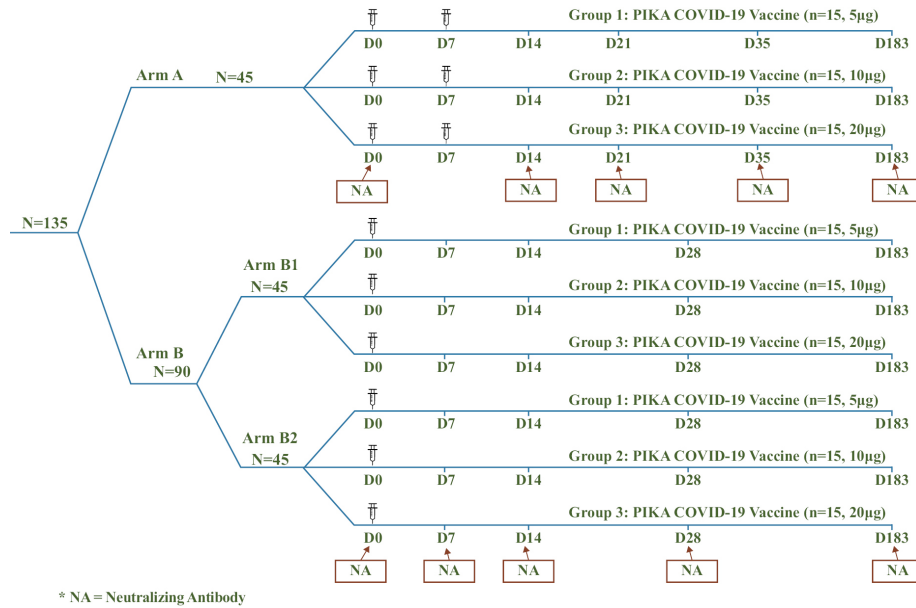
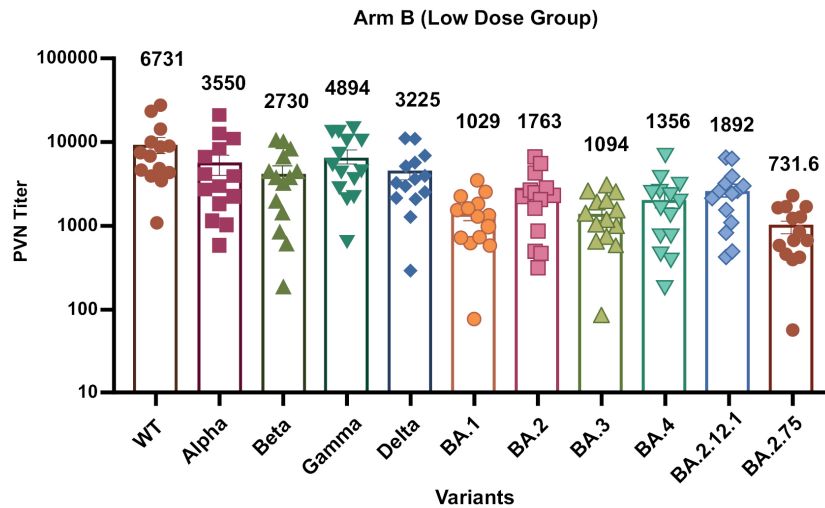

Figure 20. Schematic Diagram of Phase I Study Design

Arm	Subjects	Age	Regimen	Antigen Dosage	Sample Size
Arm A (Prime)	Subjects without history of COVID-19 vaccination	≥18 years	Two shots (Day 0,7)	5µg	15
				10µg	15
				20µg	15
Arm B (Booster)	Subjects who had completed the primary series of inactivated COVID-19 vaccination	≥18 years	One shot	5µg	15
				10µg	15
				20µg	15
	Subjects who had completed the primary series of mRNA COVID-19 vaccination	≥18 years	One shot	5µg	15
				10µg	15
				20µg	15

The clinical trial also evaluated the neutralizing antibody titers of Arm B (low dose group) for other SARS-CoV-2 variants. Immunogenicity testing 14 days after the booster dose demonstrated that the neutralizing antibody titer against BA.2 in the serum of the subjects in the low dose group of Arm B reached 1,763 and the titer against BA.4/5 was as high as 1,356. Whereas before vaccination, the neutralizing antibody titer against BA.2 and BA.4/5 in the same groups were 31.81 and 23.5 respectively.

Figure 21. Neutralizing antibody titer of PIKA COVID-19 vaccine (5 µg/dose) 14 days post vaccination (PVNT)



[Table of Contents](#)

Data are shown as mean ± SEM. Significance was calculated using one-way ANOVA, (vs. WT group, all other groups $p < 0.01$).

In the Phase I clinical trial, no safety concerns were revealed. No deaths and vaccinerelated serious adverse events were reported. Preliminary results of Phase I study of PIKA recombinant COVID-19 vaccine showed that as basic immunization and sequential booster immunization, PIKA recombinant COVID-19 vaccines can induce the production of high-level neutralizing antibodies, which are effective for a variety of mutant strains, including Delta, Omicron sublineages BA.1, BA.2, BA.3, BA.4/5 and BA 2.12.1.

Phase II and III Clinical Trials in the UAE and Philippines

A Phase II and III, Randomized, Double-blinded Study is designed to evaluate the Efficacy, Safety and Immunogenicity of a Booster Dose of PIKA-Adjuvanted Recombinant SARS-CoV-2 Spike (S) Protein Subunit Vaccine in Adults ≥ 18 Years Old Who Received 2 or more doses of Inactivated Covid-19 Vaccine.

Primary objectives in Phase II of the study are to assess the immunogenicity of PIKA COVID-19 vaccine 14 days after the booster dose and compare to the comparator inactivated COVID-19 vaccine. It is also aimed to demonstrate the immunogenic superiority of the PIKA COVID-19 vaccine on day 7 post booster dose. In Phase III trial, the efficacy and safety of PIKA COVID-19 vaccine in comparison to that of the comparator inactivated COVID-19 vaccine will be compared.

In Phase II, a total of 300 eligible subjects were allocated in a 1:1 ratio, stratified by age group (< 60 years old vs. ≥ 60 years old) to receive PIKA COVID-19 vaccine or the comparator inactivated COVID-19 vaccine. The ratio of the GMT of neutralizing antibody on Day 14 after the booster dose of PIKA COVID-19 vaccine group and inactivated COVID-19 vaccine group will be calculated. Among 300 subjects, at least 200 were enrolled as subset of long-term immunogenicity and 100 were enrolled as subset of early immunogenicity. Among the 100 early immunogenicity subsets, the ratio of the GMT of neutralizing antibody on Day 7 after the booster dose of PIKA COVID-19 vaccine group and inactivated COVID-19 vaccine group will be calculated.

Primary objectives in Phase III of the study are to assess the efficacy and safety of PIKA COVID-19 vaccine compared to the comparator inactivated COVID-19 vaccine. The secondary objectives in Phase III study are to assess the long-term safety and immunogenicity of PIKA COVID-19 vaccine compared to the comparator inactivated COVID-19 vaccine. In phase III, total 5,656 eligible subjects were randomly allocated in a 1:1 ratio to the PIKA COVID-19 vaccine group or the inactivated COVID-19 vaccine group, stratified by age group (< 60 years old vs. ≥ 60 years old). Among total subjects, at least 6% subjects were enrolled as subset of immunogenicity. Long term safety and immunogenicity will also be evaluated.

Figure 22. Study Design and Subject Allocation

Trial Design and Subject Allocation					
Phase	N	Immunogenicity Set	Vaccine	Vaccination	Blood Draws
II	150	Early: 50 Long Term: 100	PIKA COVID 19	Day 0	D0, 7, 14, 90, 180, 360
	150	Early: 50 Long Term: 100	Inactivated COVID 19	Day 0	
III	5656	6% of the subjects	PIKA COVID 19	Day 0	D0, 7, 14, 360
			Inactivated COVID 19	Day 0	
Total	5956				

[Table of Contents](#)

The interim data results from Phase II part of the Phase II/III head-to-head clinical study indicated PIKA COVID-19 vaccine generated a significantly higher geometric mean titers (GMTs) of neutralizing antibody against Omicron virus on both Day 7 and Day 14 after the booster dose compared with inactivated COVID-19 vaccine. In addition, similar immunogenicity superiority and statistical significance were also achieved by the measurements of GMTs of neutralizing antibody against wild type SARS-CoV-2 virus on both Day 7 and D14 after the booster dose compared with inactivated COVID-19 vaccine. These results further confirmed PIKA adjuvant's capability of accelerating human immune responses.

PIKA YS-HBV-001

PIKA YS-HBV-001 is a hepatitis B vaccine composed of genetically engineered recombinant hepatitis B surface antigen protein (HBsAg) and PIKA adjuvant, with the potential to become a hepatitis B vaccine with accelerated regimen. YS Group has completed the Phase I clinical trial of PIKA YS-HBV-001 in Singapore in 2017, which has demonstrated good reactogenicity and tolerability and immunogenicity under accelerated regimen.

Mechanism of action

HBV infection can cause morbidity and mortality, including acute hepatitis necrosis and chronic active hepatitis. Patients with chronic HBV infection are at higher risk of cirrhosis and hepatocellular cancer. A concentration of antibody against HBsAg 10 mIU/mL can confer protection against HBV infection. PIKA YS-HBV-001 can elicit high-level specific antibodies and robust and multifunctional cellular immune response to prevent HBV infection. PIKA adjuvant acts as an immunomodulating agent on innate immune receptors for sensing the presence of virus infection. Those receptors are expressed in dendritic cells (DCs), which are the most potent antigen presenting cells. When combining PIKA with HBsAg in PIKA YS-HBV-001, PIKA activates DCs to secrete interferon and cytokines, converts immature DCs to mature DCs for efficiently presenting HBsAg antigen to CD4+ T cells, and promotes T cell differentiation to functional helper T (Th) cells. Those helper T cells in turn provide multiple signals to B cells specific for HBsAg, generating antibody responses to provide protective immunity to HBV. Long-lived antibody response and T and B cell memory are able to provide persistent protection against HBV infection.

Market opportunity and competition

Hepatitis B is an infectious illness caused by HBV, which infects the liver and causes inflammation, scarring and, in some cases, liver cancer. The disease is a major health concern worldwide, particularly in Asia and Africa. Common prevention methods for HBV include HBV preventative vaccines, antiviral prophylaxis during pregnancy, screening of donated blood and HBV diagnosis.

According to the Global Hepatitis Report 2017 issued by the WHO, 257 million people, or 3.5% of the world population, were living with chronic HBV infection, and 0.9 million people died due to the complications of chronic HBV infections in 2015. In addition, certain chronic patients may develop cirrhosis, liver failure or hepatocellular cancer. An estimated 600,000 people die each year due to chronic consequences of HBV infection, such as cirrhosis and hepatocellular cancer, in addition to the approximate 40,000 deaths from the acute illness, according to the same source.

According to the F&S report, approximately 70.3 million people were infected with chronic HBV in China in 2021. This high prevalence of infection has prompted the Chinese government to increase its efforts in treating those suffering from chronic hepatitis B and strengthen its hepatitis B immunization program. In addition, the current diagnosis and treatment rate in China is relatively low at 32.1% and 21.1% in 2019, respectively. Lot release of hepatitis B prophylactic vaccine in China was 70.7 million in 2021, and is expected to reach 85.4 million in 2025 and further to 90.8 million in 2030, according to the same source.

YS Group believes PIKA YS-HBV-001 has advantages over current available hepatitis B vaccines in the market. See “— YS Group's Marketed Product and Product Candidates — YS Group's Clinical Stage Product Candidates — PIKA YS-HBV-001 — Advantages.” YS Group has completed the Phase I clinical trial of PIKA YS-HBV-001 in Singapore. YS Group plans to proceed with more advanced clinical studies in China and other countries. According to the NMPA and the F&S report, there were nine marketed hepatitis B prophylactic vaccine products in China as of December 31, 2021. According to the CDE and the F&S report, there were five hepatitis B prophylactic vaccine pipelines in China as of December 31, 2021.

Advantages

The major marketed prophylactic hepatitis B vaccine products in China contain a recombinant HBsAg with an aluminum salt, and are administered as a series of three doses over six months. Most adults who did not receive hepatitis B vaccination as an infant or adolescent may be at risk of being infected with HBV. However, the challenge of successful vaccination of adults against HBV remains, including poor adherence to a complete three-dose vaccination schedule over six months and low protective antibody production especially when the full course of vaccination cannot be achieved. The current hepatitis B vaccines have the following limitations:

- *Low protective antibodies.* The existing prophylactic hepatitis B vaccine failed to induce sufficient protective antibodies in some individuals. Certain patient cohorts are more susceptible to hepatitis B and do not respond well to standard vaccination programs. End-stage renal disease patients on hemodialysis have a higher prevalence of HBV infection and poorer prognosis than the general population. However, vaccination against HBV proposed for uremic patients or pre-transplant patients shows vaccine seroconversion rates significantly lower than immunocompetent individuals. Even at anti-hepatitis B antibody protective levels, this patient population has lower peak antibody titers and lower hepatitis B antibody levels as well as shorter duration of immunity.
- *Long-term and overall low success rates.* Current prophylactic hepatitis B vaccines for adults usually require three doses given over six months to provide seroconversion of approximately 30%, 70% and 90% after the first, second and third dose, respectively. The effectiveness of current vaccines is further compromised because many people fail to receive all three doses. Vaccine is less effective in patients that are already on dialysis and a protective anti-hepatitis B level develops in only approximately 55% of recipients when the 40 ug dose (double dose) regimen is used.

To overcome the limitations of the current vaccines, YS Group developed PIKA YS-HBV-001 to reduce regimen duration and confer comparable or better protection against HBV infection. Two doses of HBV-001 given within one month will also potentially improve the compliance and reduce the cost of immunization. In preclinical studies comparing vaccines of HBsAg, YS Group demonstrated that its PIKA-adjuvant PIKA YS-HBV-001 increased the production of HBsAg antibodies as compared with aluminum-adjuvant HBsAg vaccine. PIKA YS-HBV-001 enhanced T cell mediated immune response in mice, and was able to induce the production of IFN- γ secreting CD4⁺ and CD8⁺ T cells. The immune effect of PIKA YS-HBV-001 is superior to the existing non-adjuvant vaccine and alum- adjuvant vaccine. Moreover, PIKA YS -HBV-001 may realize multi-functional T cell induction. Phase I clinical studies have demonstrated that PIKA YS-HBV-001 has the potential to induce the production of multi-functional T cells in human, compared to Engerix, a marketed product, which primarily induced monofunctional T cells. The production of multi-functional T cells enables PIKA YS-HBV-001 to induce more robust and lasting T cell response, promote IFN and cytokine production and achieve accelerated and high seroconversion.

Summary of preclinical and clinical results

PIKA YS-HBV-001 completed the Phase I clinical trial in Singapore with 32 healthy naive adult subjects enrolled in the study.

Preclinical study

The results from Balb/c mice study comparing vaccines of HBsAg without adjuvant and vaccines with alum-adjuvant HBsAg indicated that PIKA YS-HBV-001 substantially increased HBsAg-specific IgG production in mice compared with those immunized with HBsAg alone or with HBsAg plus alum adjuvant ($p < 0.05$). In addition, YS-HBV-001 enhanced T cell mediated immune response in mice, and was able to induce the production of IFN- γ secreting CD4⁺ and CD8⁺ T cells. The immunogenicity of PIKA YS-HBV-001 was superior to the existing adjuvant-free vaccine and alum-adjuvant vaccine. PIKA YS-HBV-001 was well tolerated in rhesus monkeys and showed good immunogenicity.

Figure 23. IFN- γ Secreting T Cells by ELISpot after vaccination in mice

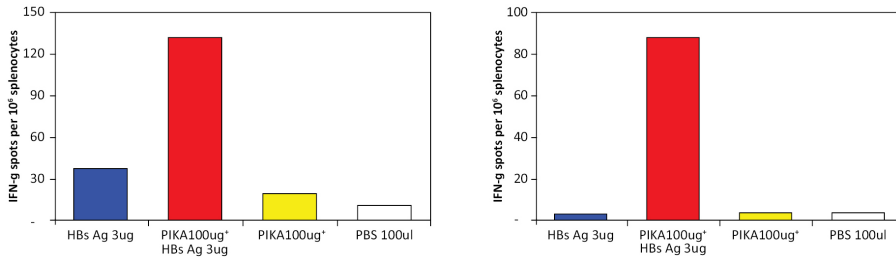
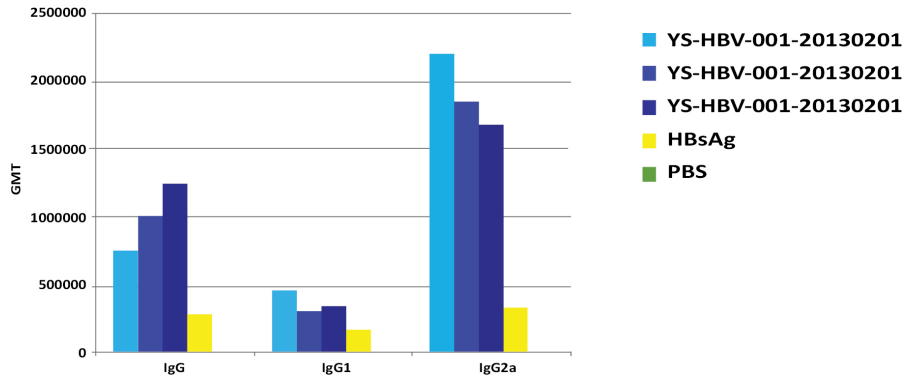

Figure 18. Anti-HBsAg antibody titers after vaccination in mice



Phase I clinical trial

The Phase I clinical trial of PIKA YS-HBV-001 was conducted in Singapore to evaluate the safety and immunogenicity of PIKA YS-HBV-001. This study was a randomized, double blind, active control and parallel group study with the enrollment of 32 healthy naive adult subjects aged from 21 to 65 years. Three groups were enrolled in this study, including (1) half dose (20 ug HBsAg) plus 500 ug PIKA dosed on days 0, 28 and 56; (2) normal dose (40 ug HBsAg) plus 1000 ug PIKA dosed on days 0, 28, and 56, and (3) an Engerix comparator, namely 20 ug HBsAg plus 500 ug alum dosed on days 0, 28 and 168. The study has shown that the seroconversion rate was comparable between shortened regimen of PIKA YS-HBV-001 and the standard regimen of commercially available vaccine (ENGERIX-B vaccine) in the control arm. No death and no vaccine-related serious adverse events were reported. No clinically meaningful changes were identified in biochemical, hematological, vital signs and physical examination. The data indicate that PIKA YS-HBV-001 has a good safety and tolerability profile. There was also indication that higher seroconversion could be induced earlier by PIKA YS-HBV-001 than ENGERIX-B vaccine. PIKA YS-HBV-001 was also able to induce a higher magnitude, more robust and lasting T cell response compared to ENGERIX-B vaccine. In particular, PIKA YS-HBV-001 at normal dose can induce multi-functional T cells, which are considered significant in clearing virus-infected cells. PIKA YS-HBV-001 has similar safety and tolerability as compared to the commercially available vaccine in the control arm. The following table sets forth the seroconversion rate at different time points after vaccination with PIKA YS-HBV-001 or ENGERIX-B.

Figure 24. Percentage of vaccines producing cytokines upon single peptide stimulation

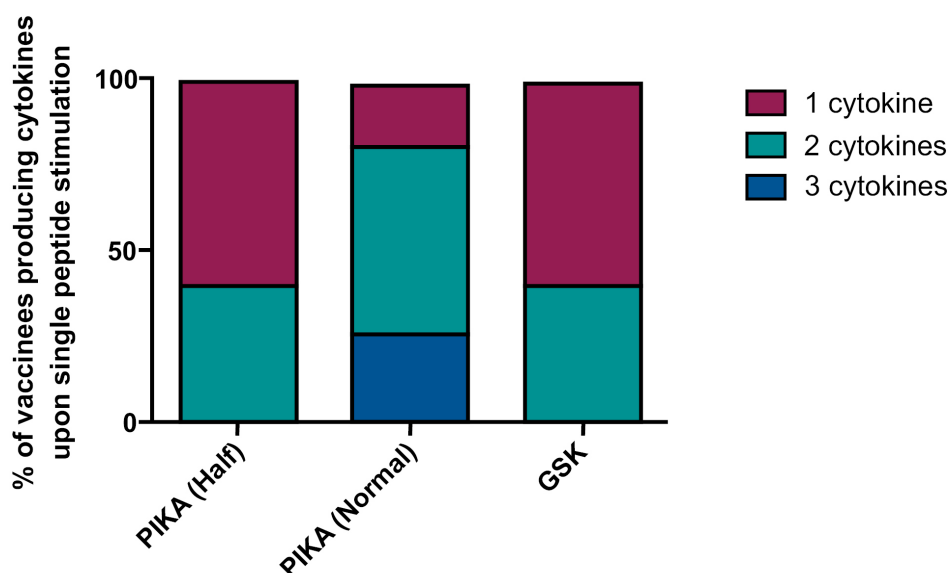

Visit (Day)	Seroconversion Rate (%)		High dose HBV-001	ENGERIX-B
	Low dose HBV-001	High dose HBV-001		
Baseline	0	0	0	0
D 56	87.5	100	100	66.7
D 84	90	100	100	66.7
D 196	90	100	100	88.9

PIKA YS-ON-001

PIKA YS-ON-001 is a multiple component complex of proteins and PIKA that can reduce the immunosuppressive effect of the tumor microenvironment and enhance the anti-tumor activity of the immune system against tumor cells. YS Group is currently independently developing PIKA YS-ON-001 as an immuno-oncology therapeutic. PIKA YS-ON-001 has demonstrated, in multiple animal models, strong antitumor activities as a standalone therapy and when combined with other therapeutic agents, such as kinase inhibitors, antibody blocking programmed death receptor-1 (PD-1) against a slew of advanced solid tumors, including hepatocellular cancer, breast cancer, lung cancer, colorectal cancer and prostate cancer. The U.S. FDA also granted PIKA YS -ON-001 two ODDs for the treatment of pancreatic cancer and hepatocellular cancer.

With respect to PIKA YS-ON-001, the Company commenced the cancer patient enrollment for the Phase I clinical study in China in December 2021, focusing on the safety study on late-stage breast cancer, lung cancer, liver cancer and melanoma subjects.

Mechanism of action

The effectiveness of immuno-oncology therapy often depends on the interaction of tumor cells with immune regulation within the tumor microenvironment. Under these interactions, the tumor microenvironment plays an important role in inhibiting or enhancing the immune response. YS Group believes that an effective immunotherapy against cancer requires multimodal approaches that target different aspects of the antitumor response (see Figure 6), such as tumor antigen recognition, T cell activation, NK cell activation and blockade of immune inhibitory pathways.

Figure 25. Multimodal approaches of cancer immunotherapy

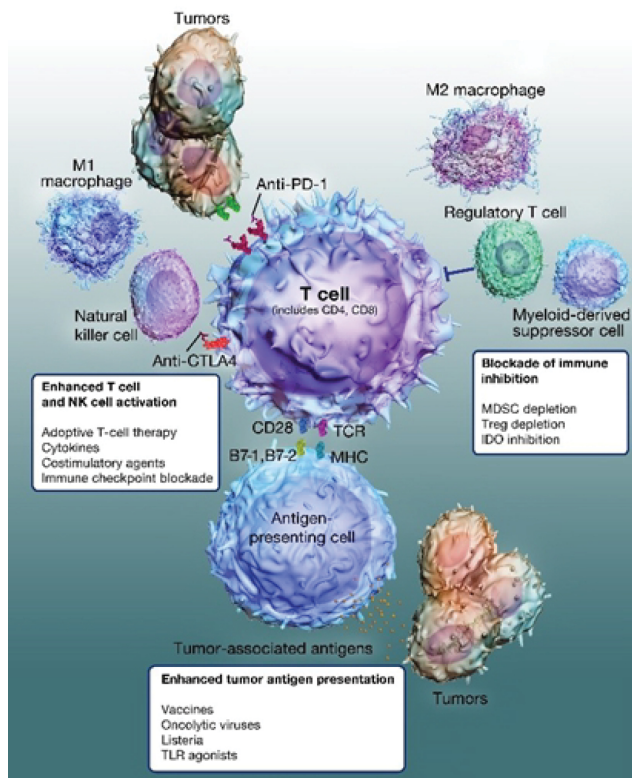

Anti-CTLA4: anti-cytotoxic T-Lymphocyte associated protein

MHC: major histocompatibility complex

TCR: T cell receptor

TAA: Tumor-associated antigen

Anti-PD-L1: anti-programmed death ligand 1

MDSC: myeloid derived suppressor cell

Treg: Regulatory T cells

M: Macrophage

PIKA YS-ON-001 is YS Group's proprietary immunotherapeutic agent based on the TLR3/RIG- I/MDA5 signaling pathway of PIKA immunomodulating technology. It can enhance the phagocytosis of macrophages, upregulate the activation of DC cells, NK cells and T cells, induce the production of multiple tumor-inhibitory cytokines and tumor cell apoptosis, and improve the host immune response. The effectiveness of immunoncology therapy often depends on the interaction of tumor cells with immune regulation within the tumor microenvironment. Under these interactions, the tumor microenvironment plays an important role in inhibiting or enhancing the immune response. YS Group believes that an ideal immunotherapy against cancer requires multimodal approaches that target different aspects of the antitumor response, such as tumor antigen recognition, T cell activation, NK cell activation and blockade of immune inhibitory pathways. Preclinical tumor microenvironment immune regulatory studies have shown that besides of increasing CD4+ and CD8+ T cell responses, PIKA YS-ON-001 can also significantly increase the proportion of NK and NKT cells in the tumor microenvironment. In several tumor models, PIKA YS-ON-001 can significantly reduce the number of Tregs in tumor microenvironment. At the same time, YS-ON-001 can reprogram tumor-associated macrophages (TAMs) from a protumor M2 phenotype to an antitumor M1 phenotype. The studies have indicated that YS-ON-001 could weaken the immunosuppressive effect of tumor microenvironment and enhance the killing function of immune system to tumor cells. With the multiple modes of action of PIKA YS-ON-001, YS Group believes PIKA YS-ON-001 has the potential to become an integral immunotherapy component with standard of care chemotherapies, targeted therapies and checkpoint inhibitors or with other emerging immunotherapies that produce additive or synergistic treatment benefits.

Figure 26. Frequency of immune cells in EMT-6, Hepa 1-6, and H22 tumors from mice*

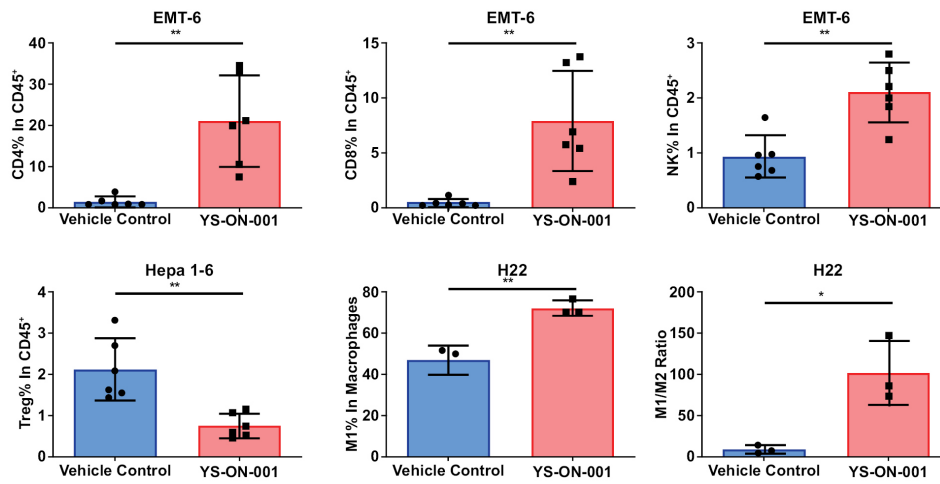

Data are shown as mean ± SEM. Significance was calculated using unpaired *t*-test (**p* < 0.05, ***p* < 0.01).

EMT-6: mouse breast cancer cell; Hepa 1-6: mouse liver cancer cell; H22: mouse liver cancer cell

Market opportunity and competition

Due to factors such as alcohol abuse, HBV and hepatitis C virus infections, the incidence of hepatocellular cancer in China increased from approximately 351,100 in 2017 to 388,000 in 2021, and is expected to reach 474,200 in 2030, according to the F&S report. The incidence of pancreatic cancer in China increased from approximately 101,500 in 2017 to approximately 115,900 in 2021, and is expected to reach approximately 155,800 in 2030, according to the same source. According to the WHO, the number of new cases is expected to rise by approximately 70% over the next two decades.

Immuno-oncology is a rapidly growing field in cancer treatment that focuses on modulating the immune system to stimulate or enhance anti-tumor activities to inhibit growth or eliminate tumors. Multiple strategies and technologies have been explored to enhance and prolong anti-tumor immune responses. Agents that inhibit two of these immune checkpoints, CTLA-4 and the PD-1/PD-L1 interaction, have recently been approved for a number of cancer indications. These checkpoint inhibitors represent a major advancement in cancer treatment, but a majority of patients fail to respond to these inhibitors used as single agents, which represents a significant opportunity to develop new immunotherapy with multiple immunomodulating functions in order to change the tumor microenvironment, enabling remission and durable control of tumor growth.

Emerging immunotherapies, such as checkpoint inhibitors, engineered T cells and therapeutic vaccines, will drive the market expansion of cancer treatment. The immuno-oncology market in China grew rapidly from RMB0.9 billion in 2017 to RMB16.3 billion in 2021 at a CAGR of 108.2%, and is projected to reach RMB63.8 billion in 2025 at a CAGR of 40.6% from 2021 to 2025, and further to RMB256.4 billion at a CAGR of 32.1% from 2025 to 2030, according to the F&S report. According to the F&S report, there were six immuno-oncology therapies targeting TLR3/MDA5/RIG-I globally as of July 31, 2022, and there had been no such therapy under development in China as of July 31, 2022.

Advantages

Current available immune-oncology therapeutic biologics in China and global markets mainly include monoclonal antibodies, bispecific antibodies, cytokines and therapeutic cancer vaccines, according to the F&S report. YS Group’s research has indicated that PIKA YS-ON-001 has the following potential advantages and benefits that differentiate it from currently available immuno-oncology therapeutic biologics:

- *Broad spectrum of anti-tumor activity.* Unlike PD-1 related checkpoint inhibitors, which tend to be more effective among patients with high PD-L1 expression on tumor cells, PIKA YS-ON-001 is a multi-target immuno-oncology drug and offers broad spectrum of anti-tumor activities, including hepatocellular cancer, lung cancer, breast cancer, colorectal cancer, prostate cancer, pancreatic cancer, lymphoma and melanoma. Figure 8 below (not head-to-head) represented the tumor growth inhibition (TGI) of multiple mice tumor models treated with PIKA YS-ON-001, anti-PD-1 or anti-PD-L1 antibodies. Treatment with PIKA YS-ON-001 significantly lowered the tumor weight and resulted in >50% inhibition rate, which was more efficient than anti-PD-1 or anti-PD-L1 antibodies. Figure 9 below showed enhanced anti-cancer activity of PIKA YS-ON-001 when in combination with anti-PD-1 antibody.

Figure 27. TGI of mouse tumor models treated with PIKA YS-ON-001, anti-PD-1 or anti-PD-L1

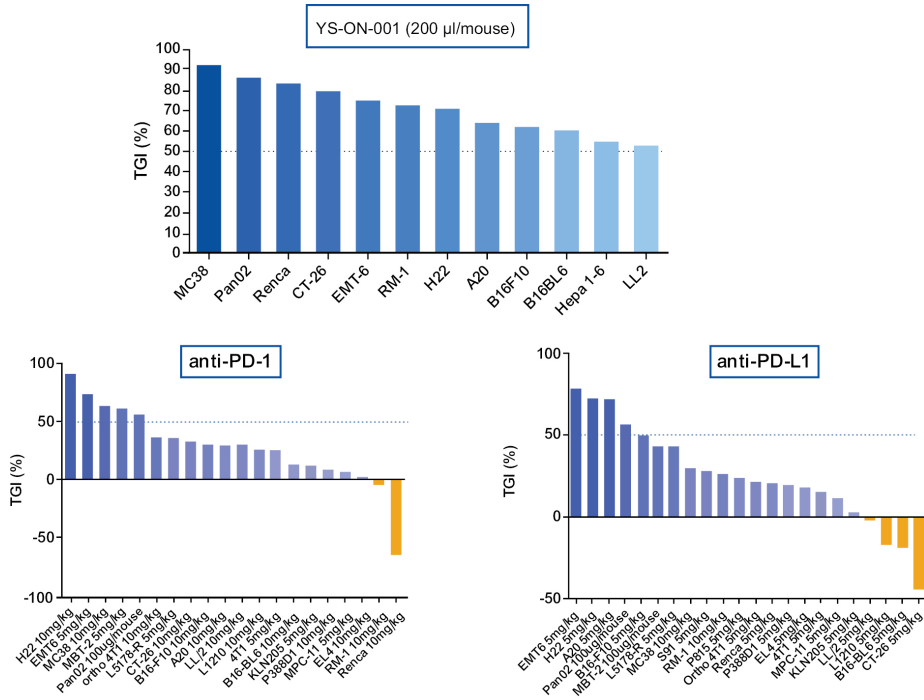
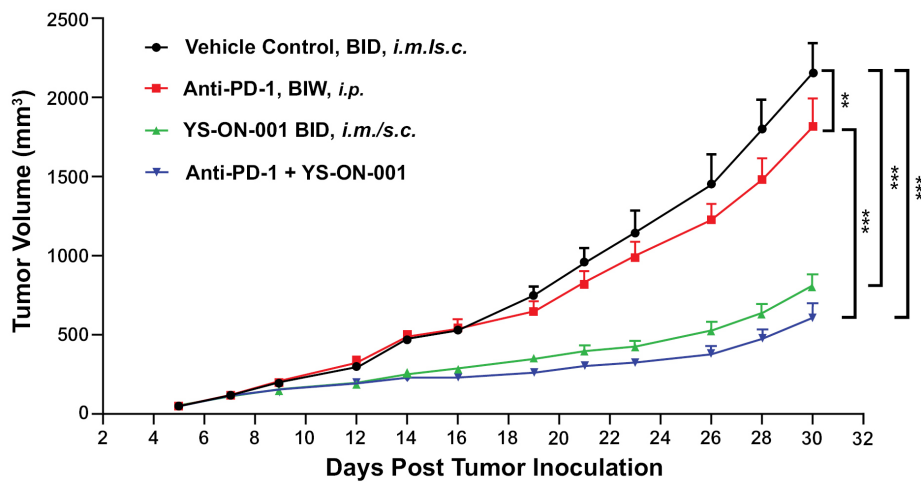

Figure 28. Enhanced anti-tumor activity of PIKA YS-ON-001 with anti-PD-1 antibody



Data are shown as mean ± SEM. P-values were analyzed with a two-way ANOVA (** $p < 0.005$, *** $p < 0.001$)

- *Potential to be used in combination with cancer therapies available in the market.*
 - (1) *Combination with radiotherapy (RT):* RT has been one of the three major traditional treatments for cancer patients to provoke important responses not only at the site of treatment but also on remote, non-irradiated tumor deposit, namely the abscopal effect. Radiation damaged cells can activate antigen presenting cells and induce maturation of dendritic cell to efficiently present tumor antigen to T cells. In combination with RT, PIKA YS-ON-001 has the potential to act as immune-modulator to enhance tumor specific immune response.
 - (2) *Combination with targeted therapies:* YS Group's study demonstrated that PIKA YS-ON-001 enhanced anti-cancer activity when combined with sorafenib, a multikinase inhibitor. YS Group believes PIKA YS-ON-001 has the potential to be combined with various targeted therapies.
 - (3) *Combination with checkpoint inhibitors:* PIKA YS-ON-001 can enhance the PD-L1 expression in tumor cells, which in most tumors are favored for PD-1 blockers to achieve high response rate. By combining PD-1 blockers, PIKA YS-ON-001 could enhance the therapeutic effect of PD-1 blocker, especially in those tumors that express no or low level of PD-L1 or are refractory to PD-1 blocker treatment.
 - (4) *Combination with oncolytic viruses:* Oncolytic virus therapy is emerging as a new approach in cancer treatment and oncolytic viruses are self-replicating, tumor selective and can directly lyse cancer cells. The damaged tumor cells could activate specific immune response to tumors which could be leveraged by PIKA YS-ON-001 to further enhance immune responses.
 - (5) *Combination with chemotherapies:* PIKA YS-ON-001 could also be combined with chemotherapy. Tumor antigen released from damaged tumor cells upon exposure to cytotoxic therapeutic agents can be captured by PIKA YS-ON-001 activated DCs and enhance the overall anti-tumor effects.
- *Potential to have better safety profile and marketability.* Adoptive cell-based immunotherapy, such as CAR-T and other in vitro modification of immunological cells, tends to have significant side effects, high level of technical complexity and difficulty in quality control and commercialization. Unlike these products, PIKA YS-ON-001 is expected to activate the patient's own cellular immune response by modulating tumor microenvironment. YS Group expects PIKA YS-ON-001 to have a better safety profile and marketability.

[Table of Contents](#)*Summary of preclinical and clinical results*

Preclinical results

The following table summarizes the preclinical study results of PIKA YS-ON-001's superior anti-tumor activities as compared to the standard cares of cancer treatment, measured by Treatment/Control (T/C)(%) and tumor inhibition rate (IR) of PIKA YS-ON-001 in advanced solid tumors animal models.

Animal Model	Agent	T/C (%)	IR (%)
Breast cancer 4T1 in-situ model	PIKA YS-ON-001	45.87	42.26
	Docetaxel	50.12	35.55
Lewis lung cancer LL/2 transplanted tumor model	PIKA YS-ON-001	37.02	60.88
	Cisplatin PIKA	47.46	42.38
	YS-ON-001+Cisplatin	28.38	75.44
Liver cancer H22 transplanted tumor model	PIKA YS-ON-001	18.84	73.40
	Sorafenib PIKA	36.79	53.73
	YS-ON-001+Sorafenib	12.56	88.19
Colon cancer CT-26 transplanted tumor model	PIKA YS-ON-001	5.38	97.71
	PD-1	53.66	47.05
Prostate cancer RM-1 transplanted tumor model	PIKA YS-ON-001	1.39	98.56
	PD-1	57.62	38.12
Melanoma B16-F10 Metastatic tumor model			

Phase I clinical trial

The Phase I clinical trial of PIKA YS-ON-001 is an open label, dose escalation and cohort expansion study in patients with advanced solid tumors. The objective of the Phase I clinical trial is to evaluate the safety and tolerability of YS-ON-001 in patients with advanced solid tumors who have limited available treatment options. Three dose levels were evaluated in a dose escalation fashion. YS Group commenced the cancer patient enrollment for the Phase I clinical study in China in December 2021, focusing on the safety study on late-stage breast, lung, liver and melanoma subjects. YS Group has completed Phase I clinical study in China in 2023.

YS Group's Preclinical Stage Product Candidates*PIKA YS-HBV-002*

PIKA YS-HBV-002 is being developed as an immune-therapy vaccine to treat chronic HBV infection, a significant unmet medical need worldwide. YS-HBV-001 contains PIKA adjuvant and HBV surface antigen, whose primary indication is the prevention of HBV infection. In contrast, PIKA YS-HBV-002 contains PIKA adjuvant and multiple HBV antigens, whose primary indication is the treatment of patients with chronic hepatitis B. Leveraging YS Group's proprietary PIKA immunomodulating technology in developing PIKA YS -HBV-001, PIKA YS-HBV-002 seeks to control and eliminate HBV from infected patients, which cannot be achieved through currently available anti-viral drugs. It is now widely accepted that to cure HBV, immune-based intervention will play an essential role in addition to the current antiviral approaches. The importance of T cells in establishing a functional cure of chronic HBV infection is a well-established concept based on human and animal data. HBV-specific T cells are quantitatively and functionally defective in CHB patients. The role of natural killer cells is also reported to play protective role in the

control of HBV replication. YS Group's PIKA immunomodulating technology has the potential to generate potent activators of both T and NK cells and a strong inducer of interferon production, which makes PIKA adjuvant suitable to be integrated into a therapeutic HBV vaccine. The following figure shows the preliminary anti-viral result of PIKA YS-HBV-002.

Figure 29. Decline in HBV DNA by HBV-002 in transgenic mice

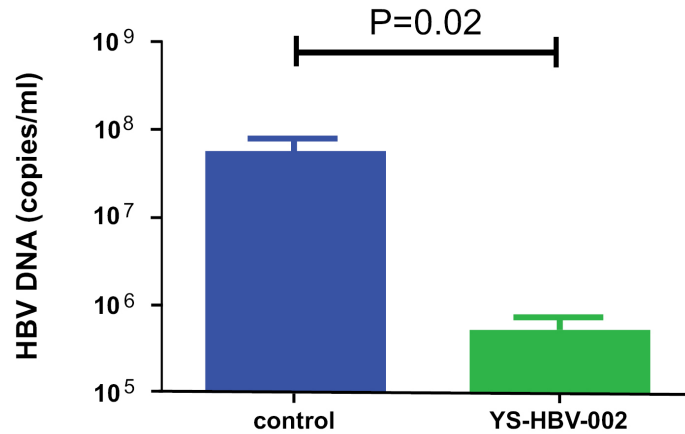

Data are shown as mean ± SEM. Significance was calculated using unpaired *t*-test.

According to the CDE and F&S report, the development of HBV therapeutic vaccine in China is at its nascent stage, and there was no marketed HBV therapeutic vaccine in China as of the date of this prospectus. There were six HBV therapeutic vaccine candidates in China as of July 31, 2022.

PIKA YS-ON-002

PIKA YS-ON-002 is being developed as another immune-oncology therapy based on YS Group's PIKA immunomodulating technology platform. Compared with PIKA YS-ON-001, which is a composition of PIKA agent with immunogenic protein-based antigens and other expedients, PIKA YS-ON-002 is a composition of PIKA agent, stabilization agent and other expedients. PIKA YS-ON-002 has a broad spectrum of anti-tumor activity against many tumor types, such as liver, colon, breast, lung, prostate, kidney, lymphoma and pancreatic cancer. YS Group believes that PIKA YS-ON-002 will have significant synergistic effect when combined with other treatment modalities such as chemotherapies, radiation therapies, checkpoint inhibitors and kinase inhibitors, leading to broad market opportunities.

PIKA YS-ON-002, when administered subcutaneously once a week, has demonstrated anti-tumor activities with a tumor growth inhibition of 76.42% against pancreatic cancer in a mouse model. When given at higher doses, PIKA YS-ON-002 completely eradicated established tumors, and some animals remained tumor free even after the cessation of PIKA YS-ON-002. The low dose of PIKA YS-ON-002 achieved 40% tumor free.

Figure 30. Anti-tumor effects of PIKA YS-ON-002 on subcutaneous Pan02 Murine Pancreatic Cancer Model

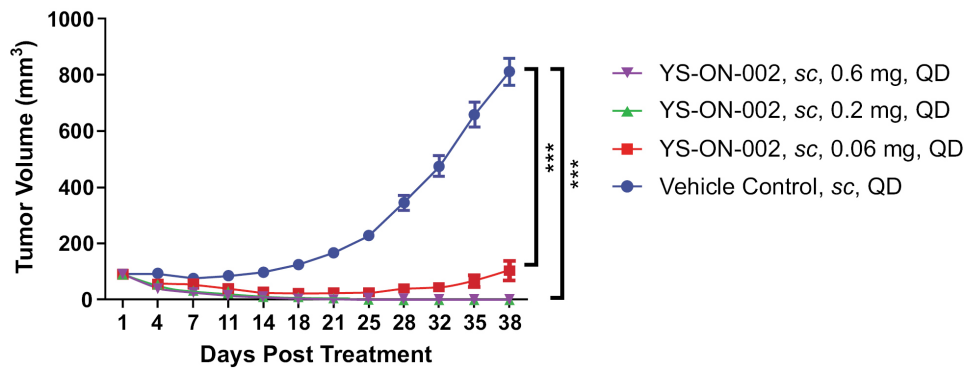

Data are shown as mean ± SEM. *P*-values were analyzed with a two-way ANOVA (***) $p < 0.001$

PIKA Influenza Vaccine

PIKA influenza vaccine is designed to contain quadrivalent seasonal inactivated influenza virus recommended by regulatory authorities regarding the annual seasonal vaccine. These inactivated influenza virus function as antigens which induce a humoral immune response, measured by hemagglutination inhibition (HI) antibody.

The addition of PIKA adjuvant may enhance the humoral and cellular immune responses. Specific levels of HI antibody titers induced by vaccination with recombinant HA protein vaccine have not been correlated with protection from influenza illness. In some human studies, HI antibody titers of 1:40 or greater have been associated with protection from influenza in up to 50% of subjects.

Antibodies against one influenza virus type or subtype confer limited or no protection against another. Furthermore, antibodies to one antigenic variant of influenza virus might not protect against a new antigenic variant of the same type or subtype. Frequent (usually annual) development of antigenic variants through antigenic drift is the virologic basis for seasonal epidemics and the reason for the usual replacement of one or more influenza virus strains in each year's influenza vaccine. Influenza vaccines are standardized to contain the hemagglutinins of influenza virus, representing the influenza viruses that are likely to be in circulation in the upcoming influenza season. Annual vaccination with the influenza vaccine is recommended because immunity during the year after vaccination declines, and circulating strains of influenza virus also change from year to year.

In a seasonal influenza mouse model, addition of PIKA was able to significantly enhance the antibody production via intranasal or subcutaneous administration of inactivated influenza vaccine, as compared to antigen alone. In an influenza virus challenge model, PIKA- adjuvanted influenza vaccine reduced the viral loads by 100-fold in the lungs, as compared to antigen alone. Antigen sparing effects by PIKA adjuvant were also demonstrated in a seasonal influenza mouse model that mixes PIKA with 0.015 ug of antigen dose which induced similar level of antibody responses to 1.5 ug antigen without adjuvant. In H5N1 pandemic influenza mouse model, PIKA- adjuvanted inactivated vaccine has demonstrated enhanced humoral immune responses and profound reduction of viral loads in the lungs. More importantly, using a lethal H7 influenza virus challenge model, mice vaccinated with inactivated H7N7 vaccine were completely protected against lethal challenge with H7N9 virus, which indicates clinical potential of the cross protection. In addition, with the potential of nasal application, PIKA influenza vaccines may have advantages compared to injectable-only vaccines such as better acceptance due to painless administration, additional protection by mucosal immunity and more user-friendly self-administration, especially during epidemics.

Figure 31. Pulmonary viral titer on day 5 post-infection in mice challenged with 50 PFU of PR8 intranasally three weeks after the boosting

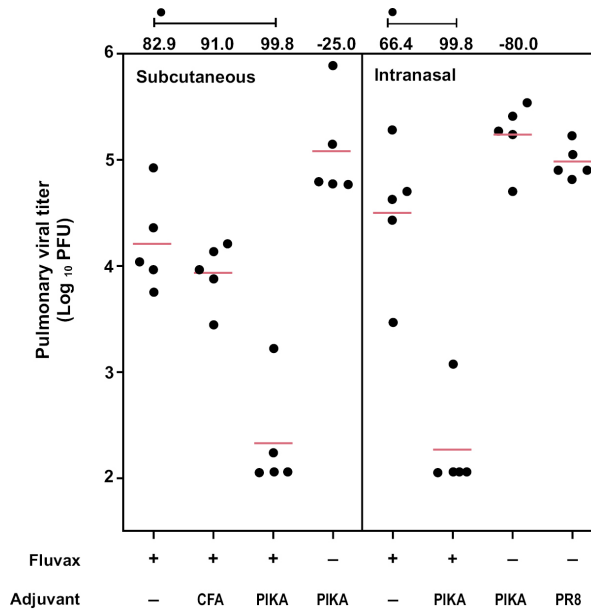

• p<0.05

PIKA Rabies Vaccine (Human diploid cell)

PIKA Rabies Vaccine (Human diploid cell) is designed and positioned as a new generation of rabies vaccine based on YS Group’s PIKA immunomodulating technology platform. Compared with PIKA Rabies

Vaccine currently at clinical stage, containing PIKA agent and inactive rabies virus antigen derived from Vero cell line, the antigen component of PIKA Rabies Vaccine (Human diploid Cell) is generated from human diploid cell line.

By leveraging the PIKA technology, YS Group believes that, compared to the existing rabies vaccine using human diploid cell in the market, PIKA Rabies Vaccine (Human diploid cell) has the potential to provide quick onset of immune response, lower dosage form and longer duration of protection and better safety advantages. YS Group expects to move this program into IND application in 2024.

YS GROUP’S STRATEGIC COLLABORATIONS

CEPI Clinical Research Collaboration

YS Group and Coalition for Epidemic Preparedness Innovations (“CEPI”) entered into a memorandum of agreement in June 2022 in relation to YS Group’s collaboration with CEPI for the clinical study of PIKA recombinant COVID-19 vaccine of YS Group where CEPI is providing technical expertise and laboratory testing support to YS Group for such studies. CEPI is a world leading organization missioned is to promote and strengthen public-private collaboration in order to develop, manufacture and stockpile vaccines necessary to respond to emerging infectious diseases and to support vaccine R&D in connection with public health emergencies. According to the memorandum of agreement, the cooperation will last for three years. CEPI will provide YS Group with sample testing services, including testing 900 samples for wild type virus neutralization and 180 samples for variant omicron BA.1. CEPI will pay the laboratory for the sample testing services for preclinical, phase I, phase II(a) samples from YS Group while YS Group will pay

[Table of Contents](#)

the laboratory for the sample testing services for phase II(b) and phase III samples, in addition to the shipping costs and customs fees. The memorandum of agreement does not affect the ownership of any IP rights in either party's background IP. YS Group shall exclusively own all IP of the test results and shall have the right to use it for any purposes.

Global Health Agreement with Adjuvant

YS Group entered into a global health agreement with Adjuvant Global Health Technology Fund, L.P. ("Adjuvant"), as amended, in connection with Adjuvant's investment of \$10.0 million in redeemable convertible preferred stock. Adjuvant is an investment fund formed for the charitable purpose of improving global health through the provision of financing to address global health challenges by supporting the development, production and commercialization of drugs, vaccines, medical devices, preventatives, diagnostics and other related technology targeting neglected infectious diseases and other global health conditions impacting low- and middle-income countries as defined by the World Bank. Pursuant to the agreement, YS Group undertook, with the funding support of \$10.0 million from Adjuvant, to, among others, apply such funds to develop and commercialize YSJA™ rabies vaccine in 31 low income and 47 lower-middle income countries as defined by the World Bank (the "Designated Markets"). YS Group agreed to use commercially reasonable efforts to pursue WHO prequalification to make the vaccine eligible for purchase and delivery by United Nation agencies and make the vaccine available in sufficient volume to both public and private purchasers in the Designated Markets with a reasonable tiered pricing framework, determined with reference to the type of buyer and the geographical location of such buyer. Alternatively, YS Group could satisfy the foregoing obligations by licensing or partnering with a third party that has the capabilities to develop and commercialize YSJA™ rabies vaccine in the Designated Markets. The obligation has a term of seven years and will be terminated prior to such term when and if YS Group has licensed or partnered with a third party to discharge such obligations with the prior consent of Adjuvant. YS Group also agreed to furnish certain periodical reports, including the use of the funding and the progress of the commercial objectives. If YS Biopharma fails to maintain compliance with these and other program-related investment commitments under such global health agreement, Adjuvant may be entitled to repayment for any portion of its investment that is not used for the purposes outlined in such agreement, the maximum amount of which is limited to Adjuvant's investment of \$10.0 million. As of the date of this prospectus, Adjuvant's investment has been fully utilized toward development of product pipelines as well as develop and commercialize YSJA™ rabies vaccines overseas. In the event of the assignment, sale, exclusive license, or other transfer of intellectual property related to YSJA™ rabies vaccines and related technology, YS Biopharma must ensure that the aforementioned commitments are expressly assumed by the purchaser, transferee, licensee, or acquirer. Upon the occurrence of certain events, including the failure, by YS Biopharma or any successor to prosecute related material intellectual property, to comply with the global health agreement, YS Biopharma agrees to grant Adjuvant a nonexclusive, irrevocable, non-terminable, fully-paid up, royalty free license (with the right to sublicense to third parties) to YSJA™ rabies vaccine to use, reproduce, modify, make, have made, distribute, sell and otherwise dispose of the product solely in the Designated Markets for the sole purpose of achieving the commitment under the global health agreement. The global health agreement has a term of seven years commencing from July 10, 2020, and may be terminated earlier if YS Biopharma, with the prior consent of Adjuvant, out-license to a third party with the capabilities to develop and commercialize YSJA™ rabies vaccine.

Research and Development

YS Group believes its commitment to the R&D of innovative products and technologies is fundamental to its success. YS Group takes pride in its PIKA immunomodulating technology, which has enabled a robust portfolio of product candidates. YS Group's R&D team focuses on the key functions of the R&D process; and YS Group's scientific advisory board provide critical guidance to its R&D efforts.

PIKA Immunomodulating Technology Platform

Overview

YS Group's PIKA immunomodulating technology targets toll-like receptor-3 (TLR3), retinoic acid inducible gene-1 (RIG-I), and melanoma differentiation-associated protein 5 (MDA 5), to activate the innate immune cells, such as antigen presenting cells and dendritic cells. The incorporation of YS Group's PIKA immunomodulating technology in its vaccines and therapeutic biologics achieved substantially enhanced immune responses as observed in both clinical and preclinical studies.

[Table of Contents](#)

Since YS Group acquired PIKA immunomodulating technology in 2010, YS Group has pursued in-house advancement of the PIKA technology in multiple fronts, including the following:

- *More in-depth understanding of the mechanism of action underlying the technology.* YS Group identified the capability of PIKA immunomodulating technology for T-cell activation in human clinical study, as well as the change of tumor cell micro-environment in the immuno-oncology field. YS Group's findings in the immuno-oncology area established the anti-tumor mechanism of action in PIKA adjuvant, which laid a theoretical foundation for the application of PIKA adjuvant in tumor immunotherapy.
- *Developed clinical applications and expanded protection of IP.* YS Group developed the application of PIKA adjuvant into multiple areas, including rabies vaccines, COVID-19 vaccines, prophylactic and therapeutic HBV vaccines and 33 immune-oncology. YS Group obtained patents for such relating to both vaccine and anti-cancer fields in multiple jurisdictions.
- *Large-scale manufacturing technology of PIKA adjuvants.* YS Group has established an automated process of PIKA synthesis with the scale of over 100 liter in size under the relevant GMP guidance, which is critical to the commercialization of PIKA-based vaccine and therapeutic candidates.

YS Group believes its PIKA immunomodulating technology has the potential to generate prophylactic and therapeutic vaccines. PIKA immunomodulating technology has already produced clinical stage candidates in four areas, including (1) PIKA rabies vaccine with significantly fast onset of seroconversion, ideally for three-visit one-week regimen to replace the existing five-visit one-month and three-visit three-week regimen, (2) emerging immune-oncology therapeutic biologics, including PIKA YS-ON-001 and PIKA YS-ON-002 with broad anti-cancer properties, (3) HBV interventions, PIKA YS-HBV-001, a new preventive vaccine targeting two-visit one-month regimen to replace the existing three-visit six-month regimen, and PIKA YS-HBV-002, a therapeutic product to treat chronic HBV infection, and (4) PIKA YS-SC2-010, also known as PIKA recombinant COVID-19 vaccine, a prophylactic and therapeutic vaccine against COVID-19 disease caused by SARS-CoV-2. See “— YS Group's Marketed Product and Product Candidates — YS Group's clinical stage product candidates” and “— YS Group's Marketed Product and Product Candidates — YS Group's preclinical stage product candidates.”

YS Group has obtained patents for its PIKA immunomodulating technology in more than 30 countries and regions. See “— Intellectual Property — Patents.”

In the United States, the NIH recognized the innovation and the potential of PIKA adjuvant in vaccine and other biologics fields and therefore has included PIKA adjuvant technology in the NIH vaccine adjuvant compendium, to promote scientific exchange and research collaboration around PIKA technology worldwide. The list includes scientific findings of PIKA adjuvant and data related to rabies virus, SARS-Cov-2 virus (recombinant protein), influenza A virus and hepatitis B virus.

Mechanism of actions

PIKA molecule is a class of double strand RNA (dsRNA) molecules of well-defined, specific ribonucleic acid units and molecular weight distribution synthesized with YS Group's proprietary technology. Endosomal dsRNA can be recognized by TLR3 while cytosolic dsRNA can be sensed by the retinoic acid-inducible gene (RIG) I-like receptor (RLR) family which include RIG-I and melanoma differentiation-associated protein 5 (MDA 5).

TLR3 is expressed primarily endosomal and in multiple cell and tissue types, including epithelial cells, muscle cells, certain neoplasms and antigen presenting cells; the RIG-I and MDA5 are ubiquitously expressed. Through TLR3, RIG-I and MDA5 signaling, PIKA can induce a prompt production of interferon, cytokines, chemokines and costimulatory factors. The anti-viral and anti-tumor effects of interferon have been well established and led to the U.S. FDA approval of several interferon-based products for antiviral and anti-tumor indications. In recent years, the U.S. FDA approved several TLR adjuvanted vaccines, including TLR4 based HPV vaccine (Cervarix) and zoster vaccine (Shingrix), and TLR9 based HBV vaccine (HEPLISAV-B). TLRs also attracted substantial interests in cancer research with emerging body of evidence indicating that strong innate and adaptive immune response induced by TLR activation could play a critical role in the cancer treatment. TLR based cancer monotherapy or combination therapies are currently in different phases of clinical development.

[Table of Contents](#)

Double-strand RNA stimulation can activate dendritic cells and upregulate the co-stimulatory and activation markers of dendritic cells such as CD86 and CD40. Dendritic cells play a critical role in innate and adaptive anti-viral and anti-tumor immune responses.

Protein-based vaccine without proper adjuvant is poorly presented by dendritic cells to CD8 T cells which are essential for anti-viral and anti-tumor effect. The production of type I interferon upon PIKA stimulation facilitates antigen cross presentation by dendritic cells and augment CD8 T cell and NK cell responses, which makes protein-based vaccines suitable for viral clearance and as well as anti-tumor indications. DsRNA is also found to activate NK cells through TLR-TICAM-1 pathway, and decrease both regulatory T cells and myeloid-derived suppressor cells, which also provide rationale for integrating PIKA in anti-viral and anti-cancer treatment.

TLR3 is expressed by sentinel cells of the innate immune system such as dendritic cells, natural killer cells, and macrophages, and by nonimmune cells including epithelial cells, fibroblasts, and endothelial cells. TLR3 localizes to the endosomes where it senses viral and host-derived nucleic acids and initiates inflammatory pathways, activating the innate immune response and establishing an antiviral state to prevent viral replication. Its expression modulates rapidly in response to pathogens, various cytokines, and environmental stress.

TLR3 expression on immune cells has been widely exploited to promote an anti-tumor immune response, and various TLR3 agonists have been investigated in clinical trials for their anti-tumor immunity. The anti-tumor responses that are induced by TLR3 agonists are attributed to their capability to stimulate APCs, such as DCs, which in turn activate tumor specific T cell responses and to their capacity to switch the phenotype of myeloid suppressor cells and tumor associated macrophages from immunosuppressive to immunosupportive.

TLR3 signaling can also occur on nonimmune cells, contributing to an anti-tumor response. Many types of cancer express TLR3, including breast cancer, oral cell squamous and esophageal cancer, cervical cancer, ovarian cancer, prostate cancer, head and neck cancer, hepatocellular cancer and melanoma. Cancer cells respond to TLR3 ligands by secreting inflammatory cytokines, type I interferon, and chemokines, which enhance the recruitment and activation of immune cells.

Moreover, TLR3 agonists are found to promote the direct inhibition of tumor growth in vitro in several mouse and human cancer cell models through two mechanisms: decreasing proliferation and inducing apoptotic cell death.

Scientific advisory board

YS Group's scientific advisory board, established in 2011, plays an active role in the review of YS Group's biopharmaceutical product development programs. YS Group also seeks advice from its scientific advisory board on R&D strategy and technical matters.

Yunde Hou, M.D., Ph. D., is an academican of the Chinese Academy of Engineering and is currently the Director of the Academican Laboratory of the National Institute of Viral Disease Control and Prevention under the national CDC in China, as well as the Chief Technological Officer of National Science and Technology Major Project for Viral Diseases. He was founder and former Chairman of the Chinese Society of Virology and was one of the two laureates for the 2017 China's National Preeminent Science and Technology Award, the highest scientific award in China. Dr. Hou is also the former Dean of the Institute of Virology, the Chinese Academy of Preventive Medicine, and former Vice President of the Chinese Academy of Engineering. Dr. Hou is the leader of recombinant interferon and many genetically engineered drugs. He was the first person in China that isolated para-influenza viruses I, III and IV. He developed preventive and therapeutic licensed biological products. Dr. Hou received a B.S. in medicine from Tongji University and a Ph.D. in medical sciences from the Iwanowski Virus Research Institute of the former Soviet Union.

Mr. Yongxin Yu is an academican of the Chinese Academy of Engineering and is currently the Chief Vaccine Expert of the National Institutes for Food and Drug Control. As a leader in vaccinology and virology in China. Mr. Yu has nearly 60 years of experience in the R&D of vaccines and has been widely recognized for his contributions to the quality control and research of vaccines for diseases such as Japanese encephalitis and rabies. From the 1950s to the 1980s, he led the development of the SA14-14-2 strain for the Japanese encephalitis live attenuated vaccine, which was the first live attenuated vaccine against Japanese encephalitis in the world and has fundamentally suppressed the viral spread in China since its mass adoption. He also chaired the strain selection and cultivation relating to primary

[Table of Contents](#)

hamster kidney cell rabies vaccine in China, which improved the safety and efficacy profile compared with previous rabies vaccine then available in China. Mr. Yu has authored or co-authored numerous articles and books and currently serves on the editorial boards of several peer-reviewed journals.

Mann Fung, M.D. is the chief executive officer of Tavotek Biotherapeutics, a biopharmaceutical company focused on medicines for cancers and autoimmune diseases. He was a former Vice President of Johnson & Johnson, where he led the development and strategies on innovative oncology therapies in the Asia-Pacific region. Prior to that, he served as Vice President for the R&D of innovative antitumor drugs and 36 immune-oncology therapeutics at the U.S. headquarters of Johnson & Johnson, during which he was noted for leading the development of Ibrutinib, an internationally recognized potent inhibitor of Bruton's tyrosine kinase. Dr. Fung also served at several positions at Eli Lilly and Company, including as Head of Oncology and Critical Care Products for Lilly Japan. Dr. Fung is a fellow of American College of Physicians and also a scientific advisory board member of Virogin Biotech. Dr. Fung obtained his M.D. degrees from the University of Utah. He also obtained a master's degree in health care management from Harvard University.

Guang Gao, Ph.D. is the senior technical officer at Shanghai Representative Office of PATH, an international non-profit organization to develop and deliver lifesaving vaccines to women, children, and communities around the globe. Dr. Gao has distinguished expertise in advising PATH partners in China and working with vaccine manufacturers in China to improve their quality system and manufacturing capability to bring their products to domestic and global markets. She has extensive experience in the fields of GMP manufacturing regulation, regulatory inspection, review and approval of vaccines and biological products in China and the United States. During her tenure at the FDA China office, she provided authoritative guidance and consultations regarding regulatory inspections and investigations and worked directly with the Chinese government for public health system evaluations. Prior to that, Dr. Gao served multiple positions at the Center for Biologics Evaluation and Research of the FDA, including as a national authoritative regulatory review scientist to provide technical leadership and guidance for regulatory activities. Dr. Gao has obtained the Regulatory Affairs Certification accredited by the Regulatory Affairs Certification Board and the Certified Quality Auditor Certification accredited by the American Society for Quality. Dr. Gao also published numerous papers on peer-reviewed scientific journals. Dr. Gao received her Ph.D. degree in biochemistry from Nanjing University.

Research and development team and activities

In-house research and development team and activities

As YS Group engaged in both the manufacturing of YSJA™ rabies vaccine and the continuous exploration of its PIKA-based candidate pipeline, YS Group's R&D efforts span from those relating to its marketed product, in particular those relating to manufacturing technologies and quality assurance and control, to those relating its product candidates, such as PIKA adjuvant and relevant products.

YS Group's R&D team consisted of 181 employees as of September 30, 2023, representing 24% of its total employees. YS Group's R&D team is located in Beijing, Shenyang (China), Maryland (the United States) and Singapore and is involved in different stages of the R&D process relating to YS Group's marketed product and product candidates, such as preclinical studies, clinical trials, regulatory filings and process development. YS Group's core R&D staff also specialize in different aspects of YS Group's R&D initiatives, which consist of preclinical team, clinical team, regulatory filling team and intellectual property team. In addition, YS Group's quality management staff in Shenyang also supports YS Group's R&D by performing the related quality assurance and control activities.

YS Group's preclinical team is responsible for proof-of-concept, preclinical evaluation, establishment of manufacturing processes and formulation, quality research and method development. YS Group's preclinical team is further divided into different R&D focuses, such as project, platform and culture collection, PIKA adjuvant, bioreactor and technology development. YS Group's clinical team is primarily responsible for performing clinical trial study design and management. YS Group's regulatory filing team is primarily responsible for vaccines and biologics approval process and monitoring YS Group's R&D projects to ensure their compliance with relevant regulations. YS Group's intellectual property team is primarily responsible for patent and trademark application and maintenance, and they thoroughly communicate with technicians to conduct intellectual property retrieval and analysis.

Outsourced research and development activities

In line with industry practice, YS Group outsources certain testing activities related to R&D to independent CROs. See “— CROs” for details. YS Group cooperates with reputable organizations and institutions with respect to its outsourced R&D activities, which provide important access to human subjects and professional testing and clinical trial services. For instance, YS Group cooperates with certain active hospital units in Singapore, which are operated under stringent standards and high efficiency, providing on-site support to investigators as well as safety, security and reassurance for study volunteers. YS Group also cooperates with reputable institutions in China such as CDC, the Institute of Microbiology of the Chinese Academy of Sciences (IMCAS), the Kunming Institute of Zoology of the Chinese Academy of Sciences (KIZ) and the Institute of Laboratory Animal Science, Chinese Academy of Medical Sciences & Peking Union Medical College (CAMS&PUMC).

Research facilities

YS Group has established four R&D sites located in Maryland (the United States), Singapore, Beijing and Shenyang (China). YS Group strategically allocates its R&D activities in different regions according to their respective advantages and resources. For example, YS Group primarily carry out its late-stage R&D activities relating to PIKA rabies vaccine in Shenyang facilities, leveraging its in-depth experience in pilot and large scale of manufacturing functions.

Intellectual Property

YS Group’s intellectual property and proprietary technology are important to its success. YS Group relies primarily on a combination of patent, trademark and trade secret protection laws as well as employee confidentiality agreements to safeguard and protect YS Group’s intellectual property rights and knowledge as well as YS Group’s brand. YS Group’s ability to protect and use its intellectual property rights in the continued development and commercialization of YS Group’s technologies and products, operate without infringing upon the proprietary rights of others, and prevent others from infringing YS Group’s proprietary rights, is also crucial to YS Group’s continued success. YS Group will protect its products and technologies from unauthorized use by third parties only to the extent that they are covered by valid and enforceable patents, trademarks or copyrights, or are effectively maintained as trade secrets, knowledge or other proprietary information. With respect to, among other things, proprietary knowledge that is not patentable and processes for which patents are difficult to enforce, YS Group relies on trade secret protection and confidentiality agreements (or confidentiality provisions in employment contracts) to safeguard YS Group’s interests. YS Group believes many elements of its products, clinical trial data and manufacturing processes involve proprietary knowledge, technology or data that are not covered by patents or patent applications. YS Group has taken appropriate security measures to protect these elements. In particular, YS Group has entered into confidentiality, non-compete and invention assignment agreements with its executive officers and R&D personnel. These agreements address intellectual property protection issues and require the employees to assign to YS Group all of the inventions, designs and technologies they develop during their terms of employment and cooperate with YS Group to secure patent protection for these inventions if YS Group wishes to pursue such protection. Any of these parties may breach the agreements and disclose YS Group’s confidential information or YS Group’s competitors might learn of the information in some other way. If any of YS Group’s trade secrets, knowledge or other proprietary information that is not protected by a patent were to be disclosed to or independently developed by a competitor, YS Group’s business, results of operations and financial condition could be materially and adversely affected. Despite any measures YS Group may take to protect its intellectual property, no assurance can be made that unauthorized parties will not attempt to copy aspects of YS Group’s products or manufacturing processes or YS Group’s proprietary technology, or to obtain and use information that YS Group regards as proprietary. See “Risk Factors — Risks Related to YS Group’s Intellectual Property.”

Patents

YS Group actively seeks for its PIKA immunomodulating technology and product candidates embodying the technology, and consider on a case-by-case basis filing patent applications with a view to protecting certain innovative products, processes, and methods of treatment (or other equivalents in certain jurisdictions). As of the date of this prospectus, Singapore Yisheng is the proprietary owner of a vast majority of YS Group’s patents owning about

[Table of Contents](#)

70 patents in over 30 countries and the term of individual patents may vary based on the countries in which they are obtained. The patent portfolios for YS Group's PIKA immunomodulating technology and major clinical stage product candidates as of the date of this prospectus are summarized below.

Product/ technology	Patent name	Owner/ applicant	Jurisdiction	Patent status ⁽¹⁾	Patent expiration	Type of patent
PIKA adjuvant	Polyinosinic acid- polycytidylic acid-based adjuvant	Singapore Yisheng	Australia, Brazil, Canada, Cuba, the European Union, Austria, Belgium, Switzerland, Denmark, France, the United Kingdom, Ireland, Italy, Netherlands, Poland, Turkey, Spain, Sweden, Germany, Indonesia, Israel, India, South Korea, Malaysia, New Zealand, the Philippines, Russia, Singapore, Thailand, Taiwan (China), the United States, Vietnam, South Africa the United States, Mexico	Granted	2025 to 2027	Composition of matter
		Singapore Yisheng	The United States, Mexico	Granted	2025	
	Immunogenic substances comprising a polyinosinic acid- polycytidylic acid-based adjuvant	Singapore Yisheng	China, Australia, Cuba, Indonesia, India, Mexico, Malaysia, New Zealand, the Philippines, Russia, Singapore, Taiwan (China), the United States, Vietnam, South Africa	Granted	2026 to 2028	Composition of matter
		Singapore Yisheng	Australia, Canada, Cuba, Indonesia, South Korea, Malaysia, New Zealand, the Philippines, Singapore, South Africa	Granted	2026 to 2028	Composition of matter
	Mucosal Immunogenic substances comprising a polyinosinic acid- polycytidylic acid-based adjuvant	Beijing Yisheng	China	Granted	2026	
		Singapore Yisheng	Taiwan (China)	Granted	2027	
		Singapore Yisheng	The European Union, Switzerland, France, United Kingdom, Germany, Singapore, the United States	Granted	2030	Process/Method
	Method for reducing DNA impurities in viral compositions	Beijing Yisheng	China	Granted	2030	
		Singapore Yisheng	Indonesia, the United States, the United States (continuation)	Granted	2038	Composition of matter
	PIKA HBV	A composition for treating and/or preventing Hepatitis B virus infection	Singapore Yisheng	Indonesia, the United States, the United States (continuation)	Granted	2038

[Table of Contents](#)

Product/technology	Patent name	Owner/applicant	Jurisdiction	Patent status ⁽¹⁾	Patent expiration	Type of patent
		Singapore Yisheng	Australia, Canada, Brazil, Hong Kong, Cuba, the European Union, India, South Korea, Mexico, Malaysia, New Zealand, the Philippines, Russia, Singapore, Thailand, Vietnam, China, South Africa	Pending	N/A	
PIKA rabies vaccine (Vero cell)	A composition comprising PIKA adjuvant	Singapore Yisheng	China, Indonesia, India, Russia, the Philippines, South Africa	Granted	2034 to 2037	Composition of matter
		Singapore Yisheng	Brazil, Thailand, the United States, Vietnam	Pending	N/A	
PIKA YS-ON-001 (Cancer)	A composition comprising PIC for treatment of cancer	Singapore Yisheng	Australia, the United States, the European Union, Indonesia, India, South Korea, Mexico, Russia, Singapore, South Africa	Granted	2037 to 2038	Composition of matter
		Singapore Yisheng	China, Brazil, Canada, Hong Kong, Cuba, Malaysia, New Zealand, the Philippines, Thailand, the United States (continuation), Vietnam	Pending	N/A	
	Method for adapting influenza viruses to vero cell	Singapore Yisheng	the United States	Granted	2038	Method/Process
		Singapore Yisheng	Singapore, the United States (continuation), China, the European Union	Pending	N/A	
PIKA YS-ON-001	A cancer tumor treatment medication and its application in the preparation of medication for treating cancer tumor	Beijing Yisheng	China	Granted	2025	Composition
PIKA	Composition	Beijing	South Africa	Granted	2042	
COVID-19	containing polynucleotide and its application in preventing or treating COVID-19	Yisheng & Liaoning Yisheng	China, the United States, New Zealand, Singapore, the United Arab Emirates	Pending	N/A	

(1) Although YS Group filed certain patent applications outside China, some of them are still at the unpublished stage. YS Group has uniformly named the legal status of patent applications outside China that have not been granted, whether published or not, as “pending.”

Trademarks and domain names

As of the date of this prospectus, YS Group owned 24 registered trademarks in China. YS Group has three registered domain names, namely liaoningyisheng.com, yishengbio.com, and ysiopharm.com.

As its brand name is becoming more recognized in the vaccine market, YS Group is working to maintain, increase and enforce its rights in this trademark portfolio, the protection of which is important to YS Group's reputation and branding.

During the three fiscal years ended March 31, 2023 and six months ended September 30, 2023 and up to the date of this prospectus, YS Group has not been involved in any material proceedings in respect of intellectual property right infringement claims against YS Group or initiated by YS Group. However, there are risks that YS Group may be subject to claims that YS Group has infringed the intellectual property rights of third parties, and YS Group may not be able to adequately protect its own intellectual property rights. For details, see "Risk Factors — Risks Related to YS Group's Intellectual Property."

Manufacturing

Manufacturing facilities

YS Group has been independently manufacturing its clinical stage biologics. As of the date of this prospectus, YS Group manufactures YSJATM rabies vaccine in Shenyang, China through its own manufacturing facilities. YS Group has not contracted with third parties to manufacture its marketed product.

Manufacturing is subject to extensive regulations that impose various procedural and documentation requirements governing record keeping, manufacturing processes and controls, personnel, quality control and quality assurance, among others. YS Group's manufacturing facilities operate under GMP conditions, which are regulatory requirements for the production of pharmaceuticals that will be used in humans.

In November 2022, YS Group's manufacturing facilities for PIKA recombinant COVID-19 vaccine product passed an audit by a European Union Qualified Person (QP). The audit was based on the guidance of European Union Good Manufacturing Practice ("EU GMP") and the guiding principles of the International Council for Harmonisation of Technical Requirements for Pharmaceuticals for Human Use (ICH). This EU QP audit involved a comprehensive and in-depth audit focused on the production quality of PIKA recombinant COVID-19 vaccine. The audit covered production systems, facility and equipment management, quality control, quality assurance, material management and other systems. This indicates that the manufacturing site of YS Group complies with European pharmaceutical GMP standards and has the ability to provide high quality pharmaceutical product for clinical studies and commercialization in European and international markets.

YS Group's current manufacturing facilities, certified under China 2010 GMP standard, have an annual production capacity of approximately 15 million doses of YSJATM rabies vaccine. In the three fiscal years ended March 31, 2023 and the six months ended September 30, 2023, YS Group manufactured approximately 34.6 million doses of YSJATM rabies vaccine. Since the GMP certified plant started production in February 2020, the utilization has increased gradually and reached approximately 58.33%, 81.25%, 100% and 108% for the fiscal year ended March 31, 2021, 2022 and 2023 and the six months ended September 30, 2023 respectively. The utilization rate is calculated by dividing the raw material input of a given three-month period by the corresponding production capacity during the same period.

YS Group has adopted a series of advanced measures and technologies for the current manufacturing facilities to improve YS Group's quality control. See "— Quality Management" for details. YS Group has also implemented new engineering specifications and equipment and machinery for its manufacturing processes. For example, YS Group developed in-house and implemented sterilization technology and devices in the heating, ventilation, air-conditioning and cooling systems used in its manufacturing procedures to ensure product quality and purity for human use. YS Group

[Table of Contents](#)

leveled up its manufacturing techniques to elevate the product standard of its vaccines, such as enhancing the method to remove residual DNA and protein impurities in vaccines. YS Group also installed the continuous mixing solution tank system and pipeline network to transport fluids throughout the plants, which reduces the chances of contamination and pollution. In addition, YS Group installed the circulating steam system to provide enduring, system-wide sterilization.

Furthermore, to avoid human error and contamination risk, YS Group installed a fully automated transportation vehicle system for sample handling and delivery in its filling and packaging workshop.

YS Group has equipped its current manufacturing facilities with engineering specification to produce YSJA™ rabies vaccine, which is different from the engineering specification for PIKA-related products. If the demand for YSJA™ rabies vaccine were to decrease, YS Group would modify its current manufacturing facilities accordingly and upgrade the engineering specification with bioreactor specification to produce PIKA-related products. Based on YS Group's manufacturing experience, YS Group believes the relevant modification process is practicable and manageable and can be completed in a timely manner.

Expansion plan

YS Group owns the land use right to three adjacent parcels of land located in Shenyang Economy and Technology Development Zone, Shenyang, China with an aggregate site area of 215,357 sq.m. To facilitate the R&D efforts and the potential product launches, YS Group plans to establish new manufacturing workshops in China to meet additional commercial demand of new product launches. The following table sets forth certain details of YS Group's expansion plan as of the date of this prospectus.

Project	Construction area	Actual/expected construction commencement date	Expected construction completion date	Expected manufacturing capacity
	(sq.m.)			(in total number of doses/year)
Two manufacturing workshops for PIKA recombinant COVID-19 vaccine in Shenyang (China)	6,831	March 2021	In 2024	500 million

YS Group may face a number of uncertainties in implementing its expansion plan, including its ability to obtain the requisite filings, permits, licenses and approvals for the construction and operation of the new facilities, the risk of construction delays and delays in equipment procurement, and its ability to timely recruit sufficient qualified staff. Furthermore, if YS Group fails to receive the NDA approvals of its product candidates or conduct product launches in a time manner, or at all, YS Group may have the additional manufacturing capacity underutilized, which could adversely impact YS Group's prospects, business and liquidity.

Manufacturing Process

The following diagram summarizes the major steps of the manufacturing process of YSJA™ rabies vaccine.

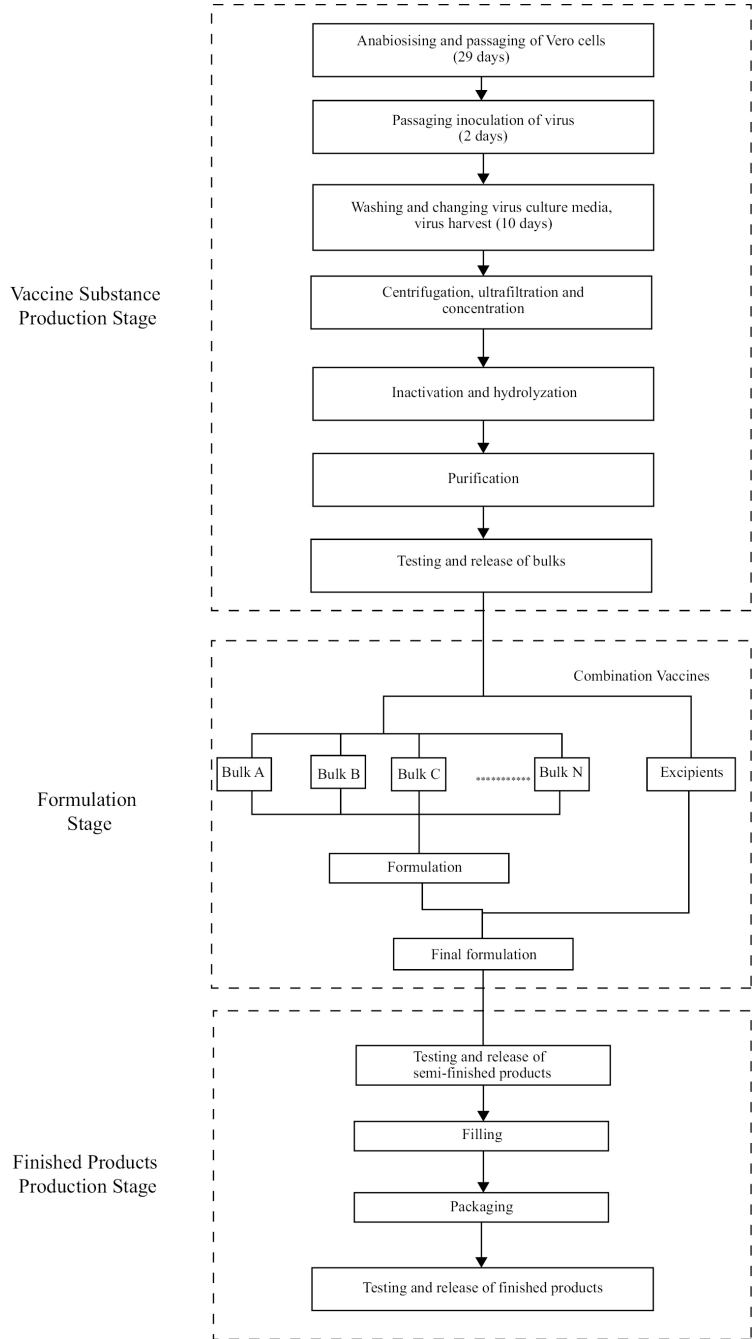

[Table of Contents](#)

The following is a brief description of the key steps in YS Group's manufacturing process.

- *Anabiosising and passaging of Vero cells.* Vero cells used for production are taken out from the working cell bank and restored to normal state through temperature change to meet the needs of culturing. The anabiosised cells are cultured in specific bottles with culture media. After several generations, the cells can be used for subsequent virus infection.
- *Passaging and inoculation of virus, washing and changing virus culture media, virus harvest* The virus will reproduce after being inoculated to the cultured Vero cells, and then be used in the later production process. The virus is also key ingredients of vaccine, which can be used as antigen to activate immune system to produce immune response.
- *Centrifugation, ultrafiltration and concentration.* The virus is separated from the debris of the host cells through the centrifugation process, and the harvested virus solution undergoes ultrafiltration to reach effective antigen concentration.
- *Inactivation and hydrolyzation of virus.* The nucleic acid structure of the virus is destroyed through the action of the inactivating agent 3-propiolactone, after which the virus loses its ability to infect. However, the protein structure is preserved and immunogenicity is retained. In addition, the inactivator is degraded to compounds through hydrolyzation so that it will not affect human body.
- *Purification.* Through gel chromatography antigen, pure virus antigen is obtained by removing impurities such as impure protein, host DNA, residual serum and antibiotics produced during the process of pre-production.
- *Formulation and preparation of semi-finished products.* The purified virus is mixed with stabilizers and excipients for subsequent filling.
- *Filling and lyophilization.* The semi-finished products are transported to the filling equipment through the pipeline system for automatic filling. After filling, the products are transferred to the freeze-drying machine through the automatic feeding and discharging system for freeze-drying, so as to change the products from liquid state to solid state.
- *Packaging.* The freeze-dried products were capped, lamp inspected and labeled, and then packaged in different specifications in terms of vials and boxes.

The production period of YSJA™ rabies vaccine is approximately five months, and the shelf life of YSJA™ rabies vaccine is approximately 36 months.

Manufacturing machinery and equipment

YS Group's manufacturing facilities in Shenyang are equipped with machinery and equipment owned by it, including reactors, purifiers, automated media preparation station and lines, freeze-dryer, filling lines, probs and monitoring system, quality inspection and other equipment for different stages of YS Group's manufacturing process. YS Group adopted three-, five- and ten-year depreciation lines for its electronic equipment, transportation and mechanical equipment, respectively. As of the date of this prospectus, based on YS Group's regular inspection and maintenance of its equipment, its machines and equipment are in good working condition. YS Group did not experience any material or prolonged interruptions to its manufacturing process due to machinery or equipment failure in the three fiscal years ended March 31, 2023, the six months ended September 30, 2023 and up to the date of this prospectus. YS Group updates its manufacturing machinery and equipment based on its evaluation of the effectiveness of its performance.

INVENTORY MANAGEMENT

YS Group's inventory primarily consists of raw materials, packaging materials, testing reagents, instruments, finished goods, and consumables used for its vaccine development. YS Group procures raw materials and packing materials according to the estimated production time of its products, and as the case may be, generally maintain an inventory level of three to six months for raw materials to meet YS Group's vaccine production needs, and as the case may be, generally maintain an inventory level of one to two months for its packaging materials. For imported raw materials, YS Group as the case may be, generally maintains an inventory level of six to 12 months. YS Group maintains the

inventory level of four to six months of finished products according to the batch issuing cycle of biological products and the estimated customer demand. In particular, YS Group will closely monitor the vaccine bidding information of each province and the status of its applications to better plan its production and control its inventory level.

YS Group has established an inventory management system to monitor each stage of the warehousing process according to the GMP regulations. YS Group's inventory management system records inventory data, such as inventory balance and validity period, and keeps track of inventory levels, enabling YS Group to make adjustments whenever necessary. As part of GMP-compliant facilities, YS Group has a warehouse at its manufacturing facilities, including the inspection waiting areas and post inspection areas. Warehouse personnel are required to complete periodic training and are responsible for the inspection, storage and distribution of inventories. All inventory is separately stored in different areas of the warehouse according to the storage condition requirement, usage and batch number. In order to improve YS Group's logistics efficiency of its finished vaccine products, in addition to YS Group's centralized warehouse for finished vaccine products in its manufacturing site in Shenyang, YS Group has set up 26 satellite transition warehouses located at different regions across China as of September 30, 2023.

Quality Management

YS Group has established a comprehensive GMP-compliant quality management system to manage the day-to-day operations at its facilities, with a major emphasis on manufacturing management and finished vaccine product management. YS Group's quality management team is divided into quality assurance and quality control teams. YS Group's quality assurance team is responsible for establishing comprehensive quality policies, ensuring its compliance with global quality guidelines and maintaining all quality-related documentation, as well as validation function. YS Group's quality control team is responsible for quality testing, inspection and review for all its products and raw materials. In addition, YS Group has assembled a validation team for quality inspection and validation in respect of its machinery, facilities and manufacturing processes.

YS Group's comprehensive quality management system is supported by various stringent policies relating to vaccine research, development and manufacturing. For instance, YS Group designed and implemented a series of technical and procedural guidelines relating to the manufacturing of YSJA™ rabies vaccine, such as cell and strain preparation, formulation and packaging. YS Group also adopted multiple policies on the management of its laboratories, experiment data and samples. Moreover, YS Group's quality management system is designed to ensure compliance with the GMP, pharmacopoeia, labeling requirements and other applicable laws and regulations. Quality issues identified are documented, escalated to and reviewed by senior management. YS Group also conducts a formal risk assessment and justification process in accordance with the standards and procedures under its quality management system and policies.

YS Group has enhanced its manufacturing technologies and system with the procurement and upgrades of machinery and equipment, such as the sterile isolator, microplate reader, total organic carbon analyzer and chromatography equipment, and have validated their functionality and ability to generate accurate and effective data. YS Group also established various protocols to analyze and evaluate the standard of its manufacturing and packaging processes.

YS Group has established reliable testing procedures for raw materials, work-in-progress products, and finished products, which include (1) multiple procedures for raw and auxiliary materials, such as Earle's balanced salt solution microbial limits test, sterility test for human albumin solution, and moisture determination test; (2) multiple procedures for work-in-progress products, such as virus titration of single-harvest virus fluids, protein content determination test, and stock solution sterility test for freeze-dried, Vero cell human rabies vaccines; and (3) multiple procedures for finished products, such as protein residue test for Vero cells, residue determination of gentamicin sulfate, and abnormal toxicity test.

From time to time, YS Group adjusts its internal protocols, such as those on manufacturing processes and procedures, testing methods, sterile approaches and operating guidelines, to ensure they meet the requirement of the relevant laws and regulations in a timely manner. For instance, YS Group conducted a comprehensive review of its internal protocols in response to the amended appendix of biological products of the Guidelines on Good Manufacturing Practices (the "2020 Amendments"), pursuant to which YS Group made specific amendments or supplementation to more than 200 internal policies. The amendments cover a wide range of YS Group's manufacturing and R&D activities, including the testing methods of certain substances, the management and verification guidelines and quality standards relating to certain ingredients, work-in-progress products and culture media, and the operating guidelines involved in multiple quality examination procedures. In addition, YS Group reviewed the profiles and job responsibilities of

the relevant quality management personnel to ensure they have the expertise and qualifications required under the 2020 Amendments. YS Group is also in the process of constructing its manufacturing execution system (“MES”) and laboratory information management system (“LIMS”) to promote real-time information collection and enhance the reliability of the data generated or used in its manufacturing and R&D process. The implementation of MES will allow YS Group to establish a reliable platform that digitizes the manufacturing process and integrates multiple management modules, including such for production data management and quality management. The implementation of LIMS, which comprises both computer hardware and software, will allow YS Group to systematically collect, analyze, report and manage their information in the laboratory. YS Group launched the construction of MES and LIMS in February and April 2021, respectively. YS Group officially integrated MES into its manufacturing process for YSJA™ rabies vaccine and to officially adopt LIMS. The aggregate implementation fees for MES and LIMS incurred is approximately RMB7.4 million.

In terms of sterility testing, YS Group has adopted the soft-chamber isolators, which effectively guarantee the quality of the testing environment. YS Group requires all of its inspection staff to have relevant qualifications and receive systematic training on sterility inspection. They are also required to attend regular training on sterility inspection methods organized by the Liaoning Provincial Inspection, Testing and Certification Center and the National Institute for Food and Drug Control.

YS Group requires all employees to attend employment training as a prerequisite for employment. The training includes subjects on the GMP standards, primary laws and regulations relating to vaccines and drugs in China, microbiology, biosafety, job responsibilities, operational protocols and managerial procedures. Employees must pass YS Group’s assessments and obtain the requisite certificate before onboarding. Specifically, YS Group’s key personnel are required to pass a practice-based test on the respective inspection procedures before they assume their responsibilities.

Sales and Marketing

Sales model

YS Group operates primarily in the Category II vaccines market in China. Pursuant to the PRC laws and regulations, YS Group must win bids in the public tender process of the province-level CDCs, which give YS Group qualification to access the respective province-level markets. As of September 30, 2023, YS Group obtained qualifications at 30 out of 34 province-level CDCs in China. YS Group is then generally required to make direct sales to, and settle payment with, county-level CDCs, which may then distribute to healthcare providers. YS Group is independent from both province-level and county-level CDCs. In addition, YS Group is responsible for the quality control during transportation until the products are delivered to the county-level CDCs. The entire transportation of vaccines must be in a cold-chain, in which the temperature is usually required to range between 2°C and 8°C.

YS Group usually enters into sales agreements with county-level CDCs from time to time based on their purchase orders, instead of long-term agreements. Pursuant to the sales agreements, YS Group is required to deliver products to county-level CDCs, and they generally have seven days after delivery to dispute any quality issues. The purchase price is determined in the public tender process according to the provisions in the public tender agreements. YS Group typically requires payment by wire transfer and allow a credit period of three to four months, consistent with industry practice. YS Group typically does not allow return or exchange of vaccines sold or refund unless its products are defective or are substandard or are damaged during transportation.

As of September 30, 2023, YS Group had a dedicated in-house commercialization team of approximately 71 employees, with an average industry experience of over 13 years such as the sales and marketing of biologics at multinational corporations. YS Group’s commercialization team mainly monitors its sales performance and seeks growth opportunities by ensuring its sales relationships with CDCs in their covered regions. They manage and supervise YS Group’s service providers, conduct market research and analysis, and monitor information about product safety and quality. The remuneration of YS Group’s commercialization team comprises base salary and performance-based bonuses, which are determined based on a comprehensive matrix of factors such as the number, responsiveness, process management and planning, compliance status and information collection ability of the external service providers engaged by the commercialization team members.

In addition, YS Group expects to expand the commercial potential of YSJA™ rabies vaccine into certain Southeast Asian countries, such as Singapore, the Philippines, Vietnam and Malaysia. YS Group intends to seek potential partnership and licensing in those countries to facilitate its commercialization process. YS Group plans to assemble a sales force

[Table of Contents](#)

in collaboration with its local business partners, which will comprise both YS Group's internal sales management team and local salespersons with extensive resources and know-hows. YS Group also intends to accelerate its business growth overseas by obtaining additional valuable resources through strategic global collaborations and acquisitions. YS Group currently expects to manufacture its YSJA™ rabies vaccine through its Shenyang manufacturing facility in compliance with local laws and regulations, including local GMP requirements.

Marketing service providers

In line with industry practice, YS Group engages external service providers to support its sales and marketing efforts among practitioners and execute its sales plan. The extensive network of service providers assists in collecting and providing clinical information of products, including the product quality, safety and adverse event data from the clinical sites, monitoring the shipment and inventory at customer warehouse, managing account payable and payment collection, conducting product training and education programs for practitioner, which greatly strengthens its product presence and loyalty in the marketplace. As of September 30, 2023, YS Group engaged 136 service providers located at different regions to promote its products in China.

YS Group determines the service items required based on its business needs. YS Group then determines the price for each service item in light of market condition of similar services, and the frequencies and amount of services required in light of the demand of its products. YS Group recognizes service fee expenses based on the actual amount of services incurred. The service fees are determined through arm's length negotiations and based on the fair market price.

Public tender

YS Group is required to participate in the public tender process held by province-level CDCs in China and win the bid to make sales into the relevant provinces. In the public tender, bidders are typically required to provide their qualifications, proposed pricing, comparison with actual price in other regions, proposed major business terms, after-sale service plan, their financial credentials and introduction of products. A successful bid typically leads to a one- or two-year qualification to sell products within the relevant provinces. During such qualified period, vaccines must be sold at the bid price accepted during the tender in the relevant region. County-level CDCs can purchase vaccines from any successful bidder.

Pricing

YS Group determines the prices of its marketed product based on a number of factors, including competitive market position, market demands, cost of productions, product quality, affordability, price quotation of competing products in the bidding process, and the specific requirements from province-level CDCs as part of the bidding process. YS Group will also price the product candidates after obtaining NDA approvals in the future, the market price of which will be influenced by a number of factors, such as its costs of production, price quotations of competing products in the bidding process, its technological advantages, product quality and market trends, as well as changes in the levels of supply and demand. In addition, certain province-level CDCs may provide administrative guidance on pricing issues to relevant county-level CDCs under their administrative power, and such guidance may be determined on a stand-alone province level and/or on a case-by-case basis.

Transportation and storage

YS Group implements cold-chain transportation and storage in the entire delivery process to the county-level CDCs to ensure real time monitoring and control of temperature, and as well as tracking system to keep records of the temperature of vaccines during transportation and storage. As a result, YS Group has adopted cold chain logistics for product delivery primarily by engaging logistic companies with professional capabilities to make transportation of pharmaceuticals to deliver products via ground transportation, during which the temperature of the storage space of YS Group's products must be controlled and maintained in accordance with the relevant requirements. In addition, YS Group engaged 26 satellite transition warehouses located in different regions across China as of September 30, 2023 to deliver its vaccines to county-level CDCs.

Customers

YS Group started the sales of YSJA™ rabies vaccine and began to recognize the related revenues from October 2020, pursuant to which YS Group's customers are county-level CDCs. As required by government regulations and in line with industry practice, YS Group participates in the public tender process of the province-level CDCs, and if YS Group is successful in its bidding, the relevant province-level CDC will generally provide a public notice, pursuant to which YS Group enters into sales agreements and settle payments directly with county-level CDCs, which then distribute to healthcare providers. See “— Sales and Marketing — Sales Model.”

Raw Materials and Suppliers

The principal raw materials required for the production of YS Group's biologics involves animal-based cells, plasma albumin, calf serum and Medium 199 powder. YS Group obtains materials largely from suppliers in China, and maintain at least two suppliers for all but one of the raw materials it uses. YS Group has historically not experienced any shortages in the raw materials YS Group uses, and the prices have generally remained stable. However, a risk exists that an interruption in supplies would materially harm YS Group's business. YS Group typically orders raw materials and services on a purchase order basis and do not enter into long-term dedicated capacity or minimum supply arrangements. YS Group typically maintains inventory of raw materials sufficient for three months of production. In addition, YS Group performs periodical reviews of its suppliers and facilities in accordance with GMP requirements.

Purchases from YS Group's top five suppliers accounted for 59.6%, 44.7%, 66.9% and 56.1% of its total purchases in the fiscal year ended March 31, 2021, 2022 and 2023 and the six months ended September 30, 2023, respectively, and purchases from YS Group's largest supplier accounted for 37.9%, 20.9%, 37.9% and 28.8% of its total purchases in the same periods, respectively.

CROs

Consistent with industry practice, YS Group engaged certain independent CROs to conduct (1) preclinical efficacy tests, safety evaluation, compatibility studies on packing materials, and tests such as antigen component or structure tests and other chemical and biological tests; and (2) certain clinical trial design and implementation services. YS Group selected CROs based on various factors, including their reputation, research experience, quality and equipment and machinery in the vaccine and pharmaceutical fields. In particular, YS Group has engaged CROs in the R&D of PIKA rabies vaccine, PIKA Recombinant COVID-19 vaccine, YS-HBV-002 and YS-ON-002.

Generally, YS Group entered into separate agreements with CROs for each preclinical and services and executed statements of work for each preclinical or clinical trial services. Key terms of such service agreements with CROs are summarized as follows:

- *Services.* With respect to preclinical studies, the CROs mainly provide services, including but not limited to: (1) efficacy and safety evaluation, such as acute toxicity test in mice and long-term toxicity test in animals; (2) compatibility studies on YS Group's products and their packaging; (3) tests such as antigen component quality or structure tests and other chemical and biological tests. With respect to clinical trials, the CROs provide clinical monitoring and inspection services, clinical research coordinator services, data management services, medical monitoring services, and biological samples management to YS Group.
- *Term.* The term of agreements for preclinical studies mainly ranges from one to three years. The term of agreements for clinical trials generally expires after the completion of clinical trials. The CROs are generally required to complete the relevant preclinical and clinical services within the prescribed time limit.
- *Payments.* YS Group is required to make payments to the CROs according to milestones of services and payment terms as defined in the relevant service agreements. Payments are either on lump-sum basis or in installments according to milestones of the respective services.
- *Confidentiality.* The CROs shall not disclose or disseminate any confidential information without YS Group's consent, such as material, data and information provided by YS Group for the contracted services.

[Table of Contents](#)

- *Dispute resolution.* In the event of any disputes related to the enforcement of any agreement, the parties shall negotiate amicably. If an agreement cannot be reached, the parties have the right to sue.
- *Intellectual property rights.* Substantially all intellectual property rights arising from the preclinical studies and clinical trials conducted by CROs will be owned by YS Group. In certain cases and as prescribed under the relevant agreements, such as when YS Group develops new technological results with the technological service results provided by certain CROs during the contractual term, the intellectual property rights may belong to both parties.

Competition

YS Group's industry is highly competitive and subject to rapid and significant change. While YS Group believes that its management's research, development and commercialization experience provide YS Group with competitive advantages, YS Group faces competition from biopharmaceutical companies (including specialty pharmaceutical companies), generic drug companies, biologics drug companies, academic institutions, government agencies and research institutions.

For YSJA™ rabies, vaccine which is currently marketed in China, YS Group primarily faces competition from China-based pharmaceutical companies. For YS Group's product candidates, YS Group expects to face competition from a broad range of global and local pharmaceutical companies. Many of YS Group's competitors have significantly greater financial, technical and human resources than YS Group has, and mergers and acquisitions in the biopharmaceutical industry may result in even more resources being concentrated among a smaller number of YS Group's competitors. YS Group's commercial opportunity could be reduced or eliminated if YS Group's competitors develop or market products or other novel immunological biologics or vaccines that are more effective, safer or less costly than its current or future product candidates, or obtain regulatory approval for its products more rapidly than YS Group may obtain approval for its product candidates.

Licenses, Permits and Approvals

As of the date of this prospectus, YS Group has obtained material licenses, permissions or approvals for its current business operations in China and none of such license, permission or approvals current in effect have been withdrawn or revoked by the competent governmental authorities.

The following table sets out a list of material licenses, permits, and approvals currently held by YS Group.

Product	License/Permit	License/Permit Holder	Authority	Validity Period
YSJA™ rabies vaccine	Drug Re-registration Certificate	Liaoning Yisheng	Medical Products Administration of Liaoning Province	July 13, 2020 – July 12, 2025
YSJA™ rabies vaccine/PIKA Recombinant COVID-19 vaccine	Drug Manufacturing License	Liaoning Yisheng	Medical Products Administration of Liaoning Province	September 19, 2023 – August 14, 2024

Employees

As of September 30, 2023, YS Group had 754 full-time employees. The following table sets forth the number of YS Group's full-time employees by function as of September 30, 2023.

Function	As of September 30, 2023	
	Number of Employees	% of Total
Research and development	181	24%
General and administrative	242	32.1%
Manufacturing	260	34.48%
Sales, marketing and patient services	71	9.42%
Total	754	100%

[Table of Contents](#)

As required under labor laws in different jurisdictions, YS Group enters into individual employment contracts with its employees covering matters such as wages, bonuses, employee benefits, workplace safety, confidentiality obligations, non-competition and grounds for termination. In compliance with PRC regulations, YS Group participates in various employee social security plans that are organized by applicable governments, including housing, pension, medical insurance, work-related injury and unemployment benefit plans. YS Group is required under PRC laws to make contributions to employee benefit plans at specified percentages of the salaries.

YS Group's success depends on its ability to attract, retain and motivate qualified personnel. As part of its retention strategy, YS Group offers employees competitive salaries, performance-based cash bonuses, share-based compensation and other incentives. In order to maintain a competitive edge, YS Group will continue to focus on attracting and retaining qualified professionals by providing an incentive-based and market-driven compensation structure that rewards performance and results. In addition to on-the-job training, YS Group regularly provides management, technology, regulatory and other training to its employees through internally developed training programs or professional consultants.

YS Group believes that it generally maintains a positive working relationship with its current employees. During the three fiscal years ended March 31, 2023, the six months ended September 30, 2023, and up to the date of this prospectus, YS Group has not encountered labor disputes that would have a substantial and detrimental impact on its business operations.

Properties, Plants and Equipment

Owned properties

As of September 30, 2023, YS Group owned and operated one business facility in Shenyang, China primarily for manufacturing purposes. YS Group has built two manufacturing workshops for YSJA™ rabies vaccine, which are located in the Shenyang Economy and Technology Development Zone, Shenyang, China. YS Group has purchased the land use right to this area, which consists of land use rights to three pieces of land adjacent to each other, including (1) a right of land use for 44,655 sq.m, which will expire in January 2060, (2) a right of land use for 73,724 sq.m, which will expire in January 2060, and (3) a right of land use for 96,978 sq.m, which will expire in December 2056.

Leased properties

As of September 30, 2023, YS Group operated its business through five leased properties in Beijing, the United States, Singapore and Philippines. Such properties primarily serve as offices. The expiration dates of two leased properties in Beijing, the leased properties in United, the leased properties in Singapore and Philippines are November 2023, September 2025, November 2025, March 2025 and April 2026, respectively. YS Group plans to renew its leases or negotiate new terms when the existing leases expire.

As of September 30, 2023, YS Group had leased property in Beijing with a total gross floor area of 5,047 sq.m., which was subject to a mortgage that had been placed before YS Group entered into the relevant lease agreement. YS Group faced the risks that it may not be able to continue to use the leased property upon foreclosure.

Insurance

YS Group has maintained liability insurance in China and Singapore in compliance with relevant local regulations to cover liability claims that may arise from incidents relating to the clinical trials of its product candidates. YS Group maintains compulsory liability insurance for YSJA™ rabies vaccine in China. YS Group's existing insurance coverage may not be sufficient to cover any claim for product liability or damage to its fixed assets. YS Group does not maintain any business interruption insurance.

Legal Proceedings and Compliance

YS Group is subject to legal proceedings, investigations and claims arising in the ordinary course of its business from time to time, including, among others, actions with respect to product liability and labor disputes. In the three fiscal years ended March 31, 2023 and up to the date of this prospectus, YS Group has not been involved in any litigation or arbitration proceedings pending that could have a material and adverse effect on its business, financial condition or results of operations.

Environmental Protection, Occupational Health and Safety, and Social Responsibility

YS Group is subject to environmental protection and occupational health and safety laws and regulations in China. As of the date of this prospectus, YS Group has not had any incidents or complaints that would materially and adversely affect its business, financial condition or results of operations. YS Group strives to operate its manufacturing facilities in a manner that protects the environment and the health and safety of its employees and communities. YS Group implemented company-wide environmental, health and safety (“EHS”) policies and operating procedures relating to waste treatment, process safety management, workplace health and safety requirements, and emergency planning and response. For instance, for the waste treatment, YS Group incorporated the waste management and minimization requirement to establish the characterization and management of wastes or by-products which are either disposed or recycled. For the process safety management, YS Group has established minimum requirements related to machine safety, trial process safety and personal protection. YS Group also designated responsible personnel to ensure employees’ awareness and compliance with the EHS policy. With respect to its manufacturing process and facilities, YS Group implemented a series of measures to reduce the potential pollution and waste associated with its manufacturing activities. For instance, the biologically active waste liquid discharged in YS Group’s production process is subject to a high-temperature inactivation process, through which it reaches the relevant discharge standard. In addition, YS Group engages qualified service providers to dispose solid waste generated in its manufacturing process in accordance with the medical waste regulations. YS Group also continuously upgrades its manufacturing techniques and raw materials and consumables to minimize the negative impact of its manufacturing activities on the environment.

YS Group entered into employment contracts with its employees in accordance with the applicable PRC laws and regulations. YS Group hires employees based on their merits, and it is YS Group’s corporate policy to offer equal opportunities to its employees regardless of gender, age, race, religion or any other social or personal characteristics. YS Group also strives to provide a safe working environment for its employees. YS Group implemented work safety guidelines setting out safety practices, accident prevention and accident reporting. In particular, YS Group has established and implemented guidelines in accordance with relevant PRC laws and regulations on the storage, management, handling and use of viruses and bacteria. These guidelines include those related to the recording and inspection of lots of viruses and bacteria, a multi-department approval process to obtain viruses and bacteria from YS Group’s inventory, as well as the safe disposal of viruses and bacteria. YS Group’s employees with specified responsibilities, including handling certain equipment and conducting animal research, are required to hold relevant qualifications, as well as wearing proper safety gear when working. YS Group conducts safety inspections of its manufacturing facilities regularly.

Regulations

Laws and Regulations in China

Laws and Regulations Relating to Drugs

Major regulatory authorities

YS Group conduct its business in PRC and it is now principally subject to the supervision of the National Medical Products Administration and its local counterparts. The National Medical Products Administration was established in accordance with the Institutional Reform Program of the State Council promulgated by the National People’s Congress (the “NPC”) in March 2018, and the predecessor of the National Medical Products Administration is the China Food and Drug Administration (the “CFDA,” together with the National Medical Products Administration, hereinafter collectively, the “NMPA”). The NMPA is the primary regulatory agency for pharmaceutical products and businesses and regulates almost all of the key stages of the life-cycle of pharmaceutical products, including nonclinical studies, clinical trials, marketing approvals, manufacturing, advertising and promotion, distribution, and pharmacovigilance (i.e., post-marketing safety reporting obligations), and it is under the supervision of State Administration for Market Regulation (the “SAMR”), a newly established institution for supervising and administrating the market in China.

The Center for Drug Evaluation (the “CDE”), which is a subsidiary of the NMPA, conducts the technical evaluation on each drug and biologic application to assess the safety and efficacy of each candidate. The National Health Commission of the PRC, formerly known by the names the Ministry of Health and National Health and Family.

[Table of Contents](#)

Planning Commission (hereinafter collectively, the “NHC”), is China’s primary healthcare regulatory agency. It is responsible for overseeing the operation of medical institutions, some of which also serve as clinical trial sites. NHC also plays a significant role in drug reimbursement.

The National Institutes for Food and Drug Control is a public institution directly subordinate to CFDA and the statutory authority and supreme technical arbitration institution for inspecting the quality of pharmaceuticals and biological products. It is responsible for the approval and registration inspection, import inspection, supervision and inspection, safety evaluation of drugs, biological products, medical devices, foods, dietary supplements, cosmetics, laboratory animals and package materials and the lot release of biological products, the research, distribution and management of the national drug and medical device reference materials and bacterial and viral strains for production verification, as well as the relevant technical research.

Chinese Center for Disease Control and Prevention is a public welfare institution established by the government to implement the national-level disease control and prevention and the public health technology management and services. Its main responsibility is to enhance the research on the disease control and prevention strategies and measures, participate in the vaccine research, carry out vaccine application result evaluation and immunity planning strategy research, and provide technical guidance and assessment on the implementation of the national immunity strategy under the leadership of NHC and the key tasks in national disease control and prevention.

Reform of medical and healthcare system

Pursuant to the Opinions of the State Council on Deepening the Reform of the Medical and Healthcare System issued on March 17, 2009, the reform of the medical and healthcare system has been orderly conducted. The medical insurance system has been gradually improved and the basic medical mechanism has been consolidated and improved.

On October 25, 2016, the State Council introduced the Plan for Healthy China 2030, which proposes to (1) improve the system for collaborative innovation involving different aspects of policy, industry, education, research and practice, and promoting medical innovation, transformation and upgrading, (2) research to establish an examination and approval system based on clinical effects, and raise the examination and approval standards for drugs (medical devices), and (3) accelerate the review and approval of innovative drugs (medical devices) and new drugs (medical devices) that are urgently needed in clinical practice.

According to the Notice of the Key Tasks of Deepening the Reform of Medical and Healthcare System in the second half of 2020, issued by the General Office of the State Council in July 2020, the government shall improve the public health emergency supplies guarantee system and increase investment in R&D of vaccines, drugs, and rapid testing technologies. Besides, the government shall gradually establish and improve the drug information traceability mechanism, and realize the “one product, one code” of the drugs which are applied to centralized procurement and use by national organizations and vaccines.

In July 2023, six authorities such as the National Health Commission, the National Healthcare Security Administration and the National Medical Products Administration, jointly issued the Key Work Tasks for Deepening the Reform of Pharmaceutical and Health System in the Second Half of 2023, confirming the key tasks and work arrangements for further deepening the medical reform, which proposes to carry out comprehensive clinical evaluation of medicines and improve the working mechanism for monitoring the use of medicines. Besides, the government shall carry out full-coverage inspections of vaccine manufacturers and random inspections of blood product manufacturers.

Drug research and development

Pursuant to the Drug Administration Law of the PRC (the “Drug Administration Law”), last amended on August 26, 2019 and became effective on December 1, 2019, the State encourages the R&D of new drugs, and protects the legal rights and interests of citizens, legal persons and other organizations in the R&D of new drugs. The dossier on a new drug R&D, including the manufacturing method, quality standards, results of pharmacological and toxicological tests and the related data, documents and the samples, shall, in accordance with the regulations of NMPA be submitted to the competent authority for approval before the clinical trial is conducted. The NMPA shall, within 60 business days from the date on which the application for such clinical trial is accepted, decide on whether to approve it and then notify the clinical trial applicant. In the case of failure to notify the applicant within the prescribed time limit, it shall be deemed as approved. When a new drug has gone through the clinical trial and passed the evaluation, a drug registration certificate shall be issued upon approval by NMPA.

[Table of Contents](#)

According to the Provisions for Drug Registration (the “Drug Registration Provisions”) which was last revised on January 22, 2020 and became effective on July 1, 2020, clinical trial of drugs shall be subject to approval, and bioequivalence test shall be filed; clinical trial of drugs shall comply with the Good Clinical Practice of Pharmaceutical Products (the “Good Clinical Practice”) and shall be carried out by drug clinical trial organizations which comply with the relevant provisions. Clinical trials of drugs shall consist of phases I, II, III and IV clinical trials as well as bioequivalence test. Based on the characteristics of drugs and research objective, the research contents shall include clinical pharmacology research, exploratory clinical trial, confirmatory clinical trial and post-marketing clinical research. On September 6, 2013, the Announcement of the NMPA on Drug Clinical Trial Information Platform providing that, instead of the aforementioned registration filed with the NMPA, all clinical trials approved by the NMPA and conducted in the PRC shall complete clinical trial registration and publish trial information through the Drug Clinical Trial Information Platform.

The Announcement on Adjusting Evaluation and Approval Procedures for Clinical Trials for Drugs was promulgated by the NMPA on July 24, 2018, according to which, if the applicant does not receive any negative or questioning opinions from the CDE within 60 days after the application is accepted and the fees are paid, the applicant can carry out the clinical trials in accordance with the submitted trial protocol.

The institutions for non-clinical safety evaluation and study and clinical trial organizations shall respectively implement the Good Laboratory Practice for Non-Clinical Laboratory Studies which became effective on September 1, 2017, and Good Clinical Practice for Clinical Laboratory Studies which was effective on September 1, 2003 and last revised on April 23, 2020 and became effective on July 1, 2020. If certain actions in the preclinical trial research and clinical research conducted for a clinical application trial, and/or in the application procedures for registration of medicines, are in violation of the relevant rules and regulations, the NMPA is authorized to handle such cases pursuant to the Measures regarding Non-compliance with Relevant Rules of Research and Application for Registration of Medicines (Trial) promulgated on and effective from September 1, 1999.

Regulations on human genetic resources

The Ministry of Science and Technology promulgated the Service Guide for Administrative Licensing Items concerning Examination and Approval of Sampling, Collecting, Trading or Exporting Human Genetic Resources, or Taking Such Resources out of the PRC in July 2015, according to which, the sampling, collection or research activities of human genetic resources by a foreign-invested sponsor fall within the scope of international cooperation, and the cooperating organization of China shall apply for approval of the China Human Genetic Resources Management Office through the online system. The Ministry of Science and Technology further promulgated the Circular on Optimizing the Administrative Examination and Approval of Human Genetic Resources in October 2017, which became effective in December 2017 and simplified the approval of sampling and collecting human genetic resources for the purpose of listing a drug in the PRC.

The Regulation on the Management of Human Genetic Resources, as promulgated by the State Council on May 28, 2019 and effective on July 1, 2019, further regulates the collection, preservation, usage and provision of human genetic resources. According to this regulation, “human genetic resource” includes human genetic resource materials and information. Human genetic resource materials refer to organs, tissues, cells and other genetic materials containing human genome, genes and other genetic materials. Human genetic resource information refers to information, such as data, generated by human genetic resources materials. The Administrative Department of Science and Technology under the State Council is responsible for the management of human genetic resources at the national level, and the administrative departments of science and technology under the provincial governments are responsible for the management of human genetic resources at local level. Foreign organizations, individuals and institutions established or actually controlled by foreign organizations and individuals are not allowed to collect or preserve human genetic resources (including organs, tissues, cells and other genetic materials of the human genome and genes) in China or provide human genetic resources abroad.

Pursuant to the Implementation Measures of Administrative Regulations of the PRC on Human Genetic Resources promulgated by the Ministry of Science and Technology on May 26, 2023, which came into effect on July 1, 2023, institutions established or actually controlled by foreign organizations and individuals shall include the following circumstances: (1) the foreign organization or individual holds or indirectly holds 50% or more of the shares, equity, voting rights, property shares, or other similar rights and interests of an institution; (2) the foreign organization or individual holds or indirectly holds less than 50% of the shares, equity, voting rights, property shares, or other similar

rights and interests of the institution, but the voting rights or other rights and interests enjoyed by it or him/her are sufficient to dominate or exert a significant impact on the decision-making, management, and other acts of the institution; (3) the foreign organization or individual is able to dominate or exert a significant impact on the decision-making, management, and other acts of the institution through investment relations, agreements, or other arrangements; and (4) any other circumstance prescribed by laws, administrative regulations, and rules.

Laws and regulations on drug registration

According to the currently effective Drug Registration Provisions, if all the regulatory requirements are satisfied, the NMPA will grant a new drug certificate valid for five years and the applicant shall apply for renewal six months prior to its expiration date. According to the Drug Registration Provisions, drug registration is regulated according to Chinese medicine, chemical medicine and biological products. The Drug Registration Provisions provides detailed procedural and substantive requirements for the key regulatory concepts established by the Drug Administration Law, confirms a number of reform actions that have been taken in the past years, including (1) the full implementation of Marketing Authorization Holder System and implied approval of the commencement of clinical trial; (2) implementing associated review of drugs, excipients and packaging materials; and (3) introducing four procedures for expedited registration of drugs, which are procedures for ground-breaking therapeutic drugs, procedures for conditional approval, procedures for prioritized reviews and approval, and procedures for special examination and approval.

On December 21, 2017, the Opinions on Encouraging the Prioritized Evaluation and Approval for Drug Innovations was promulgated by the NMPA and further replaced by the Announcement on the Release of Three Documents including the Procedures for the Evaluation of Breakthrough Therapeutic Drugs (Trial) issued by the NMPA on July 7, 2020. The three documents include the Procedures for the Evaluation of Breakthrough Therapeutic Drugs (Trial), Procedures for the Evaluation and Approval of the Listing Application for Conditional Approval of Drugs (Trial) and Procedures for Prioritized Evaluation and Approval for Drug Marketing (Trial), which, among others, allow the applicant to apply for the breakthrough therapy drug procedure during the phase I and II clinical trials and normally no later than the commencement of phase III clinical trials for the innovative or improved drugs, which are used for the prevention and treatment of diseases that seriously endanger life or seriously affect quality of life and there is no effective means of prevention and treatment or there is sufficient evidence to show a significant clinical advantage over the existing treatments. In addition, when applying for the marketing license of a drug, for the drugs with obvious clinical value, the applicant can apply for the prior evaluation and approval procedure.

According to the Special Examination and Approval of Registration of New Drugs (the “Special Examination and Approval Provisions”) which was promulgated and implemented on January 7, 2009 by the NMPA, the NMPA conducts special examination and approval for new drug registration applications when (1) the effective constituent of drug is extracted from plants, animals and minerals and the preparations thereof have never been marketed in China, and the material medicines and the preparations thereof are newly discovered; (2) the chemical raw material medicines, as well as the preparations thereof and the biological product have not been approved for marketing in China and abroad; (3) the new drugs are for treating the Acquired Immune Deficiency Syndrome, malignant tumors and orphan diseases and have obvious advantages in clinic treatment; or (4) the new drugs are for treating diseases with no effective methods of treatment. The Special Examination and Approval Provisions further provides that the applicant may file for special examination and approval at the clinical trial application stage if the drug candidate falls within items (1) or (2), and if the drug candidates fall within items (3) or (4), the application for special examination and approval cannot be made until filing for production.

Laws and regulations on drug manufacturing

Pursuant to the Drug Administration Law and the Implementing Regulations of the Drug Administration Law of the PRC (the “Drug Administration Implementing Regulations”), a drug manufacturing enterprise is required to obtain a Drug Manufacturing License from the relevant provincial drug administration authority of the PRC. The grant of such permit is subject to an inspection of the manufacturing facilities, and an inspection to determine whether the sanitary condition, quality assurance systems, management structure and equipment meet the required standards. Pursuant to the Drug Administration Implementing Regulations and the Measures on the Supervision and Administration of the Manufacture of Drugs amended on November 17, 2017 and January 22, 2020 and effective on July 1, 2020 (the “Drug Manufacture Supervision Measures”), the drug manufacturing license is valid for five years and the drug manufacturing enterprises shall apply to the original authority that issued such license for renewal six months

[Table of Contents](#)

prior to its expiration date. Where the marketing authorization holder consents to the production of pharmaceutical preparations, the marketing authorization holder shall apply to the provincial department of the NMPA for a Drug Manufacturing License and subject it to the inspection and other administrative supervision by government agencies.

The Guidelines on Good Manufacturing Practices (the “Guidelines”) which were amended in 1998 and 2010, set the basic standards for the manufacture of pharmaceuticals. The 2010 amendments to the Guidelines were promulgated by the Ministry of Health (now known as the NHC) on January 17, 2011 and came into effect on March 1, 2011. The Guidelines comprise a set of detailed standard guidelines governing the manufacture of drugs, including quality management, organization and personnel, plant and facilities, equipment, materials and products, confirmation and verification, production management, quality control and quality assurance, commissioned production and commissioned inspection, product shipping and recall, and self-inspection. Besides, the major differences between the 2010 revised edition and the 1998 revised edition of the Guidelines include the following: (1) the 2010 revised edition has more emphasis on the aseptic condition and purification during the production process; for example, the exposed processing areas of some non-sterile products shall be designed according to requirements for sterile products; (2) the 2010 revised edition enhances requirements for the production equipment and facilities, which involve not only the design and layout of the production area, storage area, quality control area and auxiliary area, but also the design, installation, maintenance, use, cleaning, status marking and calibration of the equipment and facilities; (3) the 2010 revised edition enhances the standard of management for drug manufacturing enterprises, including but not limited to (i) enhancing the qualification requirements for key personnel, which should at least include the heads of the manufacturer, production management, quality management, and the qualified person; and (ii) requiring manufacturers to establish a quality assurance system with the support of a complete documentation system to ensure its effective operation; and (4) the 2010 revised edition requires proactive or retrospective adoption of quality risk management, which means a systematic process for the assessment, control, communication and review of quality risks, throughout the entire product life cycle.

The NMPA issued the amended appendix of biological products to the Guidelines on Good Manufacturing Practices (the “2020 Amendments”) in April 2020, which came into effect on July 1, 2020, except for the requirement on information system which came into effect in July 2022. The 2020 Amendments contain 63 articles in eight chapters, with six new added articles and 15 revised articles. The major changes under the 2020 Amendments include the following: (1) the 2020 Amendments require the manufacturers of biological products to establish and improve the biological safety management system in accordance with the laws and regulations related to biological safety management; (2) the 2020 Amendments further enhance the requirements for relevant practitioners, which include the requirements that (i) the training and examination of key personnel shall be strengthened and (ii) the authorized personnel designated to oversee and administer quality control shall hold a bachelor’s degree or above in pharmacy, medicine or other related specialties, and shall have more than five years’ experience in production quality management in related fields; (3) the 2020 Amendments add some detailed provisions concerning the production management and quality management, such as the requirements that (i) the suitability of culture media shall be examined, (ii) the acceptance criteria for chromatographic separation columns and methods for cleaning or sterilizing them shall be specified, and (iii) the adjuvants used for vaccines production shall be consistent with the relevant manufacturing process and quality standards approved by or filed with the drug administration authority; and (4) the 2020 Amendments also mandate that vaccine manufacturers shall truthfully record in electronic means all the data formed in the process of production and inspection to ensure that the whole production process is continuously compliant with the statutory requirements.

According to the Drug Administration Law, the requirement of obtaining a Good Manufacturing Practice Certificate is cancelled and the pharmaceutical manufacturing company shall comply with Good Manufacturing Practice for Drugs, establish and improve upon a drug manufacturing quality management system, ensure the whole drug manufacturing process continuously comply with statutory requirements.

Administration of affairs concerning laboratory animals

Pursuant to Regulations for Administration of Affairs Concerning Laboratory Animals approved by the State Council on October 31, 1988 and revised for the third time on March 1, 2017, the Administrative Measures on Good Practice of Laboratory Animals promulgated and implemented on December 11, 1997, and the Administrative Measures on the Certificate for Laboratory Animals (Trial) promulgated on December 5, 2001 and implemented on January 1, 2002, performing experimentation on animals requires a License for Use of Laboratory Animals.

Pharmaceutical directions and labels of pharmaceutical products

According to the Measures for the Administration of the Pharmaceutical Directions and Labels of Drugs effective on June 1, 2006, the pharmaceutical directions and labels of drugs should be reviewed and approved by the NMPA. A pharmaceutical direction should include the important scientific data concerning drug safety and efficacy in order to direct the safe and rational use of drugs. The inner label of a drug should bear such information as the drug's common name, indication or function, strength, dose and usage, production date, batch number, expiry date and drug manufacturer, and the outer label of a drug should indicate such information as the drug's name, ingredients, character, specifications, description of the drug's indications and contraindications, precautions, dosage, date of production, product batch number, valid term, approval number, manufacturing enterprise and any adverse reactions.

Advertisements of drugs

On April 29, 2021, the Standing Committee of the National People's Congress (the "SCNPC") revised the Advertising Law of the PRC, according to which certain contents shall not be included in advertisement of drugs, such as an assertion or guarantee on the efficacy or the safety, stating a cure rate or effective rate.

Pharmaceutical product export

According to the Approval by NMPA on Certain Issues of Pharmaceutical Products Export, promulgated and effective on September 20, 1999, whether the enterprise can obtain the right to operate import and export business and the qualification shall be approved by relevant foreign trade authority. The pharmaceutical products export shall mainly comply with the requirements of the importing country, so long as there is no special requirement by the importation country, the pharmaceutical supervisory and administrative departments support the export in principle based on the national policy of encouraging exports. However, under the Drug Administration Law, the export licenses issued by the relevant NMPA are required for the export of narcotics and psychotropic substances falling within the restricted scope prescribed by the State.

On November 9, 2018, the NMPA promulgated Regulations on the Administration of Certificates of Export Sales of Pharmaceuticals, according to which, where a drug manufacturer applies for a Drug Export Sales Certificate, it shall submit an application form for a drug export sales certificate to the local drug regulatory department at the provincial level. The term of validity of the Drug Export Sales Certificate shall not exceed two years, and shall not exceed the term of validity of all the certificates in the application materials, and a new application shall be made before the expiry of the period of validity.

Drug recalls

According to the Measures on Drug Recall effective from November 1, 2022, a drug manufacturer should establish and improve its recall system by collecting relevant information about drug safety and making an investigation and evaluation with respect to the drugs with potential safety hazards. If there are any potential safety hazards that endanger human health and life safety or any violation of statutory requirements in respect of any drugs sold in PRC, such manufacturer must start the drug recall procedures. Where a drug is recalled, the drug operating units and users should assist such manufacturer to satisfy its recall obligations by communicating the drug recall information and any feedback, controlling and recovering such drugs according to the recall plan.

Laws and regulations relating to vaccines

According to the Vaccine Administration Law of the PRC (the "VAL"), which was promulgated by the SCNPC on June 29, 2019 and came into effect on December 1, 2019, vaccines are divided into two categories based on whether it is under national immunization programs or not. For vaccines under national immunization programs, the competent health department of the State Council shall, in conjunction with the public finance department of the State Council, among others, organize centralized bidding or unified negotiation, and form and release bid price or transaction price, and vaccines shall be uniformly purchased by all provinces, autonomous regions and municipalities directly under the Central Government. Vaccines under other immunization programs other than vaccines under national immunization programs and vaccines not covered by immunization programs shall be purchased as organized by all provinces, autonomous regions and municipalities directly under the Central Government through provincial public resource trading platforms.

Vaccine administration

On January 15, 2017, the General Office of State Council issued Opinions on Further Enhancing Administration of Circulation and Vaccination of Vaccines, among others, to improve the work mechanism for the management of vaccines and promote the independent R&D and quality improvement of vaccines. The VAL requires the most stringent management system for vaccines, and at the same time, supports the basic research and applied research on vaccines, promotes the development and innovation of vaccines, including the development, production and reserve of vaccines for the prevention and control of serious diseases in the national strategy. Entities and individuals engaged in vaccine development, production, circulation and vaccination shall abide by the laws, regulations, rules, standards and specifications, ensure that the information during the whole process is true, accurate, complete and traceable, assume responsibilities in accordance with the law and accept social supervision.

Vaccine marketing authorization holders shall establish an electronic vaccine traceability system, which is connected with the national electronic vaccine traceability collaboration platform to realize the traceability and verifiability of the smallest packaging units of vaccines in the whole process of production, circulation and vaccination.

Development and registration of vaccines

On October 14, 2005, the NMPA promulgated the Notice on Issuing Six Technical Guidelines including the Technical Guidelines on Preclinical Study of Preventive Vaccines, which specified the requirements on preclinical research, change of production process, quality control in clinical stages of vaccine to ensure its safety and efficacy.

According to the VAL, clinical trials of vaccines shall be conducted or organized for implementation by Grade III medical institutions that meet the conditions prescribed by the drug administrative department under the State Council and the competent health department under the State Council, or by disease prevention and control institutions at or above the provincial level.

A vaccine to be marketed within the territory of China shall be approved by the drug administrative department under the State Council and obtain a drug registration certificate; when applying for registration of a vaccine, an applicant shall provide true, sufficient and reliable data, information and samples. With respect to the vaccines urgently needed for disease prevention and control as well as the innovative vaccines, the drug administrative department under the State Council shall prioritize their evaluation and approval.

Production and lot release of vaccines

Whoever engages in vaccine production activities shall, in addition to meeting the conditions for engaging in drug production activities as prescribed in the Drug Administration Law, also meet the following conditions: (1) having moderate scale and sufficient capacity reserves; (2) having systems, facilities and equipment for ensuring bio-safety; and (3) meeting the needs of disease prevention and control. A vaccine marketing authorization holder shall have the capacity for production of vaccines. If it is really necessary to entrust the production of vaccines in excess of its capacity, the vaccine marketing authorization holder shall obtain the approval of the drug administrative department under the State Council. Where it accepts the entrustment to produce vaccines, it shall abide by the provisions of this Law and the relevant provisions of the State, so as to guarantee the quality of vaccines.

The State adopts a lot release system for vaccines. Each batch of vaccines shall, before being sold or imported, be examined and inspected according to the relevant technical requirements by the lot release institution designated by the drug administrative department under the State Council. If the requirements are met, a lot release certificate shall be issued; otherwise, a notice on rejecting lot release shall be issued. According to the Measures for Administration of Lot Release of Biological Products (the "Lot Release Administration Measures") issued on December 13, 2002 and amended on February 1, 2018, the vaccine products with marketing approval shall be subject to document review, onsite verification and sample inspection by the designated drug control institution and pass the biological product lot release approval before the marketing and sales of each batch of products. On December 11, 2020, the SAMR amended the Measures for Administration of Lot Release of Biological Products, which came into effect on March 1, 2021 and does not make material changes on the substance of aforementioned provisions.

On July 8, 2022, the NMPA promulgated the Administrative Provisions on the Manufacture and Circulation of Vaccines, according to which, the marketing authorization holder shall assume the primary responsibilities for the safety, effectiveness and quality controllability of vaccines, carry out the management activities of post-marketing

[Table of Contents](#)

manufacture, circulation and other links of vaccines in accordance with laws and regulations and assume the corresponding responsibilities. An access system is implemented for the manufacture of vaccines and strictly controls the establishment of new vaccine manufacturers. A newly established vaccine manufacturer shall, in addition to meeting the conditions for the establishment of a vaccine manufacturer, conform to the relevant policies of the competent authority of the national vaccine industry. When applying for entrusted manufacture of vaccines, the entrusting party and the entrusted party shall, in accordance with the requirements of the relevant technical guiding principles, carry out research, evaluation and necessary verification, and the entrusting party shall, after completing the alteration of the corresponding production scope of the Drug Manufacturing License, file an application with the Center for Administrative Services and Complaints & Reports of the NMPA.

Circulation of vaccines

Based on the Drug Administration Law and the Law of the PRC on the Prevention and Treatment of Infectious Diseases, the State Council formulated and issued the Regulation on the Administration of Circulation and Vaccination of Vaccines on March 24, 2005 and revised this regulation on April 23, 2016. According to the Regulation on the Administration of Circulation and Vaccination of Vaccines, there are two types of vaccines. Category I vaccines refer to the vaccines provided by the government to citizens free of charge. Category II vaccines refer to other vaccines with which the citizens are voluntarily inoculated at their own expenses. Vaccine manufacturers shall supply Category I vaccines only to the provincial disease prevention and control institutions or other county-level designated disease prevention and control institutions according to the government purchase contract. The Category II vaccines shall be subject to collective purchase organized by provincial disease prevention and control institutions on the provincial public resource trading platform, and purchased by the disease prevention and control institutions and then distributed to local vaccination units. Besides, the vaccine manufacturers shall abide by the rules on the administration of vaccine storage and transport, and guarantee the quality of vaccines. Vaccines shall be stored and transported in the environment with the prescribed temperature during the entire process, shall not be isolated from the cold chain, and the temperature shall be monitored and recorded at regular time.

On June 29, 2019, the SCNPC promulgated the VAL, which involves, among others, the R&D, registration, production, lot release, circulation, vaccination, monitoring and handling of abnormal reactions of the vaccines, as well as the management after the marketing of vaccines.

On March 27, 2020, the Decision of the State Council to Amend and Repeal Certain Administrative Regulations (2020) (the "Decision") was issued and came into effect on the same day. According to the Decision, certain articles of seven administrative regulations were revised and ten administrative regulations, including the Administration of Circulation and Vaccination of Vaccines, were repealed. The repeal of the Administration of Circulation and Vaccination of Vaccines did not have a significant impact on YS Group production and business activities. Prior to the Decision, the VAL had in effect replaced the Administration of Circulation and Vaccination of Vaccines, since it covers certain key provisions, including the circulation and vaccination of vaccines, monitoring and handling of abnormal reactions, and relevant supporting measures.

According to the Opinions on Further Enhancing Vaccine Circulation and Vaccination Administration issued by the General Office of State Council on January 15, 2017, both the public vaccines and private vaccine should be procured online on the provincial public resource trading platform in accordance with the principles of transparency, competition, and fair trade.

According to the VAL, the competent health department under the State Council shall, in concert with the finance department under the State Council and other departments, organize centralized bidding or unified negotiation to form and publish the bid-winning price or transaction price of vaccines under the National Immunization Program, and all provinces, autonomous regions and municipalities directly under the Central Government shall implement centralized procurement. The procurement of vaccines under other immunization program and vaccines not under the immunization program other than those under the National Immunization Program shall be organized by provinces, autonomous regions and municipalities directly under the Central Government through provincial public resources trading platforms.

The price of vaccines shall be set reasonably and independently by the vaccine marketing authorization holder according to law. The price level, price difference rate and profit rate of vaccines shall be kept within a reasonable range.

[Table of Contents](#)

A vaccine marketing authorization holder shall, as agreed upon in the procurement contract, supply vaccines to the disease prevention and control institution. The disease prevention and control institutions shall supply vaccines to inoculation entities in accordance with the relevant provisions. Entities or individuals other than the disease prevention and control institutions shall not supply vaccines to inoculation entities, and inoculation entities shall not accept such vaccines. A vaccine marketing authorization holder shall, as agreed upon in the procurement contract, deliver vaccines to the disease prevention and control institution or the inoculation entity designated thereby. The vaccine marketing authorization holder and disease prevention and control institution that distribute vaccines themselves shall have the conditions for cold chain storage and transport of vaccines or may entrust eligible vaccine distribution entities to distribute vaccines. Vaccine marketing authorization holders shall establish an electronic vaccine traceability system, which is connected to the national electronic vaccine traceability collaboration platform to realize the traceability and verifiability of the smallest packaging units of vaccines in the whole process of production, circulation and vaccination. The disease prevention and control institutions shall truthfully record the information on vaccine circulation and vaccination in accordance with the relevant provisions, and shall provide the traceability information to the national electronic vaccine traceability collaboration platform in accordance with the relevant provisions.

A vaccine marketing authorization holder shall, when selling vaccines, provide a copy of the certificate of lot release or an electronic document affixed with its seal. If it sells imported vaccines, it shall also provide a copy of the imported drug clearance form or an electronic document affixed with its seal. A disease prevention and control institution or an inoculation entity shall, when receiving or purchasing vaccines, ask for the abovementioned supporting documents, and preserve them for inspection for at least five years after expiry of validity of the vaccines. A vaccine marketing authorization holder shall, in accordance with the provisions, set up true, accurate and complete sales records, and preserve them for inspection for at least five years after expiry of the validity of the vaccines.

According to the VAL, whoever engages in vaccine production activities shall, in addition to meeting the conditions for engaging in drug production activities as prescribed in the Drug Administration Law, meet the following conditions: (1) having moderate scale and sufficient capacity reserves; (2) having systems, facilities and equipment for ensuring bio-safety; and (3) meeting the needs of disease prevention and control. According to the Government Procurement Law of PRC, vaccine suppliers shall meet the following requirements as a supplier in government procurement: (1) having the capacity to assume civil liabilities independently; (2) having a good business reputation and sound financial and accounting systems; (3) having the equipment and professional expertise needed for performing contracts; (4) having a clean record of paying taxes and making financial contributions to social security funds in accordance with law; (5) having committed no major breaches of law in its business operation in the three years prior to its participation in the procurement; and (6) other requirements provided for in laws and administrative regulations. Other specific requirements may differ slightly from province to province, but generally speaking, vaccine suppliers should possess qualifications required for vaccine manufacturers, including but not limited to the Drug Manufacturing License and the drug registration approval.

Price Control of Vaccines

Pursuant to the VAL, vaccine price shall be determined by the vaccine marketing license holder in a legal, independent and rational manner. The price level, spread rate and profit rate of the vaccine shall be maintained at a reasonable level. The inoculation entity shall not charge any fees for the inoculation of vaccines under immunization programs. The inoculation entity that inoculates the vaccine not covered by immunization programs may, in addition to charging the vaccine fee, charge the vaccination service fee. The standards for charging vaccination service fees shall be determined by the competent price department of the people's government of the province, autonomous region or municipality directly under the Central Government in conjunction with the public finance department.

According to the Administrative Provisions on the Manufacture and Circulation of Vaccines, disease prevention and control institution, vaccination entity and the relevant parties of the entrusted storage and transportation enterprise shall, in accordance with the requirements of the national whole-process electronic traceability system for vaccines, faithfully record the information on the sale, storage, transportation and use of vaccines to realize the whole-process traceability of unit packages from production to use. The vaccine distributor shall, as required by the marketing authorization holder, truthfully and completely record the information on storage and transport.

Adverse Events

Pursuant to the VAL, if a lot release agency discovers any major quality risk of a vaccine during the lot release process, it shall promptly report to the drug supervision and administration department of the State Council and the drug supervision and administration departments of the People's Governments of different provinces, autonomous regions or municipalities directly under central government. The departments receiving the report should immediately conduct an on-site inspection of the marketing authorization holder of the vaccine and notify the lot release agency to not approve or suspend the lot release of the marketing authorization holder's related or all products based on the inspection results and order the rectification of the marketing authorization holder. In addition, for suspected abnormal reactions to vaccination, the disease prevention and control institutions shall report in a timely manner in accordance with related regulations, organize investigations and diagnoses, and inform the recipients or their guardians of the results of the investigations and diagnoses. If there is a dispute over the results of the investigation or diagnosis, an application for verification can be made in accordance with the verification method formulated by the health authorities under the State Council. In accordance with their respective responsibilities, the health authorities and drug supervision and administration departments of the People's Governments at or above the districted city level should organize the investigations and handling of any vaccination that causes death or severe disability of the recipient or any suspected abnormal group reactions to vaccination that have a major impact on the society.

Pursuant to the Lot Release Administration Measures, in any of the following situations, the lot release agencies should report to the drug supervision and administration departments of the provinces, autonomous regions or municipalities directly under central government where the lot release applicants and the production sites locate, suggest on-site inspections, and copy to the NMPA: (1) the sterility test is not qualified; (2) the effectiveness indexes such as efficacy are not qualified in two consecutive lots of inspection; (3) the material review indicates potential serious issues in quality control of the manufacturing, or the deviation in manufacturing techniques, quality difference, or failures and accidents in manufacturing need to be further investigated; (4) the application materials or samples for lot release may have authenticity problems; and (5) other situations that indicate major quality risks of the product. During the investigation and handling of the above-mentioned problems, the approval process or issuance of the corresponding varieties of the lot release applicant may be temporarily suspended. The drug supervision and administration departments of the provinces, autonomous regions, or municipalities directly under central government should conduct an on-site inspection within 10 days after receiving the notifications and recommendations from the lot release agencies. The drug supervision and administration departments of the provinces, autonomous regions, or municipalities directly under central government should provide a technical evaluation and a clear conclusion regarding the quality risks of to the lots of relevant products mentioned by the lot release agencies within 10 days after the inspection. Under extreme circumstances, the departments can appropriately extend the periods mentioned above with reasons provided.

Animal epidemic prevention

The Law of the PRC on Animal Epidemic Prevention (the "Animal Epidemic Prevention Law") issued by the Standing Committee of the NPC on July 3, 1997 and last amended on January 22, 2021, took effect on May 1, 2021. According to the Animal Epidemic Prevention Law, animal epidemics are classified into three categories based on their harm to the breeding industry and human health. Rabies falls under the Category II as it may do serious harm to human and animals and cause major financial losses and social impact. When an animal epidemic of Category II breaks out, the following control measures shall be taken: (1) the administrative department for agriculture and rural area under the local people's government at or above the county level shall demarcate the epidemic locations, epidemic areas and vulnerable areas; and (2) the local people's government at or above the county level shall, where necessary, organize the relevant departments and entities to take measures such as isolation, killing, destruction, disinfection, bio-safety treatment, emergency vaccination and restriction on the movement and circulation of the susceptible animals, animal products and related goods. Furthermore, under the Animal Epidemic Prevention Law, the entities and individuals that raise dogs shall have them administered with veterinary rabies vaccines regularly as required by relevant laws and regulations, and register at the local dog registration authority with an immunization certificate issued by an animal clinic.

Regulations relating to data privacy and anti-bribery

Data privacy

Pursuant to the Notice of the Supreme People's Court, the Supreme People's Procuratorate and the MPS on Legally Punishing Criminal Activities Infringing upon the Personal Information of Citizens which was issued in 2013, and the Interpretation of the Supreme People's Court and the Supreme People's Procuratorate on Several Issues regarding Legal Application in Criminal Cases Infringing upon the Personal Information of Citizens which was issued on May 8, 2017 and took effect on June 1, 2017, the following activities may constitute the crime of infringing upon a citizen's personal information: (1) providing a citizen's personal information to specified persons or releasing a citizen's personal information online or through other methods in violation of relevant national provisions; (2) providing legitimately collected information relating to a citizen to others without such citizen's consent (unless the information is processed, not traceable to a specific person and not recoverable); (3) collecting a citizen's personal information in violation of applicable rules and regulations when performing a duty or providing services; or (4) obtaining a citizen's personal information by purchasing, accepting or exchanging such information in violation of applicable rules and regulations.

Pursuant to the Notice of the General Office of the State Council on Issuing the Measures for the Management of Scientific Data issued by the General Office of the State Council on March 17, 2018, all entities and individuals shall comply with the relevant national laws and regulations as well as departmental rules in relation to collecting, producing, using and managing scientific data, and shall not carry out activities endangering the national security, social public interests and others' legitimate rights and interests by using scientific data.

The PRC Civil Code, which was issued by the NPC on May 28, 2020 and became effective on January 1, 2021, provides that a natural person's personal information shall be protected by law, and the processing of personal information shall be subject to the principle of legitimacy, rightfulness and necessity, with no excessive processing.

The PRC Data Security Law was promulgated by the NPC on June 10, 2021 and became effective on September 1, 2021. The PRC Data Security Law stipulates the measures to support and promote data security and development and establish and optimize the national data security management system, and clarifies organizations' and individuals' responsibilities in data security.

The Personal Data Protection Law (the "PDPL") was issued by NPC on August 20, 2021 and took effect on November 1, 2021, stipulates the scope of personal information and the ways of processing personal information, establishes rules for processing personal information and for transfer offshore, and clarifies the individual's rights and the processor's obligations in the processing of personal information. The PDPL also strengthens the punishment for those who illegally process personal information.

On July 7, 2022, the Cyberspace Administration of China published Outbound Data Transfer Security Assessment Measures, which became effective on September 1, 2022 and outlined the security assessment process for outbound data transfer.

Anti-bribery

According to the Anti-Unfair Competition Law of the PRC (the "Anti-Unfair Competition Law"), which was passed by the SCNPC on September 2, 1993, became effective on December 1, 1993 and was last amended on April 23, 2019, unfair competition refers to that in the course of production and operating activities, the operators disrupt the market competition order and damage the legitimate rights and interests of other operators or consumers in violation of the provisions of the Anti-unfair Competition Law. Pursuant to the Anti-unfair Competition Law, operators shall abide by the principle of voluntariness, equality, impartiality and integrity, and adhere to laws and business ethics during market transactions. Operators in violation of the Anti-unfair Competition Law shall bear corresponding civil, administrative or criminal liabilities depending on the specific circumstances.

Furthermore, pursuant to the Anti-Unfair Competition Law, business operators shall not use money and properties or other means to bribe the following organizations or individuals for the purpose of seeking transaction opportunities or competitive advantage: (1) staff of the counterparty; (2) organizations or individuals entrusted by the counterparty to handle the relevant matters; or (3) organizations or individuals who make use of their authority or influence to influence the transaction. Business operators may explicitly give discount to a counterparty, or pay commission to a middleman in their transactions. In such case, the business operators shall record the discount or commission in

its accounts truthfully. Business operators who receive discount or commission shall also record it in their accounts truthfully. Bribery committed by a staff member of a business operator shall be deemed as bribery committed by the business operator, unless the business operator has evidence to prove that the conduct of the staff member is irrelevant to seeking transaction opportunities or competitive advantage for the business operator. Where a business operator violates these provisions and conducts bribe, the regulatory authorities shall confiscate its illegal income and impose a fine ranging from RMB100,000 to RMB3,000,000. Severe violations shall have their business licenses revoked.

According to the Interim Provisions on the Prohibition of Commercial Bribery (the “Prohibition Commercial Bribery Provisions”), which was promulgated by the State Administration of Industry and Commerce on November 15, 1996, commercial bribery refers to an act of offering money or property or using other means by an operator to the other entity or individual for the purposes of selling or buying goods, among which “other means” refer to the means used to provide any types of benefits other than money or property, such as offering overseas or domestic travel. According to the Anti-Unfair Competition Law and the Prohibition Commercial Bribery Provisions, regulatory authorities may impose fines depending on the seriousness of the cases and if there is any illegal income, such income shall be confiscated.

Pharmaceutical companies involved in a criminal investigation or administrative proceedings related to bribery are listed in the Adverse Records of Commercial Briberies by its provincial health and family planning administrative department. Pursuant to the Provisions on the Establishment of Adverse Records of Commercial Briberies in the Medicine Purchase and Sales Industry which became effective in March 2014, provincial health and family planning administrative departments formulate the implementing measures for establishment of Adverse Records of Commercial Briberies. If a pharmaceutical company is listed in the Adverse Records of Commercial Briberies of a province for the first time, its production will not be allowed to be purchased by public medical institutions in this province within the next two years after the relevant list is published.

According to the Criminal Law of the PRC, which was last amended on December 29, 2023 and would be effective on March 1, 2024, whoever, for the purpose of seeking illegitimate benefits, gives money or property to a staff member of a company, an enterprise or any other entity, shall be sentenced to imprisonment or criminal detention and shall also be fined, depending on the amount involved. An act of giving money or any property to state functionaries to seek illegitimate benefits shall be considered a crime of offering bribes. Whoever commits the crime of offering bribes shall be sentenced to imprisonment or criminal detention and shall also be fined and subject to confiscation of property, depending on severity of the situation.

Regulations relating to national medical insurance program

National Medical Insurance Program The national medical insurance program was adopted pursuant to the Decision of the State Council on the Establishment of the Urban Employee Basic Medical Insurance Program issued by the State Council on December 14, 1998, under which all employers in urban cities are required to enroll their employees in the Urban Employee Basic Medical Insurance Program and the insurance premium is jointly contributed by the employers and employees. Pursuant to the Opinions on the Establishment of the New Rural Cooperative Medical System forwarded by the General Office of the State Council on January 16, 2003, China launched the New Rural Cooperative Medical System to provide medical insurance for rural residents in selected areas which has spread to the whole nation thereafter. The State Council promulgated the Guiding Opinions of the State Council about the Pilot Urban Resident Basic Medical Insurance on July 10, 2007, under which urban residents of the pilot district, rather than urban employees, may voluntarily join Urban Resident Basic Medical Insurance. In 2015, the PRC government announced the Outline for the Planning of the National Medical and Health Service System (2015-2020) which aims to establish a basic medical and health care system that covers both rural and urban citizens by 2020.

Regulations Relating to Importation and Exportation of Goods

According to the Administrative Provisions on the Recordation of Customs Declaration Entities of the PRC, promulgated by the General Administration of Customs of the PRC on November 19, 2021 and came into force on January 1, 2022, the consignee, consignor and customs declaration enterprise of import and export goods filed with the customs in accordance with these regulations may handle customs declaration business within the customs territory of the PRC. Consignors and consignees of imported and exported goods shall go through customs declaration entity recordation formalities with the competent customs departments in accordance with the applicable provisions.

[Table of Contents](#)

Consignors and consignors of import and export goods and customs declaration enterprises that apply for recordation shall obtain the qualification of market entities; among which, the consignees and consignors of import and export goods shall also obtain recordation of foreign trade operators if they apply for recordation.

Regulations relating to product liability

Pursuant to the Product Quality Law of the PRC promulgated on February 22, 1993 and latest amended on December 29, 2018 by the SCNPC, the seller shall be responsible for the repair, replacement or return of the product sold if (1) the product sold does not possess the properties for use that it should possess, and no prior and clear indication is given of such a situation; (2) the product sold does not conform to the applied product standard as carried on the product or its packaging; or (3) the product sold does not conform to the quality indicated by such means as a product description or physical sample. If a consumer incurs losses as a result of the purchased product, the seller shall compensate for such losses.

The Law of the PRC on the Protection of the Rights and Interests of Consumers was promulgated on October 31, 1993 and amended on August 27, 2009 and October 25, 2013 to protect consumers' rights when they purchase or use goods and accept services. All business operators must comply with this law when they manufacture or sell goods and/or provide services to customers. Under the amendments made on October 25, 2013, all business operators must pay attention to protecting customers' privacy and must strictly keep confidential any consumer information they obtain during their business operations. In addition, in extreme situations, medical product manufacturers and operators may be subject to criminal liability if their goods or services lead to the death or injuries of customers or other third parties.

Pursuant to the PRC Civil Code which was promulgated by the NPC on May 28, 2020 and became effective on January 1, 2021, where a patient suffers damage due to defects in drugs, he may seek compensation from the drug marketing authorization holder or also from the medical institution. Where the patient seeks compensation from the medical institution, the medical institution, after it has made the compensation, shall have the right to recover the compensation from the liable drug marketing authorization holder.

Regulations relating to foreign investment

Foreign investment

Investment activities in the PRC by foreign investors were principally governed by the Special Administrative Measures (Negative List) for Access of Foreign Investment (2021 version) (the "Negative List") and Catalogue of Industries for Encouraging Foreign Investment (2022 version) (the "Encouraging List"). The Negative List, which came into effect on January 1, 2022, sets out special administrative measures in respect of the access of foreign investments in a centralized manner, and the Encouraging List which came into effect on January 1, 2023, sets out the encouraged industries for foreign investment.

Foreign-invested enterprises

On December 29, 1993, the SCNPC issued the PRC Company Law (the "Company Law"), which was last amended on December 29, 2023 and will come into effect on July 1, 2024. The currently effective Company Law, which was amended on October 26, 2018, regulates the establishment, operation and management of corporate entities in China and classifies companies into limited liability companies and limited companies by shares. According to the Foreign Investment Law of the PRC, which was promulgated by the SCNPC on March 15, 2019 and came into effect as of January 1, 2020, the state shall implement the management systems of pre-establishment national treatment and negative list for foreign investment, and shall give national treatment to foreign investment beyond the negative list. Simultaneously, Sino-foreign Equity Joint Ventures of the PRC, the Wholly Foreign-owned Enterprises Law of the PRC and Sino-foreign Cooperative Joint Ventures of the PRC were repealed on January 1, 2020.

On December 30, 2019, MOFCOM and the SAMR issued the Measures for the Reporting of Foreign Investment Information, which came into effect on January 1, 2020 and replaced the Interim Measures for the Recordation Administration of the Incorporation and Change of Foreign-Invested Enterprises, for carrying out investment activities directly or indirectly in PRC, the foreign investors or foreign-invested enterprises shall submit investment information to the commerce authorities pursuant to these measures.

[Table of Contents](#)

Regulations relating to environmental protection and fire preventions

Environment protection

The Environmental Protection Law of the PRC (the “Environmental Protection Law”), which was promulgated by the SCNPC on December 26, 1989, came into effect on the same day and last amended on April 24, 2014, outlines the authorities and duties of various environmental protection regulatory agencies. The Ministry of Environmental Protection is authorized to issue national standards for environmental quality and emissions, and to monitor the environmental protection scheme of the PRC. Meanwhile, local environment protection authorities may formulate local standards which are more rigorous than the national standards, in which case, the concerned enterprises must comply with both the national standards and the local standards.

Environmental impact appraisal

According to the Administration Rules on Environmental Protection of Construction Projects, which was promulgated by the State Council on November 29, 1998, amended on July 16, 2017 and became effective on October 1, 2017, depending on the impact of the construction project on the environment, a construction employer shall submit an environmental impact report or an environmental impact statement, or file a registration form. As to a construction project, for which an environmental impact report or the environmental impact statement is required, the construction employer shall, before the commencement of construction, submit the environmental impact report or the environmental impact statement to the relevant authority at the environmental protection administrative department for approval. If the environmental impact assessment documents of the construction project have not been examined or approved upon examination by the approval authority in accordance with the law, the construction employer shall not commence the construction.

According to the Environmental Impact Appraisal Law of PRC (the “Environmental Impact Appraisal Law”), promulgated by the SCNPC on October 28, 2002, amended on July 2, 2016 and December 29, 2018, for any construction projects that have an impact on the environment, an entity is required to produce either a report, or a statement, or a registration form of such environmental impacts depending on the seriousness of effect that may be exerted on the environment.

Fire prevention design and acceptance

The Fire Prevention Law of the PRC (the “Fire Prevention Law”), was adopted on April 29, 1998 and last amended on April 29, 2021. According to the Fire Prevention Law, for special construction projects stipulated by the housing and urban-rural development authority of the State Council, the developer shall submit the fire safety design documents to the housing and urban-rural development authority for examination, while for construction projects other than those stipulated as special development projects, the developer shall, at the time of applying for the construction permit or approval for work commencement report, provide the fire safety design drawings and technical materials which satisfy the construction needs. According to Interim Regulations on Administration of Examination and Acceptance of Fire Control Design of Construction Projects, an examination system for fire prevention design and acceptance only applies to special construction projects, and for other projects, a record-filing and spot check system would be applied.

Regulations relating to employment, social securities and production safety

Employment

The major PRC laws and regulations that govern employment relationship are the Labor Law of the PRC (the “Labor Law”) (issued by the SCNPC on July 5, 1994, came into effect on January 1, 1995 and revised on August 27, 2009 and December 29, 2018), the Labor Contract Law of the PRC or the Labor Contract Law (promulgated by the SCNPC on June 29, 2007 and became effective on January 1, 2008, and then amended on December 28, 2012 and became effective on July 1, 2013) and the Implementation Rules of the Labor Contract Law of the PRC (the “Implementation Rules of the Labor Contract Law”) (issued by the State Council on September 18, 2008 and came into effect on the same day). According to the aforementioned laws and regulations, labor relationships between employers and employees must be established in written form. The laws and regulations above impose stringent requirements on the employers in relation to entering into fixed-term employment contracts, hiring of temporary employees and dismissal of employees.

[Table of Contents](#)

Social securities

According to the Social Insurance Law of PRC, which was issued by the SCNPC on October 28, 2010, came into effect on July 1, 2011 and revised on December 29, 2018, enterprises and institutions in the PRC shall provide their employees with welfare schemes covering pension insurance, unemployment insurance, maternity insurance, occupational injury insurance, medical insurance and other welfare plans. The employer shall apply to the local social insurance agency for social insurance registration within 30 days from the date of its formation. And it shall, within 30 days from the date of employment, apply to the social insurance agency for social insurance registration for the employee. Meanwhile, the Interim Regulation on the Collection and Payment of Social Insurance Premiums (issued by the State Council on January 22, 1999 and came into effect on the same day and was revised on March 24, 2019) prescribes the details concerning the social securities.

Housing provident fund

According to the Regulation Concerning the Administration of Housing Provident Fund, implemented on April 3, 1999 and amended on March 24, 2002 and March 24, 2019, any newly established entity shall make deposit registration at the housing accumulation fund management center within 30 days as of its establishment. After that, the entity shall open a housing accumulation fund account for its employees in an entrusted bank. Within 30 days as of the date an employee is recruited, the entity shall make deposit registration at the housing accumulation fund management center and transfer or seal up the employee's housing accumulation fund account in the bank mentioned above within 30 days from termination of the employment relationship.

Production safety

Pursuant to the Production Safety Law of the PRC, which was amended by the Standing Committee of the NPC on June 10, 2021 and came into effect on September 1, 2021, an enterprise shall (1) provide production safety conditions as stipulated in this law and other relevant laws, administrative regulations, national and industry standards, (2) establish a comprehensive production safety accountability system and production safety rules, (3) develop production safety standards to ensure production safety and (4) establish safety risk classification management and control system, and take corresponding control measures according to the safety risk classification. Any entity that fails to provide required production safety conditions is prohibited from engaging in production activities. The person-in-charge of an enterprise shall be fully responsible for the safety of production of the enterprise.

Regulations relating to intellectual properties

Patents

According to the Patent Law of the PRC (which was promulgated by the SCNPC on March 12, 1984, last amended on October 17, 2020 and came into effect on June 1, 2021) and the Implementing Rules of the Patent Law of the PRC (which was promulgated by the China Patent Bureau Council on January 19, 1985, last amended on December 11, 2023 by the State Council and came into effect on January 20, 2024), the term "invention-creations" refers to inventions, utility models and designs. The duration of a patent right for inventions, utility models and designs shall be 20 years, 10 years and 15 years, respectively, commencing from the filing date.

Trademarks

Pursuant to the Trademark Law of the PRC (which was promulgated on August 23, 1982, amended on April 23, 2019 and came into effect on November 1, 2019) and the Implementation Regulations of the Trademark Law of PRC (which was issued on August 3, 2002 and amended on April 29, 2014), the Trademark Office under the State Administration for Industry and Commerce of the PRC (the "Trademark Office") shall handle trademark registrations and grant a term of 10 years to registered trademarks, which may be renewed for an additional ten-year period upon request from the trademark owner. The Trademark Law of the PRC has adopted a "first-to-file" principle with respect to trademark registration. Where an application for trademark for which application for registration has been made is identical or similar to another trademark which has already been registered or is under preliminary examination and approval for use on the same kind of or similar commodities or services, the application for registration of such trademark may be rejected. Any person applying for the registration of a trademark may not prejudice the existing right of others, nor may any person register in advance a trademark that has already been used by another party and has already gained a

[Table of Contents](#)

“sufficient degree of reputation” through such party’s use. A trademark registrant may, by entering into a trademark licensing contract, license another party to use its registered trademark. Where another party is licensed to use a registered trademark, the licensor shall report the license to the Trademark Office for recordation, and the Trademark Office shall publish it. An unrecorded license may not be used as a defense against a third party in good faith.

Domain names

In accordance with the Measures for the Administration of Internet Domain Names, which was issued by the Ministry of Information Industry on August 24, 2017 and came into effect on November 1, 2017, the Ministry of Information Industry is responsible for supervision and administration of domain name services in the PRC. Communication administrative bureaus at provincial levels shall conduct supervision and administration of the domain name services within their respective administrative jurisdictions. Domain name registration services shall, in principle, be subject to the principle of “first apply, first register.” A domain name registrar shall, in the process of providing domain name registration services, ask the applicant for which the registration is made to provide authentic, accurate and complete identity information on the holder of the domain name and other domain name registration related information.

Regulations relating to foreign exchange and overseas investment

On January 29, 1996, the State Council promulgated the Administrative Regulations on Foreign Exchange of the PRC which became effective on April 1, 1996 and was amended on January 14, 1997 and August 5, 2008. Foreign exchange payments under current account items shall, pursuant to the administrative provisions of the foreign exchange control department of the State Council on payments of foreign currencies and purchase of foreign currencies, be made using self-owned foreign currency or foreign currency purchased from financial institutions engaging in conversion and sale of foreign currencies by presenting the valid document.

On November 19, 2012, the State Administration of Foreign Exchange (“SAFE”) issued the Circular of Further Improving and Adjusting Foreign Exchange Administration Policies on Foreign Direct Investment (the “SAFE Circular 59”), which came into effect on December 17, 2012 and was revised on May 4, 2015, October 10, 2018 and partially abolished on December 30, 2019. The SAFE Circular 59 aims to simplify the foreign exchange procedure and promote the facilitation of investment and trade. According to the SAFE Circular 59, the opening of various special purpose foreign exchange accounts, such as pre-establishment expenses accounts, foreign exchange capital accounts and guarantee accounts, the reinvestment of RMB proceeds derived by foreign investors in the PRC, and remittance of foreign exchange profits and dividends by a foreign-invested enterprise to its foreign shareholders no longer require the approval or verification of SAFE, as well multiple capital accounts for the same entity may be opened in different provinces. Later, SAFE promulgated the Circular on Further Simplifying and Improving Foreign Exchange Administration Policies in Respect of Direct Investment in February 2015, which was partially abolished in December 2019 and prescribed that the bank instead of SAFE can directly handle the foreign exchange registration and approval under foreign direct investment while SAFE and its branches indirectly supervise the foreign exchange registration and approval under foreign direct investment through the bank.

On October 23, 2019, SAFE promulgated the Notice on Further Facilitating Cross-Board Trade and Investment, which became effective on the same date (except for Article 8.2, which became effective on January 1, 2020) and was revised on December 4, 2023. The notice cancelled restrictions on domestic equity investments made with capital funds by non-investing foreign-funded enterprises. In addition, restrictions on the use of funds for foreign exchange settlement of domestic accounts for the realization of assets have been removed and restrictions on the use and foreign exchange settlement of foreign investors’ security deposits have been relaxed. Eligible enterprises in the pilot area are also allowed to use revenues under capital accounts, such as capital funds, foreign debts and overseas listing revenues for domestic payments without providing materials to the bank in advance for authenticity verification on an item-by-item basis, while the use of funds should be true, in compliance with applicable rules and conforming to the current capital revenue management regulations.

According to the Notice on Further Optimizing the Cross-border RMB Policy and Supporting the Stabilization of Foreign Trade and Foreign Investment, which was issued by the People’s Bank of China, the NDRC, MOFCOM, the State-owned Assets Supervision and Administration Commission of the State Council, the China Banking and Insurance Regulatory Commission and SAFE on December 31, 2020 and came into effect on February 4, 2021, the RMB income from the capital account of domestic institutions could be used within the business scope approved by the relevant state departments when the following requirements are met: (1) it shall not be used directly or indirectly

[Table of Contents](#)

for expenditures outside the business scope of the enterprise or the expenditures prohibited by national laws and regulations; (2) unless expressly provided otherwise, it shall not be used directly or indirectly for securities investment; (3) unless expressly permitted in the business scope, it shall not be used for giving out loans to the non-associated enterprises; and (4) it shall not be used for constructing or purchasing the real estate for non-self-use (except for real estate development enterprises). In addition, the non-investment oriented foreign investment enterprises could make domestic reinvestment with RMB capital in accordance with the law, provided they comply with current regulations and the domestic investment projects are true and compliant.

Regulations relating to M&A

According to the M&A Rules, which was jointly issued by MOFCOM, the State Assets Supervision and Administration Commission of State Council, SAT, the SAMR, the CSRC, and SAFE, on August 8, 2006 and amended by MOFCOM on June 22, 2009, among other things, (1) the purchase of an equity interest or subscription to the increase in the registered capital of non-foreign-invested enterprises, (2) the establishment of foreign-invested enterprises to purchase and operate the assets of non-foreign-invested enterprises, or (3) the purchase of the assets of nonforeign-invested enterprises and the use of such assets to establish foreign-invested enterprises to operate such assets, in each case, by foreign investors shall be subject to the M&A Rules. Particularly, application shall be made for examination and approval of the acquisition of any company in China affiliating to a domestic company, enterprise or natural person, which is made in the name of an overseas company established or controlled by such domestic company, enterprise or natural person.

Regulations relating to overseas listing

On February 17, 2023, the CSRC issued the Trial Administrative Measures for Overseas Listing and five supporting guidelines, which came into effect on March 31, 2023.

The Trial Administrative Measures for Overseas Listing provide that an overseas listing or offering is explicitly prohibited under any of the following circumstances: (1) such securities offering and listing is explicitly prohibited by provisions in laws, administrative regulations and relevant state rules of the PRC; (2) the intended securities offering and listing may endanger national security as reviewed and determined by competent authorities under the State Council in accordance with law; (3) the domestic company, its controlling shareholder(s) or the actual controller have committed relevant crimes such as corruption, bribery, embezzlement, misappropriation of property or undermining the order of the socialist market economy during the latest three years; (4) the domestic company is currently under investigations for suspicion of criminal offenses or major violations of laws and regulations, and no conclusion has yet been made thereof; or (5) there are material ownership disputes over equity held by the controlling shareholder(s) or by other shareholder(s) that are controlled by the controlling shareholder(s) and/or actual controller.

According to the Trial Administrative Measures for Overseas Listing, a filing-based regulatory regime is adopted to regulate both direct and indirect overseas securities offering and listing by the domestic companies. Direct overseas offering and listing by domestic companies refers to such overseas offering and listing by a joint-stock company incorporated domestically, while the indirect overseas offering and listing by domestic companies refers to the offering and listing by a company in the name of an overseas incorporated entity the major business operations of which are located domestically and such offering and listing is based on the underlying equity, assets, earnings or other similar rights of a domestic company. The Trial Administrative Measures for Overseas Listing also provide the criteria of indirect overseas offering and listing by domestic companies which shall be regulated. If the issuer meets both the following criteria, it will be deemed as indirect overseas offering and listing by domestic companies: (1) 50% or more of any of the issuer's operating revenue, total profit, total assets or net assets as documented in its audited consolidated financial statements for the most recent fiscal year is accounted for by domestic companies; and (2) the main parts of the issuer's business activities are conducted in mainland China, or its main place(s) of business are located in mainland China, or the majority of senior management staff in charge of its business operations and management are PRC citizens or domiciled in mainland China.

According to the Trial Administrative Measures for Overseas Listing, subsequent securities offering of an issuer in the same overseas market where it has previously offered and listed securities shall be filed with the CSRC within 3 working days after the offering is completed. Subsequent securities offering and listing of an issuer in other overseas markets shall be filed as initial public offering, under which filing application with the CSRC shall be submitted within 3 working days after the application documents for offering and listing are submitted overseas. A domestic company

[Table of Contents](#)

that seeks to directly or indirectly list its domestic assets in overseas markets through single or multiple acquisitions, share swaps, transfers of shares or other means, shall fulfil the filing procedure as an initial public offering. Where overseas application documents are not required, the filing shall be made within 3 working days after the first public disclosure of the specifics of the transaction is made by the listed company.

Regulations relating to taxation

Enterprise income tax

The Enterprise Income Tax Law of the PRC (the “EIT Law”), promulgated by the NPC on March 16, 2007, effective on January 1, 2008 and amended on February 24, 2017 and December 29, 2018, as well as the Implementation Rules of the EIT Law (the “Implementation Rules”), promulgated by the State Council on December 6, 2007, effective on January 1, 2008 and amended on April 23, 2019, are the principal law and regulation governing enterprise income tax in the PRC. According to the EIT Law and its Implementation Rules, enterprises are classified into resident enterprises and non-resident enterprises. Resident enterprises refer to enterprises that are legally established in the PRC, or are established under foreign laws but whose actual management bodies are located in the PRC, and non-resident enterprises refer to enterprises that are legally established under foreign laws and have set up institutions or sites in the PRC but with no actual management body in the PRC, or enterprises that have not set up institutions or sites in the PRC but have derived incomes from the PRC. A uniform income tax rate of 25% applies to all resident enterprises and non-resident enterprises that have set up institutions or sites in the PRC to the extent that such incomes are derived from their set-up institutions or sites in the PRC, or such income are obtained outside the PRC but have an actual connection with the set-up institutions or sites, and non-resident enterprises that have not set up institutions or sites in the PRC or that have set up institutions or sites but the incomes obtained by the said enterprises have no actual connection with the set-up institutions or sites, shall pay enterprise income tax at the rate of 10% in relation to their income sources from the PRC.

Value-added tax

The major PRC law and regulation governing value-added tax are the Interim Regulations on Value-added Tax of the PRC (issued on December 13, 1993 by the State Council, effective on January 1, 1994, and revised on November 10, 2008, February 6, 2016 and November 19, 2017), as well as the Implementation Rules for the Interim Regulations on Value-Added Tax of the PRC (issued on December 25, 1993 by the Ministry of Finance of the PRC (the “MOF”), came into effect on the same day and revised on December 15, 2008 and October 28, 2011), any entities and individuals engaged in the sale of goods, supply of processing, repair and replacement services, and import of goods within the territory of the PRC are taxpayers of Value-Added Tax (the “VAT”) and shall pay the VAT in accordance with the law and regulation. The rate of VAT for sale of goods is 17% unless otherwise specified, such as the rate of VAT for sale of transportation is 11%. With the VAT reforms in the PRC, the rate of VAT has been changed several times. The MOF and the SAT issued the Notice on Adjusting VAT Rates on April 4, 2018 to adjust the tax rates of 17% and 11% applicable to any taxpayer’s VAT taxable sale or import of goods to 16% and 10%, respectively, this adjustment became effect on May 1, 2018. Subsequently, the MOF, the SAT and the General Administration of Customs jointly issued the Announcement on Relevant Policies for Deepening the VAT Reform on March 20, 2019 to make a further adjustment, which came into effect on April 1, 2019. The tax rate of 16% applicable to the VAT taxable sale or import of goods shall be adjusted to 13%, and the tax rate of 10% applicable thereto shall be adjusted to 9%. Moreover, according to the Announcement of the SAT on the VAT Issues Concerning the Sale of Biological Products by Drug Trading Enterprises issued on May 28, 2012, if a drug trading enterprise which is a general taxpayer for VAT sells biological products, it could choose a simple method to calculate the VAT to pay based on the sales of biological products and a collection rate of 3%.

Laws and regulations in Singapore

Laws and regulations relating to clinical trials

In Singapore, the Health Sciences Authority (“HSA”), a statutory board of the Ministry of Health of Singapore, regulates the conduct of clinical trials of therapeutic products and medicinal products under the Health Products Act (Chapter 122D) and Medicines Act (Chapter 176) and their subsidiary legislations (including Health Products (Clinical

[Table of Contents](#)

Trials) Regulations (“HPCTR”) and the Medicines (Clinical Trials) Regulations 2016 (“MCTR,” together with the HPCTR, collectively, the “Regulations”), respectively. Certain types of clinical research such as observational clinical trials of therapeutic products and medicinal products and clinical trials on medical devices are not regulated by HSA.

The Regulations provide that every clinical trial must have one and only one sponsor. However, HSA may, in its discretion, allow more than one sponsor for a clinical trial. A “sponsor” is defined under the Regulations as a person who takes responsibility for the initiation, management or financing of a clinical trial. Under the Regulations, the sponsor of a clinical trial is required, among others:

- (1) in the case of clinical trial of medicinal products, to apply for and obtain a clinical trial certificate for each principal investigator of the clinical trial before the commencement of the trial;
- (2) in the case of clinical trial of medicinal products, to apply for and obtain authorization by HSA for the clinical trial or notify HSA of the clinical trial and receipt of HSA’s acceptance of the notification before the commencement of the trial;
- (3) not to make substantial amendments to the trial except with approval of HSA;
- (4) to notify HSA of the trial status, suspension, termination and conclusion, and submit final report regarding the trial status within stipulated timelines under respective Regulations;
- (5) to ensure that information in the investigator’s brochure for the trial is concise, objective and kept up to date;
- (6) to ensure that the clinical trial is conducted under supervision of qualified private investigator;
- (7) to ensure that the clinical trial is only conducted at the specified trial site;
- (8) to carry out functions of the sponsor in accordance with principles of good clinical practice (“GCP”) set out in the First Schedule of the respective Regulations;
- (9) to put and keep in place arrangements to ensure compliance with principles of GCP;
- (10) to notify HSA of serious breaches and urgent safety measures taken to protect subjects against immediate hazard within stipulated timelines under the respective Regulations;
- (11) to keep record of clinical trials;
- (12) to ensure that all investigational and auxiliary medicinal product used in the trial are labelled in accordance with the labelling requirements set out in Second Schedule of the respective Regulations; and
- (13) to report unexpected serious adverse drug reactions to HSA within the stipulated timelines under the respective Regulations.

The sponsor may delegate all or any of the sponsor’s functions under the Regulations to any person, but any such arrangement does not affect the responsibility of the sponsor.

HSA has power under the Regulations to suspend or terminate a clinical trial, or any part of a clinical trial if it has reasonable grounds to suspect that (a) any information provided in respect of any application for a clinical trial certificate for the trial is false or misleading; (b) any sponsor, principal investigator or person assisting the principal investigator has contravened, is contravening or is likely to contravene any condition to which any clinical trial certificate issued for the trial is subject or any provision of the Regulations; (c) any ground for the conduct of the trial on the basis of scientific validity is no longer applicable or true or (d) the continuance of the trial will compromise the safety of any subject of the trial. In such event, the sponsor and a principal investigator must ensure that the suspension or termination is adhered to by all persons involved in the trial.

A person who is guilty of an offence under MCTR shall be liable on conviction to a fine not exceeding \$5,000 or to imprisonment for a term not exceeding two years or to both.

A person who is guilty of an offence under HPCTR shall be liable on conviction to a fine not exceeding \$10,000 or \$20,000 depending on the offence or to imprisonment for a term not exceeding six or 12 months depending on the offence or to both.

Laws and regulations relating to clinical research material

The manufacture, import and supply of therapeutic products and medicinal products used as a clinical research material in clinical trials in Singapore is governed by the Health Products Act (Chapter 122D), Medicines Act (Chapter 176) and their subsidiary legislations (including Health Products (Therapeutic Products as Clinical Research Materials) Regulations 2016 (“HPTPCRM”), Medicines (Medicinal Products as Clinical Research Materials) Regulations 2016 (“MMPCRM”, together with the HPTPCRM, collectively, the “CRM Regulations”)), respectively.

The Health Products Act (Chapter 122D) and Medicines Act (Chapter 176) provides that no person shall import, manufacture, assemble or sell (by way of wholesale dealing) any health product or medicinal product without a valid license (product license, import license, manufacturer’s license or wholesale dealer’s license where applicable) and that health products must also not be supplied without product registration. Under the CRM Regulations, certain health product or medicinal products (including among others, those that are manufactured, assembled, imported or supplied as clinical research materials) are exempted from the above licensing requirements, subject to the importer or manufacturer (as the case may be) of clinical research materials giving notice of the import or supply (as the case may be) (“CRM Notification”) to HSA before importing or supplying (as the case may be) the clinical research materials in accordance with the requirements of the CRM Regulations.

According to the clinical trial guidance on clinical research materials published by HSA on 2 May 2017, sponsor of clinical trials (that are regulated by HSA and for which imported or locally manufactured clinical research material is to be used) should submit the CRM Notification on behalf of the importer or local manufacturer to HSA at the time of initial application for clinical trial certificate or authorization or notification (as the case may be) or where such information is unavailable at the time of application, by way of amendment to the application. Before the CRM Regulations came into force, clinical trial material import permits were issued to clinical trial sponsors to facilitate importation of medicinal products for use in the approved drug trials.

Under the CRM Regulations, the sponsor is required to ensure that clinical research materials are only used in accordance with the research protocol, and where the research requires the approval of an institutional review board (“IRB”), only after approval has been obtained from IRB. Unless otherwise allowed by HSA, the sponsor is also required to ensure that any unused clinical research material obtained for the research is disposed of or exported within six months of the conclusion or termination of the clinical research. The sponsor must keep records relating to all clinical research materials that are put to some other use, disposed of or exported for the prescribed period and produce the records for inspection when required by HSA and report unexpected serious adverse drug reactions to HSA within the stipulated timelines.

The import of clinical research materials comprising controlled drugs and psychotropic substances, poisons or radiopharmaceuticals into Singapore is subject to additional licensing requirements.

A person who is guilty of an offence under MMPCRM shall be liable on conviction to a fine not exceeding \$5,000 or to imprisonment for a term not exceeding two years or to both.

A person who is guilty of an offence under HPTPCRM shall be liable on conviction to a fine not exceeding \$10,000 or \$20,000 depending on the offence or to imprisonment for a term not exceeding six or 12 months depending on the offence or to both.

Laws and regulations relating to confidentiality of personal data collected and used in clinical trials

As stated in the First Schedule (principles of good clinical practice) of the Health Products (Clinical Trials) Regulations (“HPCTR”) and the Medicines (Clinical Trials) Regulations 2016 (“MCTR”, together with the HPCTR, collectively, the “Regulations”), the confidentiality of records that could identify clinical trial subjects must be protected, respecting the privacy and confidentiality rules in accordance with any applicable written law or rule or principle of law.

The Personal Data Protection Act 2012 establishes the Singapore regime for the protection of personal data (i.e., data, whether true or not, about an individual who can be identified from that data or other information accessible to the relevant organization) and seeks to ensure that organizations comply with a baseline standard of protection for personal data of individuals.

[Table of Contents](#)

The nine data protection obligations are summarized as follows:

- (1) purpose limitation obligation — personal data must be collected, used or disclosed only for purposes that a reasonable person would consider appropriate in the circumstances, and if applicable, have been notified to the individual concerned;
- (2) notification obligation — individuals must be notified of the purposes for the collection, use or disclosure of their personal data, prior to such collection, use or disclosure;
- (3) consent obligation — the consent of individuals must be obtained for any collection, use or disclosure of their personal data, unless exceptions apply. Additionally, an organization must allow the withdrawal of consent which has been given or is deemed to have been given;
- (4) access and correction obligations — when requested by an individual and unless exceptions apply, an organization must: (i) provide that individual with access to his personal data in the possession or under the control of the organization and information about the ways in which his personal data may have been used or disclosed during the past year; and/or (ii) correct an error or omission in his personal data that is in the possession or under the control of the organization;
- (5) accuracy obligation — an organization must make reasonable efforts to ensure that personal data collected by or on its behalf is accurate and complete if such data is likely to be used to make a decision affecting the individual or if such data will be disclosed to another organization; and
- (6) protection obligation — an organization must implement reasonable security arrangements for the protection of personal data in its possession or under its control;
- (7) retention limitation obligation — an organization must not keep personal data for longer than it is necessary to fulfil: (i) the purposes for which it was collected; or (ii) a legal or business purpose;
- (8) transfer limitation obligation — personal data must not be transferred out of Singapore except in accordance with the requirements prescribed under the PDPA; and
- (9) openness obligation — an organization must implement the necessary policies and procedures in order to meet the obligations under the PDPA and shall make information about its policies and procedures publicly available.

Non-compliance may lead to financial penalties, civil liability or criminal liability. The Singapore regulator, the Personal Data Protection Commission, also has broad powers to order the organizations to comply with the provisions of the PDPA.

MANAGEMENT'S DISCUSSION AND ANALYSIS OF FINANCIAL CONDITION AND RESULTS OF OPERATIONS

The following discussion and analysis provide information which YS Biopharma's management believes is relevant to an assessment and understanding of YS Group's results of operations and financial condition. This discussion and analysis should be read together with YS Group's financial statements and notes thereto included elsewhere in this prospectus. In addition to historical financial information, this discussion contains forward-looking statements based upon YS Group's current expectations that involve risks and uncertainties. YS Group's actual results could differ materially from such forward-looking statements as a result of various factors, including those set forth under "Risk Factors" and elsewhere in this prospectus.

Overview

YS Group is a global biopharmaceutical company dedicated to discovering, developing, manufacturing and commercializing new generations of vaccines and therapeutic biologics for infectious diseases and cancer.

YS Group commercializes vaccines with significant revenue and growth potential. YS Group takes pride in YS Group's marketed vaccine product, YSJA™ rabies vaccine, which was the first aluminum-free lyophilized rabies vaccine launched in China. As of the date of this prospectus, approximately 102.0 million doses of YSJA™ rabies vaccine were administered for post-exposure protection against rabies. With commercialization, YSJA™ rabies vaccine achieved production scalability and market recognition. Since YS Group commenced the sales of YSJA™ rabies vaccine in October 2020 and to September 30, 2023, YS Group had sold more than 23.5 million doses to 1,718 county-level CDCs in China.

In addition to the commercialized YSJA™ rabies vaccine, YS Group also has a pipeline of vaccine candidates powered by YS Group's proprietary PIKA immunomodulating technology platform. YS Group's proprietary PIKA immunomodulating technology platform is core to the discovery and development of innovative biologics and will continue to be instrumental to YS Group's success. As of the date of this prospectus, YS Group have eight innovative product candidates: (1) four product candidates under various clinical development stages, including PIKA rabies vaccine, PIKA recombinant COVID-19 vaccine, PIKA YS-ON-001 and PIKA YS-HBV-001, and (2) four preclinical stage product candidates, targeting HBV, rabies, influenza and cancer with enormous medical demand. In addition, YS Group is working on therapeutic targets and products at the discovery stage. YS Group has about 70 patents across more than 30 countries and regions relating to its PIKA immunomodulating technology and prophylactic and therapeutic product innovations. YS Group believes that its PIKA immunomodulating technology platform has the potential to nurture a wide variety of innovative vaccines and therapeutic biologics.

As of September 30, 2023, YS Group had an accumulated deficit of \$285.3 million. YS Group funded its operations primarily with proceeds from revenues generated from the sales of its marketed product, YSJA™ rabies vaccine, and borrowings under its loan facilities.

Response to COVID-19

The extent to which the COVID-19 pandemic impacts YS Group's business, prospects and results of operations will depend on future developments, which are highly uncertain and cannot be predicted, including, but not limited to, the pace of global economic recovery, shifts in supply chains, changes in market behavior, and adaptations to new norms in the post-pandemic world. The lingering impact of COVID-19 pandemic could limit the ability of customers, suppliers, vendors and business partners to perform their obligations. YS Group cannot accurately forecast the potential impact of additional outbreaks, further shelter-in-place or other government restrictions implemented in response to such outbreaks, or the impact on the ability of YS Group's suppliers and other business partners to remain in business as a result of the lingering impact of the pandemic or any additional outbreaks. See "Risk Factors — Risks Related to YS Group's General Operations — YS Group could be adversely affected by the ongoing global impacts and uncertainties of the COVID-19 pandemic or similar pandemics in the future."

Key Factors Affecting Results of Operations

If the vaccine industry in China does not grow as expected or declines, the results of operations could be materially and adversely affected. If YS Group's marketed product and product candidates as well as the related manufacturing, storage, testing, delivery and other procedures do not meet the required quality standards, YS Group's business could be harmed, and its revenue and profitability could be materially and adversely affected.

Preclinical or clinical trials involve a lengthy and expensive process with uncertain outcomes. YS Group may not be able to achieve its projected development goal of its product candidates in a timely manner or at all, which may materially and adversely affect YS Group's business, financial condition, results of operations and prospects.

The biopharmaceutical industry is highly regulated. The relevant regulations and policies are complex and regional and subject to changes from time to time. YS Group's ability to obtain and maintain these regulatory approvals is uncertain. Any change in government regulations and policies may place additional burdens on YS Group's business and have a material adverse effect on YS Group's financial condition and results of operations.

YS Group's ability to increase the sales of its marketed product

YS Group commenced the production of its marketed product, YSJA™ rabies vaccine with its GMP-compliant manufacturing facilities in February 2020 and the sales and marketing in October 2020. From October 2020 to September, 2023, YS Group sold approximately 23.5 million doses of product to 1,718 county-level CDCs in China. The sales volume of YS Group's marketed product is expected to have a significant impact on its results of operations. YS Group's ability to increase the sales of its marketed product depends, in part, on whether YS Group is able to effectively implement its marketing strategies. YS Group intends to drive the full-scale commercialization of YSJA™ rabies vaccine to capture the significant unmet demand for rabies vaccine in China and Southeast Asia. YS Group plans to expand its manufacturing facilities by establishing manufacturing facilities in Shenyang (China) and Singapore and enhance YS Group's sales efforts by expanding its commercialization team, marketing service providers and county-level CDC coverage.

YS Group's ability to commercialize its product candidates

YS Group's business and results of operations will be dependent on the receipt of regulatory approval for and successful commercialization of its product candidates. Leveraging its proprietary PIKA immunomodulating technology platform, YS Group has developed a robust pipeline of product candidates targeting viral infections and cancer, including four clinical stage candidates and four preclinical candidates. YS Group expects PIKA rabies vaccine to lead and expedite its progress in the development and commercialization of existing pipeline products. YS Group believes its accumulated experience and resources in vaccine sales, manufacture and commercialization will be a strong driving force for the market launch of PIKA rabies vaccine and lay a solid foundation for YS Group's future expansion. For YS Group's other pipeline candidates, YS Group plans to strategically accelerate their development and commercialization based on its PIKA immunomodulating technology to realize YS Group's full potential in other important prophylactic and therapeutic areas.

YS Group's ability to optimize its cost structure

YS Group's results of operations are significantly affected by its costs and expenses. During the three fiscal years ended March 31, 2023 and the six months ended September 30, 2023, YS Group's results of operations were significantly affected by its R&D expenses, administrative expenses, selling and marketing expenses and other expenses. YS Group expects that costs of sales and selling and marketing expenses will have a significant impact on its results of operations in the future as YS Group started to sell YSJA™ rabies vaccine in October 2020. YS Group also expects that its R&D and administrative expenses, among others, will continue to have a significant impact on its financial performance.

[Table of Contents](#)

R&D activities are central to YS Group's business model. The development of YS Group's product candidates requires significant investment of resources over a prolonged period of time. YS Group devoted significant resources to R&D activities. For the fiscal year ended March 31, 2021, 2022 and 2023 and the six months ended September 30 2023, YS Group's R&D expenses were RMB94.4 million, RMB 211.2 million, RMB318.7 million (\$46.4 million) and RMB178.9 million (\$24.9 million), respectively. YS Group's current R&D activities primarily relate to the clinical advancement of its product candidates. YS Group expects its R&D expenses to continue to increase for the foreseeable future as YS Group progresses its product candidates, either from preclinical trials to clinical trials, or further into more advanced stages of clinical trials, and as YS Group continues to support the clinical trials of its product candidates as treatments for additional indications.

YS Group's administrative expenses primarily included employee benefits expenses primarily relating to salaries, share-based payment and other welfare for its administrative employees, depreciation and amortization expenses, and professional service fees. YS Group expects that its administrative expenses will increase as YS Group expands its operations to support its growing business.

YS Group began the sales and marketing of its marketed product in October 2020 and has a robust pipeline of product candidates from preclinical to late-stage, YS Group intends to leverage its in-house commercialization team and external service providers to expand its sales network and anticipate that its selling and marketing expenses will increase in the future to support the implementation of its sales plan.

YS Group expects its cost structure to evolve as it continues to develop and expand its business. As the clinical trials of its product candidates continue to progress and as it gradually brings its product pipeline to commercialization, YS Group expects to incur additional costs in relation to raw materials procurement, manufacturing, sales and marketing, among other things. YS Group also anticipates increasing legal, compliance, accounting, insurance, and investor and public relations expenses associated with being a public company.

YS Group's ability to maintain adequate funding for its operations

YS Group funded its operations primarily with proceeds from revenues generated from the sales of its marketed product, YSJA™ rabies vaccine, and borrowings under its loan facilities. Going forward, in the event of a successful commercialization of one or more of its product candidates, YS Group expects to fund its operations in part with revenue generated from sales of its marketed product. However, with the continuing expansion of its business, YS Group may require further funding through public or private offerings, debt financing, collaboration and licensing arrangements or other sources. Any fluctuation in the funding for YS Group's operations will impact its cash flow plan and results of operations.

Components of Results of Operations

Revenue

YS Group primarily generates revenue from the sales of YSJA™ rabies vaccine. YS Group typically recognizes revenue when its customers accept the rabies vaccine products, upon which YS Group has fulfilled the associated performance obligation.

Cost of revenue

YS Group's cost primarily consists of material, direct labor and production overheads. Depreciation of property, plant and equipment attributable to manufacturing activities and license amortization are capitalized as part of inventory and expensed as cost of revenue when product is sold. YS Group anticipates its direct costs associated with rabies vaccine will increase over the time mainly because the price of direct raw materials is rising.

Operating expenses

Selling and Marketing expenses

Selling and marketing expenses primarily consisted of employee benefits, travel and entertainment, promotion and marketing service fees and other marketing expenses. Employee benefits primarily included salaries, share-based payment and other welfare for YS Group's commercialization staff. Traveling and entertainment primarily are such

[Table of Contents](#)

expenses incurred by YS Group's commercialization staff in their sales activities. Promotion and marketing service fees primarily are the costs YS Group incurred to engage marketing service providers for the commercialization of YSJA™ rabies vaccines.

General and administrative expenses

General and administrative expenses primarily consisted of employee benefits expenses, depreciation and amortization, provision for trade receivables and inventories, professional service fees and other expense. Employee benefits expenses primarily included salaries, share-based payment and other welfare for YS Group's administrative staff. Depreciation and amortization primarily consisted of depreciation expenses for property, plant and equipment and right-of-use assets and amortization expenses for intangible assets used for administrative purpose.

Research and development expenses

R&D expenses primarily consisted of employee benefits, testing and clinical trial expenses, consulting service fees, depreciation and amortization, office and leasing expenses and other expenses. Employee benefits primarily included salaries, share-based payment and other welfare for YS Group's R&D employees. Testing and clinical trial expenses primarily are costs YS Group incurred in conducting clinical trials for its product candidates, including in-house testing fees, purchase of raw materials and consumables, and engagement of clinical trial sites and principal investigators. Consulting service fees primarily are third-party contracting costs with respect to the engagement of CROs and CRCs, and testing and processing services fees charged by such third parties. Depreciation and amortization primarily consisted of depreciation for property, plant and equipment and amortization expenses for intangible assets used for R&D purpose.

Income tax expense

YS Group is subject to profit tax on an entity basis on profits arising in or sourced from the jurisdictions where members of YS Group are domiciled and operate.

Cayman Islands. Under the current laws of the Cayman Islands, YS Biopharma is not subject to tax on income or capital gains. In addition, upon payments of dividends by YS Biopharma to its shareholders, no Cayman Islands withholding tax is imposed.

Hong Kong. Under the Hong Kong tax laws, Yisheng Hong Kong is exempted from profit tax on its foreign-sourced income and there are no withholding taxes in Hong Kong on remittance of dividends.

Singapore. The subsidiary incorporated in Singapore files separate income tax returns in Singapore at Singapore statutory income tax rate of 17%.

China. Under the Enterprise Income Tax ("EIT") Law of the PRC, domestic enterprises and Foreign Investment Enterprises (the "FIE") are usually subject to a unified 25% EIT rate while preferential tax rates, tax holidays, and even tax exemption may be granted on case-by-case basis. The PRC tax authorities grant preferential tax treatment to High and New Technology Enterprises ("HNTEs"). Under this preferential tax treatment, HNTEs are entitled to an income tax rate of 15%, subject to a requirement that they re-apply for HNTE status every three years. Since Liaoning Yisheng and Beijing Yisheng were approved as an HNTE in December 2021 and December 2022, Liaoning Yisheng and Beijing Yisheng are entitled to a reduced income tax of 15% and is able to enjoy the reduced income tax rate in the next three years.

United States. The subsidiary incorporated in Maryland, United States was subject to statutory United States federal corporate income tax rate of 21% and state income tax rate of 8.25% in Maryland during the reported fiscal periods.

Philippines. The subsidiary incorporated in Philippines is subject to income tax rate at 20%.

Results of Operations

The following table summarizes the results of YS Group's operations for the period as indicated and provides information regarding the percentage increase or decrease during such periods. This information should be read together with YS Group's condensed consolidated financial statements and related notes included elsewhere in this prospectus. The operating results in any period are not necessarily of the results that may be expected for any future period.

	Fiscal Year Ended March 31,					
	2021		2022		Variance	
	RMB	%	RMB	%	RMB	%
Revenues	257,015,929	100.0	502,949,894	100.0	245,933,965	95.7
Cost of revenues	59,656,877	23.2	117,066,090	23.3	57,409,213	96.2
Gross profit	<u>197,359,052</u>	<u>76.8</u>	<u>385,883,804</u>	<u>76.7</u>	<u>188,524,752</u>	<u>95.5</u>
Operating expenses:						
Selling and marketing	73,485,259	28.6	185,999,704	37.0	112,514,445	153.1
General and administrative	155,334,386	60.4	107,620,500	21.4	(47,713,886)	(30.7)
Research and development	94,387,144	36.7	211,222,263	42.0	116,835,119	123.8
Total operating expenses	<u>323,206,789</u>	<u>125.7</u>	<u>504,842,467</u>	<u>100.4</u>	<u>181,635,678</u>	<u>56.2</u>
Loss from operations	<u>(125,847,737)</u>	<u>(48.9)</u>	<u>(118,958,663)</u>	<u>(23.7)</u>	<u>6,889,074</u>	<u>(5.5)</u>
Other income (expenses):						
Late fees related to income tax	(11,464,741)	(4.5)	—	—	11,464,741	(100.0)
Late fees related to tax other than income tax	(7,261,947)	(2.8)	(231,231)	0.0	7,030,716	(96.8)
Late fees related to social insurance	(7,701,793)	(3.0)	(1,852,378)	(0.4)	5,849,415	(75.9)
Government grants	3,530,405	1.4	23,020,413	4.6	19,490,008	552.1
Financial expense, net	(29,689,927)	(11.6)	(2,717,433)	(0.5)	26,972,494	(90.8)
Other income, net	4,063,743	1.6	(327,987)	(0.1)	(4,391,730)	(108.1)
Total other income (expense), net	<u>(48,524,260)</u>	<u>(18.9)</u>	<u>17,891,384</u>	<u>3.6</u>	<u>66,415,644</u>	<u>(136.9)</u>
Loss before income taxes	<u>(174,371,997)</u>	<u>(67.8)</u>	<u>(101,067,279)</u>	<u>(20.1)</u>	<u>73,304,718</u>	<u>(42.0)</u>
Provision for income taxes	(17,454,245)	(6.8)	(4,937,122)	(1.0)	12,517,123	(71.7)
Net loss	<u>(191,826,242)</u>	<u>(74.6)</u>	<u>(106,004,401)</u>	<u>(21.1)</u>	<u>85,821,841</u>	<u>(44.7)</u>

[Table of Contents](#)

	Fiscal Year Ended March 31,						
	2022		2023			Variance	
	RMB	%	RMB	US\$	%	RMB	%
Revenues	502,949,894	100.0	687,201,070	100,004,521	100.0	184,251,176	36.6
Cost of revenues	117,066,090	23.3	153,360,262	22,317,660	22.3	36,294,172	31.0
Gross profit	385,883,804	76.7	533,840,808	77,686,861	77.7	147,957,004	38.3
Operating expenses:							
Selling and marketing	185,999,704	37.0	272,927,356	39,717,589	39.7	86,927,652	46.7
General and administrative	107,620,500	21.4	81,595,277	11,874,103	11.9	(26,025,223)	(24.2)
Research and development	211,222,263	42.0	318,700,526	46,378,702	46.4	107,478,263	50.9
Total operating expenses	504,842,467	100.4	673,223,159	97,970,394	98.0	168,380,692	33.4
Loss from operations	(118,958,663)	(23.7)	(139,382,351)	(20,283,533)	(20.3)	(20,423,688)	17.2
Other income (expenses):							
Late fees related to income tax	(231,231)	0.0	(3,603)	(524)	0.0	227,628	(98.4)
Late fees related to social security insurance	(1,852,378)	(0.4)	(747,609)	(108,795)	(0.1)	1,104,769	(59.6)
Government grants	23,020,413	4.6	26,072,517	3,794,187	3.8	3,052,104	13.3
Financial expenses, net	(2,717,433)	(0.5)	(30,857,673)	(4,490,544)	(4.5)	(28,140,240)	1,035.5
Fair value changes of warrant liability	—	0.0	21,358	3,108	0.0	21,358	100.0
Other income (expense), net	(327,987)	(0.1)	551,760	80,295	0.1	879,747	268.2
Total other income (expense), net	17,891,384	3.6	(4,963,250)	(722,273)	(0.7)	(22,854,634)	127.7
Loss before income taxes	(101,067,279)	(20.1)	(144,345,601)	(21,005,806)	(21.0)	(43,278,322)	42.8
Provision for income taxes	(4,937,122)	(1.0)	(1,133,504)	(164,952)	(0.2)	3,803,618	(77.0)
Net Loss	(106,004,401)	(21.1)	(145,479,105)	(21,170,758)	(21.2)	(39,474,704)	37.2

	Six Months Ended September 30,					
	2022		2023		Variance	
	(Unaudited)		(Unaudited)		(Unaudited)	
	RMB	%	RMB	%	RMB	%
Revenues	399,534,723	100.0	273,092,454	100.0	(126,442,269)	(31.6)
Cost of revenues	93,700,779	23.5	52,187,142	19.1	(41,513,637)	(44.3)
Gross profit	305,833,944	76.5	220,905,312	80.9	(84,928,632)	(27.8)
Operating expenses:						
Selling and marketing	150,228,079	37.6	157,700,204	57.7	7,472,125	5.0
General and administrative	49,587,013	12.4	67,610,523	24.8	18,023,510	36.3
Research and development	123,861,107	31.0	178,853,200	65.5	54,992,093	44.4
Total operating expenses	323,676,199	81.0	404,163,927	148.0	80,487,728	24.9
Loss from operations	(17,842,255)	(4.5)	(183,258,615)	(67.1)	(165,416,360)	927.1
Other income (expenses):						
Late fees for social insurance	(299,417)	(0.1)	(446,176)	(0.2)	(146,759)	49.0
Government grants	22,456,691	5.6	14,627,559	5.4	(7,829,132)	(34.9)
Interest income	266,433	0.1	1,957,620	0.7	1,691,187	634.8
Interest expense	(15,215,867)	(3.8)	(14,926,098)	(5.5)	289,769	(1.9)
Fair value changes of warrant liability	—	—	6,851,308	2.5	6,851,308	100.0
Other (expense) income, net	74,675	—	(148,749)	(0.1)	(223,424)	(299.2)
Total other income, net	7,282,515	1.8	7,915,464	2.8	632,949	8.7
Loss before income taxes	(10,559,740)	(2.7)	(175,343,151)	(64.3)	(164,783,411)	1,560.5
Benefit (Provision) for income taxes	(565,625)	(0.1)	820,353	0.3	1,385,978	(245.0)
Net loss	(11,125,365)	(2.8)	(174,522,798)	(64.0)	(163,397,433)	1,468.7

Six months ended September 30, 2023 compared to six months ended September 30, 2022.

Revenue

YS Group's revenue decreased by 31.6% from RMB399.5 million for the six months ended September 30, 2022 to RMB273.1 million (\$38.0 million) for the six months ended September 30, 2023, primarily due to COVID-related disruptions affecting our manufacturing operations, and production, which reduced batch approvals and doses available for sale; offset by increases in product price by approximately RMB3 per dose. The increase in production batches led to an increase in raw materials consumption, while sales volume and revenue decreased due to the decrease in batch approvals which resulting in a decrease in doses available for sale. YS Group sold approximately 3.6 million doses of product to 1,011 county-level CDCs for the six months ended September 30, 2023, compared to 5.4 million doses of product to 1,197 county-level CDCs for the six months ended September 30, 2022.

Cost of revenue

YS Group's cost of revenue primarily consisted of raw material, staffing, manufacturing and depreciation. The cost decreased by 44.3% from RMB93.7 million for the six months ended September 30, 2022 to RMB52.2 million (\$7.3 million) for the six months ended September 30, 2023. The decrease in costs was attributable primarily to (1) the decrease in headcount of production staff resulting in decrease in unit production cost of RMB0.2; (2) increase in production batches resulting in decrease in unit production cost of RMB0.3; and (3) decrease in sales volume of 1.9 million doses of YSJA™ rabies vaccine products.

Gross profit and gross margin

YS Group's gross profit decreased by 27.8% from RMB305.8 million for the six months ended September 30, 2022 to RMB220.9 million (\$30.8 million) for the six months ended September 30, 2023. The decrease in gross profit was due to the decrease in revenue.

Selling and marketing expenses

Selling and marketing ("S&M") expenses increased by 5.0% from RMB150.2 million for the six months ended September 30, 2022 to RMB157.7 million (\$22.0 million) for the six months ended September 30, 2023. The increase in S&M expenses was primarily due to the increase in promoting and marketing service fees, approximately RMB8.0 million, to promote the YSJA™ rabies vaccine products continuously.

The following table is a breakdown of YS Group's S&M expenses in absolute amount and as a percentage of the total S&M expenses for the periods indicated.

	Six Months Ended September 30,					
	2022		2023		Variance	
	RMB	%	RMB	%	RMB	%
Promoting and marketing service fees	138,166,922	92.0	146,184,485	92.7	8,017,563	5.8
Employee benefits	11,086,976	7.4	9,182,813	5.8	(1,904,163)	(17.2)
Other	974,181	0.6	2,332,906	1.5	1,358,725	139.5
Total	150,228,079	100.0	157,700,204	100.0	7,472,125	5.0

General and administrative expenses

General and administrative expenses increased by 36.3% from RMB49.6 million for the six months ended September 30, 2022 to RMB67.6 million (\$9.4 million) for the six months ended September 30, 2023, primarily because (1) increase of RMB5.6 million in professional service fees due to the Company's status as a publicly-listed entity; (2) increase of RMB3.9 million in the salary of management; and (3) increase of RMB9.7 million in provision for trade receivables and inventories.

[Table of Contents](#)

Our bad debt expenses were RMB5.2 million for the six months ended September 30, 2023, a decrease of RMB1.3 million or 19.6% from RMB6.4 million for 2022. Bad debt expenses are determined based on individual account analysis, historical collection trend, and best estimate of specific losses on individual exposures. We deemed accounts receivables and other receivables as uncollectible after all means of collection have been exhausted and the likelihood of collection is not probable.

The following table sets forth a breakdown of our general and administrative expenses in absolute amount and as a percentage of the total general and administrative expense for the periods indicated.

Six Months Ended September 30,						
	2022		2023		Variance	
	RMB	%	RMB	%	RMB	%
Employee benefits	20,634,246	41.6	24,476,212	36.2	3,841,966	18.6
Depreciation and amortization	3,500,469	7.1	3,028,770	4.5	(471,699)	(13.5)
Professional service fees	5,048,114	10.2	10,646,293	15.7	5,598,179	110.9
Office	1,329,449	2.7	1,045,207	1.5	(284,242)	(21.4)
Provision for trade receivables	6,447,110	13.0	5,180,717	7.7	(1,266,393)	(19.6)
Provision for obsolete inventories	(323,492)	(0.7)	10,678,694	15.8	11,002,186	(3,401.1)
Taxes and surcharges	3,196,939	6.4	3,220,434	4.8	23,495	0.7
Bank charges and exchange difference	5,120,896	10.3	4,363,757	6.5	(757,139)	(14.8)
Other	4,633,282	9.4	4,970,439	7.3	337,157	7.3
Total	49,587,013	100.0	67,610,523	100.0	18,023,510	36.3

Research and development expenses

R&D expenses increased by 44.4% from RMB123.9 million for the six months ended September 30, 2022 to RMB178.9 million (\$24.9 million) for the six months ended September 30, 2023. The increase in R&D expenses was primarily attributable to increase in testing and clinical trial fees associated with COVID-19, PIKA rabies, and hepatitis B vaccines.

The following table sets forth a breakdown of our R&D expenses in amount and as a percentage of the total R&D expenses for the periods indicated.

Six Months Ended September 30,						
	2022		2023		Variance	
	RMB	%	RMB	%	RMB	%
Testing and clinical trial fees	69,020,560	55.7	127,888,856	71.5	58,868,296	85.3
Consulting service fees	8,411,505	6.8	7,484,440	4.2	(927,065)	(11.0)
Employee benefits	33,812,314	27.3	29,791,998	16.7	(4,020,316)	(11.9)
Depreciation and amortization	6,323,641	5.1	9,746,532	5.4	3,422,891	54.1
Office and leasing	588,586	0.5	582,221	0.3	(6,365)	(1.1)
Other	5,704,501	4.6	3,359,153	1.9	(2,345,348)	(41.1)
Total	123,861,107	100.0	178,853,200	100.0	54,992,093	44.4

The following table below sets forth a breakdown of expenses for our key R&D projects.

Six Months Ended September 30,						
	2022		2023		Variance	
	RMB	%	RMB	%	RMB	%
PIKA Recombinant COVID-19 vaccine	82,214,199	66.4	85,778,557	48.0	3,564,358	4.3
PIKA rabies vaccine	17,519,659	14.1	47,220,570	26.4	29,700,911	169.5
PIKA YS-ON-001	4,854,187	3.9	4,632,465	2.6	(221,722)	(4.6)
PIKA HBV vaccines	5,940,696	4.8	18,546,080	10.4	12,605,384	212.2
PIKA adjuvant	4,054,248	3.3	2,933,244	1.6	(1,121,004)	(27.7)
YSJA™ rabies vaccine	4,275,750	3.5	16,719,122	9.3	12,443,372	291.0
Other	5,002,368	4.0	3,023,162	1.7	(1,979,206)	(39.6)
Total	123,861,107	100.0	178,853,200	100.0	54,992,093	44.4

Other income, net

YS Group recorded other income, net of RMB7.9 million (\$1.1 million) for the six months ended September 30, 2023, as compared to other income, net of RMB7.3 million for the six months ended September 30, 2022, primarily attributable to (1) a decrease of RMB7.8 million in government grants, for it was granted one-time in 2022; (2) an increase of RMB1.9 million in interest income; and (3) an increase of RMB6.9 million in fair value changes of warrant liability.

Income tax expense

YS Group's PRC subsidiaries are subject to income taxes in China on their taxable income calculated at a tax rate in accordance with the relevant income tax laws and regulations. YS Group determines deferred taxes for each tax-paying entity in each tax jurisdiction. The potential tax benefits arising from the losses incurred by the subsidiaries have been recorded in our financial statements. YS Group's income tax benefit increased from tax expense of RMB0.6 million for the six months ended September 30, 2022 to RMB0.8 million (\$0.1 million) for the six months ended September 30, 2023, primarily due to the increase in deferred tax assets from deferred government grants.

YS Group evaluates our valuation allowances requirements at each reporting period by reviewing all available evidence, both positive and negative, and considering whether, based on the weight of that evidence, a valuation allowance is needed. When a change in circumstances causes a change in management's judgment about the ability to realize deferred tax assets, the impact of the change on the valuation allowance is generally reflected in income from operations. The future realization of the tax benefit of an existing deductible temporary difference ultimately depends on the existence of sufficient taxable income of the appropriate character within the carry forward period available under applicable tax law.

Net loss

As a result of the foregoing, YS Group recognized net loss of RMB174.5 million (\$24.3 million) and RMB11.1 million for the six months ended September 30, 2023 and 2022, respectively.

Fiscal year ended March 31, 2023 compared to fiscal year ended March 31, 2022.

Revenue

YS Group's revenue increased by 36.6% from RMB502.9 million for the fiscal year ended March 31, 2022 to RMB687.2 million (\$100.0 million) for the fiscal year ended March 31, 2023. The increase was primarily due to (1) the sales volume increased due to the expansion of CDC and hospital access resulting from the professional promotion and doctors' recognition; and (2) the product price increased by approximately RMB2 per dose.

Cost of revenue

YS Group's cost of revenue primarily consisted of raw material costs, staff costs, manufacturing costs and depreciation expenses. The cost increased by 31.0%, from RMB117.1 million for the fiscal year ended March 31, 2022 to RMB153.4 million (\$22.3 million) for the fiscal year ended March 31, 2023. The increase in costs was attributable primarily to the increase in sales volume of YSJA™ rabies vaccine products.

Gross profit and gross margin

YS Group's gross profit increased by 38.3%, from RMB385.9 million for the fiscal year ended March 31, 2022 to RMB533.8 million (\$77.7 million) for the fiscal year ended March 31, 2023. The increase in gross profit was primarily due to the increase in revenue and unit price. YS Group's gross margin remained relatively stable for the fiscal years ended March 31, 2022 and 2023.

Selling and marketing expenses

Selling and marketing expenses increased by 46.7% from RMB186.0 million for the fiscal year ended March 31, 2022 to RMB272.9 million (\$39.7 million) for the fiscal year ended March 31, 2023. The increase in selling and marketing expenses was primarily due to (1) an increase of RMB1.1 million in employee benefits, and (2) an increase of RMB86.9 million in promoting and marketing service fees in order to expand the access to district and county CDCs and hospitals.

The following table sets forth a breakdown of YS Group's selling and marketing expenses in absolute amount and as a percentage of the total selling and marketing expenses for the periods indicated.

	Fiscal Year Ended March 31					
	2022		2023		Variance	
	RMB	%	RMB	%	RMB	%
Promoting and marketing service fees	162,461,330	87.3	249,347,280	91.4	86,885,950	53.5
Employee benefits	20,283,326	10.9	21,369,530	7.8	1,086,204	5.4
Other	3,255,048	1.8	2,210,546	0.8	(1,044,502)	(32.1)
Total	185,999,704	100.0	272,927,356	100.0	86,927,652	46.7

General and administrative expenses

General and administrative expenses decreased by 24.2% from RMB107.6 million for the fiscal year ended March 31, 2022 to RMB81.6 million (\$11.9 million) for the fiscal year ended March 31, 2023, primarily because (1) the professional service fee decreased significantly by RMB29.4 million, of which RMB32.8 million offering cost was capitalized; and (2) allowance for obsolete inventories decreased by RMB4.7 million, partially offset by an increase of RMB3.6 million in provision for trade receivables.

YS Group's bad debt expenses was RMB10.8 million for the fiscal year ended March 31, 2023, representing an increase of RMB5.7 million or 111.4%, from RMB5.1 million for 2022. Bad debt expenses are determined based on individual account analysis, historical collection trend, and best estimate of specific losses on individual exposures. YS Group deemed accounts receivables and other receivables as uncollectible after all means of collection have been exhausted and the likelihood of collection is not probable.

From April 1, 2023 to July 26, 2023, being the date of the auditors' opinion on YS Group's financial statement for the three fiscal years ended March 31, 2023, the subsequent settlement of YS Group's accounts receivable as of March 31, 2023 is shown in the following table:

Fiscal Year Ended March 31, 2023	0 – 90 days	90 – 180 days	180 – 365 days	>365 days	Total
2023(RMB)	25,828,981	60,212,761	78,120,813	16,717,979	180,880,534
2023(USD)	3,758,747	8,762,426	11,368,484	2,432,874	26,322,531

As of July 26, 2023, YS Group has collected approximately RMB181 million or 37% of its accounts receivable as of March 31, 2023. YS Group is not aware of any collection risk on the remaining balance.

YS Group's trading terms with its customers are mainly on a 120-days credit term. In practice, the credit term is normally 180 to 360 days.

The days sales outstanding increased by 25 days, or 10.7%, from 234 days for the fiscal year ended March 31, 2022 to 259 days for the fiscal year ended March 31, 2023. The increase in days sales outstanding was primarily due to the impact of COVID-19.

[Table of Contents](#)

The following table sets forth a breakdown of YS Group's general and administrative expenses in absolute amount and as a percentage of the total general and administrative expense for the periods indicated.

Fiscal Year Ended March 31						
	2022		2023		Variance	
	RMB	%	RMB	%	RMB	%
Employee benefits	41,599,522	38.7	41,381,933	50.7	(217,589)	(0.5)
Depreciation and Amortization	5,998,308	5.6	6,331,847	7.8	333,539	5.6
Professional service fees	30,680,853	28.5	1,272,893	1.6	(29,407,960)	(95.9)
Office	2,766,021	2.6	2,039,932	2.5	(726,089)	(26.3)
Provision for trade receivables	5,082,725	4.7	8,655,487	10.6	3,572,762	70.3
Provision for obsolete inventories	4,393,629	4.1	(323,492)	(0.4)	(4,717,121)	(107.4)
Taxes and surcharges	5,379,934	5.0	6,537,346	8.0	1,157,412	21.5
Other	11,719,508	10.8	15,699,331	19.2	3,979,823	34.0
Total	107,620,500	100.0	81,595,277	100.0	(26,025,223)	(24.2)

Research and development expenses

Research and development expenses decreased by 50.9%, from RMB211.2 million for the fiscal year ended March 31, 2022 to RMB318.7 million (\$46.4 million) for the fiscal year ended March 31, 2023. The increase in research and development expenses was primarily attributable to (i) an increase of RMB11.6 million in employee benefits driven by significant growth in YS Group's R&D headcount to support the growth and development of the pipeline; (ii) an increase of RMB141.3 million in testing and clinical trial fees associated with COVID-19 vaccines and rabies vaccines; and (iii) an increase of RMB4.9 million in depreciation and amortization for property, plant and equipment and intangible assets used for R&D purpose, partially offset by a decrease of RMB50.2 million in consulting service fees relating to the research of COVID-19.

The following table sets forth a breakdown of YS Group's research and development expenses in absolute amount and as a percentage of the total research and development expenses for the periods indicated.

Fiscal Year Ended March 31,						
	2022		2023		Variance	
	RMB	%	RMB	%	RMB	%
Testing and clinical trial fees	74,166,285	35.1	215,474,939	67.6	141,308,654	190.5
Consulting service fees	59,975,917	28.4	9,772,154	3.1	(50,203,763)	(83.7)
Employee benefits	56,513,100	26.8	68,073,077	21.4	11,559,977	20.5
Depreciation and amortization	10,796,480	5.1	15,736,087	4.9	4,939,607	45.8
Office and leasing	1,039,327	0.5	1,109,292	0.3	69,965	6.7
Other	8,731,154	4.1	8,534,977	2.7	(196,177)	(2.2)
Total	211,222,263	100.0	318,700,526	100.0	107,478,263	50.9

The following table below sets forth a breakdown of YS Group's key R&D projects.

Fiscal Year Ended March 31,						
	2022		2023		Variance	
	RMB	%	RMB	%	RMB	%
PIKA Recombinant COVID-19 vaccine	127,773,439	60.5	212,197,698	66.6	84,424,259	66.1
PIKA rabies vaccine	24,272,368	11.5	60,017,584	18.8	35,745,216	147.3
PIKA YS-ON-001	16,528,066	7.8	9,201,004	2.9	(7,327,062)	(44.3)
PIKA HBV vaccines	16,438,478	7.8	12,794,983	4.0	(3,643,495)	(22.2)
PIKA adjuvant	8,171,893	3.9	7,979,196	2.5	(192,697)	(2.4)
YSJA™ rabies vaccine	7,579,877	3.6	5,949,199	1.9	(1,630,678)	(21.5)
Other	10,458,142	4.9	10,560,862	3.3	102,720	1.0
Total	211,222,263	100.0	318,700,526	100.0	107,478,263	50.9

Other income (expenses)

YS Group recorded other expenses, net of RMB5.0 million (\$0.7 million) for the fiscal year ended March 31, 2023, as compared to other income, net of RMB17.9 million for the fiscal year ended March 31, 2022, primarily attributable to (1) a decrease of RMB1.3 million in late fee charge of social insurance and tax; (2) an increase of RMB3.1 million in government grants; and (3) an increase of RMB28.1 million in financial expense which was primarily attributable to (i) an increase of RMB28.7 million in interest expense on bank loans and royalty fee under the Facility Agreement; (ii) an increase of RMB0.5 million interest expense on other loans.

Income tax expense

YS Biopharma's PRC subsidiaries are subject to income taxes in China on their taxable income calculated at a tax rate in accordance with the relevant income tax laws and regulations. YS Group determine deferred taxes for each tax-paying entity in each tax jurisdiction. The potential tax benefits arising from the losses incurred by the subsidiaries have been recorded in its financial statements. YS Group's income tax expense decreased from RMB4.9 million in the fiscal year ended March 31, 2022 to RMB1.1 million (\$0.2 million) in the fiscal year ended March 31, 2023, primarily due to the decrease in deferred tax assets from disposing of inventories that have been impaired in the previous period.

YS Group evaluates its valuation allowances requirements at each reporting period by reviewing all available evidence, both positive and negative, and considering whether, based on the weight of that evidence, a valuation allowance is needed. When a change in circumstances causes a change in management's judgment about the ability to realize deferred tax assets, the impact of the change on the valuation allowance is generally reflected in income from operations. The future realization of the tax benefit of an existing deductible temporary difference ultimately depends on the existence of sufficient taxable income of the appropriate character within the carry forward period available under applicable tax law.

Net loss

As a result of the foregoing, YS Group recognized net loss of RMB191.8 million, RMB106.0 million and RMB145.5 million (\$21.2 million) for the fiscal year ended March 31, 2021, 2022 and 2023, respectively.

Fiscal year ended March 31, 2022 compared to fiscal year ended March 31, 2021.

Revenue

YS Group's revenue increased by 95.7% from RMB257.0 million for the fiscal year ended March 31, 2021 to RMB502.9 million for the fiscal year ended March 31, 2022, primarily because (1) the sales period was approximately six months in 2021 fiscal year, as YS Group started selling the YSJA™ rabies vaccine products in October 2020; and (2) the product price increased by approximately RMB2 per dose in the 2022 fiscal year.

Cost of revenue

YS Group's cost of revenue primarily consisted of raw material costs, staff costs, manufacturing costs and depreciation expenses. The cost increased by 96.2% from RMB59.7 million for the fiscal year ended March 31, 2021 to RMB117.1 million for the fiscal year ended March 31, 2022. The increase in costs was attributable primarily to the increase in sales volume of YSJA™ rabies vaccine products.

Gross profit and gross margin

YS Group's gross profit increased by 95.5% from RMB197.4 million for the fiscal year ended March 31, 2021 to RMB385.9 million for the fiscal year ended March 31, 2022. The increase in gross profit was primarily due to the increase in revenue. YS Group's gross margin was stable for the fiscal years ended March 31, 2022 and 2021.

Selling and marketing expenses

Selling and marketing expenses increased significantly from RMB73.5 million for the fiscal year ended March 31, 2021 to RMB186.0 million for the fiscal year ended March 31, 2022. The increase in selling and marketing expenses was primarily due to an increase of RMB97.7 million in promoting and marketing service fees related to the commercialization of YSJA™ rabies vaccine and an increase of RMB16.2 million in employee benefits.

The following table sets forth a breakdown of YS Group's selling and marketing expenses in absolute amount and as a percentage of the total selling and marketing expenses for the periods indicated.

	Fiscal Year Ended March 31,					
	2021		2022		Variance	
	RMB	%	RMB	%	RMB	%
Promoting and marketing service fees	64,770,329	88.1	162,461,330	87.3	97,691,001	150.8
Employee benefits expenses	4,049,357	5.5	20,283,326	10.9	16,233,969	400.9
Others	4,665,573	6.4	3,255,048	1.8	(1,410,525)	(30.2)
Total	73,485,259	100.0	185,999,704	100.0	112,514,445	153.1

General and administrative expenses

General and administrative expenses decreased by 30.7% from RMB155.3 million for the fiscal year ended March 31, 2021 to RMB107.6 million for the fiscal year ended March 31, 2022, primarily due to a decrease of RMB64.4 million in share-based compensation expenses, as most of YS Group's options had been vested before March 31, 2021, which was partially offset by an increase of RMB16.1 million in staff cost.

YS Group's bad debt expenses was RMB5.1 million for the fiscal year ended March 31, 2022, representing a decrease of RMB1.9 million or 27.4%, from RMB7.0 million for the fiscal year of 2021. Bad debt expenses are determined based on individual account analysis, historical collection trend, and best estimate of specific losses on individual exposures. YS Group deemed accounts receivables and other receivables as uncollectible after all means of collection have been exhausted and the likelihood of collection is not probable.

From April 1, 2022 to September 27, 2022, being the date of the auditors' opinion on YS Group's financial statement for the two fiscal years ended March 31, 2022, the subsequent settlement of YS Group's accounts receivable as of March 31, 2022 is shown in the following table:

Fiscal Year Ended March 31,	0 – 90 days	90 – 180 days	180 – 365 days	>365 days	Total
2022 (RMB)	73,593,680	64,397,895	58,064,055	7,184,920	203,240,550
2022 (USD)	\$ 11,592,842	\$ 10,144,276	\$ 9,146,538	\$ 1,131,804	\$ 32,015,460

As of September 27, 2022, YS Group had collected approximately RMB203 million, or 63%, of its accounts receivable as of March 31, 2022. YS Group is not aware of any collection risk on the remaining balance.

YS Group's trading terms with its customers are mainly on a 120-days credit term. In practice, the credit term is normally 180 to 360 days.

The days sales outstanding decreased by 83 days, or 26.2%, from 317 days for the fiscal year ended March 31, 2021 to 234 days for the fiscal year ended March 31, 2022. The decrease in days sales outstanding was primarily due to the fact that the sales period is approximately six months in 2021 fiscal year as YS Group started selling the YSJA rabies vaccine products since October 2020.

[Table of Contents](#)

The following table sets forth a breakdown of YS Group's general and administrative expenses in absolute amount and as a percentage of the total general and administrative expense for the periods indicated.

Fiscal Year Ended March 31,						
	2021		2022		Variance	
	RMB	%	RMB	%	RMB	%
Employee benefits	89,872,239	57.9	41,599,522	38.7	(48,272,717)	(53.7)
Depreciation and Amortization	9,489,983	6.1	5,998,308	5.6	(3,491,675)	(36.8)
Professional service fees	33,649,233	21.7	30,680,853	28.5	(2,968,380)	(8.8)
Office expenses	4,020,338	2.6	2,766,021	2.6	(1,254,317)	(31.2)
Provision for trade receivables	6,998,818	4.5	5,082,725	4.7	(1,916,093)	(27.4)
Provision for obsolete inventories	—	—	4,393,629	4.1	4,393,629	100.0
Taxes and surcharges	4,004,265	2.6	5,379,934	5.0	1,375,669	34.4
Other	7,299,510	4.6	11,719,508	10.8	4,419,998	60.4
Total	155,334,386	100.0	107,620,500	100.0	(47,713,886)	(30.7)

Research and development expenses

Research and development expenses increased significantly from RMB94.4 million for the fiscal year ended March 31, 2021 to RMB211.2 million for the fiscal year ended March 31, 2022. The increase in research and development expenses was primarily attributable to (i) an increase of RMB27.3 million in employee benefits driven by significant growth in YS Group's research and development headcount to support the growth and development of the pipeline; (ii) an increase of RMB53.7 million in testing and clinical trial fees associated with COVID-19 vaccines, rabies vaccines and anticancer vaccines; (iii) an increase of RMB28.5 million in consulting service fees relating to the research of COVID-19; and (iv) an increase of RMB4.5 million in depreciation and amortization for property, plant and equipment and intangible assets used for research and development purpose.

The following table sets forth a breakdown of YS Group's research and development expenses in absolute amount and as a percentage of the total research and development expenses for the periods indicated.

Fiscal Year Ended March 31,						
	2021		2022		Variance	
	RMB	%	RMB	%	RMB	%
Testing and clinical trial fees	20,480,320	21.7	74,166,285	35.1	53,685,965	262.1
Consulting service fees	31,492,876	33.4	59,975,917	28.4	28,483,041	90.4
Employee benefits	29,178,337	30.9	56,513,100	26.8	27,334,763	93.7
Depreciation and amortization	6,331,638	6.7	10,796,480	5.1	4,464,842	70.5
Office and leasing	3,446,146	3.7	1,039,327	0.5	(2,406,819)	(69.8)
Others	3,457,827	3.6	8,731,154	4.1	5,273,327	152.5
Total	94,387,144	100.0	211,222,263	100.0	116,835,119	123.8

The following table below sets forth a breakdown of YS Group's key R&D projects.

Fiscal Year Ended March 31,						
	2021		2022		Variance	
	RMB	%	RMB	%	RMB	%
PIKA Recombinant COVID-19 vaccine	33,903,400	35.9	127,773,439	60.5	93,870,039	276.9
PIKA rabies vaccine	13,718,774	14.5	24,272,368	11.5	10,553,594	76.9
PIKA YS-ON-001	4,312,590	4.6	16,528,066	7.8	12,215,476	283.3
PIKA HBV vaccines	7,536,556	8.0	16,438,478	7.8	8,901,922	118.1
PIKA adjuvant	26,036,582	27.6	8,171,893	3.9	(17,864,689)	(68.6)
YSJA™ rabies vaccine	3,939,781	4.2	7,579,877	3.6	3,640,096	92.4
Others	4,939,461	5.2	10,458,142	4.9	5,518,681	111.7
Total	94,387,144	100.0	211,222,263	100.0	116,835,119	123.8

Other income (expenses)

YS Group recorded other income, net of RMB17.9 million for the fiscal year ended March 31, 2022, as compared to other expenses, net of RMB48.5 million for the fiscal year ended March 31, 2021, primarily attributable to (1) a decrease of RMB24.34 million in late fee charge of social insurance and tax; and (2) an increase of RMB19.5 million in government grants, which was partially offset by a decrease of RMB4.4 million in other income; (3) an decrease of RMB5.0 million in financial expense which was primarily attributable to (i) a decrease of RMB3.0 million in interest expense on bank loans, as interest rate on bank loans decreased from 8% and 8.0475% per annum in the fiscal year ended March 31, 2022 to 5.3% and 5.655% in the fiscal year ended March 31, 2022 and repayment by YS Group of RMB49.6 million in bank loan in the fiscal year ended March 31, 2022; (ii) a decrease of RMB2.0 million in interest expense on borrowings from YS Group's employees; and (iii) a decrease of RMB22.0 million in the transaction cost for issuance of convertible notes and preferred shares in the fiscal year ended March 31, 2021.

Income tax expense

YS Group's PRC subsidiaries are subject to income taxes in China on their taxable income calculated at a tax rate in accordance with the relevant income tax laws and regulations. YS Group determines deferred taxes for each tax-paying entity in each tax jurisdiction. The potential tax benefits arising from the losses incurred by the subsidiaries have been recorded in YS Group's financial statements. YS Group's income tax expense decreased from RMB17.5 million in the fiscal year ended March 31, 2021 to RMB4.9 million in the fiscal year ended March 31, 2022, primarily due to the decrease in deferred tax assets from disposing of inventories that have been impaired in the previous period.

YS Group evaluates its valuation allowances requirements at each reporting period by reviewing all available evidence, both positive and negative, and considering whether, based on the weight of that evidence, a valuation allowance is needed. When a change in circumstances causes a change in management's judgment about the ability to realize deferred tax assets, the impact of the change on the valuation allowance is generally reflected in income from operations. The future realization of the tax benefit of an existing deductible temporary difference ultimately depends on the existence of sufficient taxable income of the appropriate character within the carry forward period available under applicable tax law.

Net loss

As a result of the foregoing, YS Group recognized net loss of RMB106.0 million and RMB191.8 million for the fiscal year ended March 31, 2022 and 2021, respectively.

Liquidity and Capital Resources

The following table sets forth a summary of YS Group's cash flows for the periods indicated.

	Fiscal Year Ended March 31,			
	2021	2022	2023	
	RMB	RMB	RMB	US\$
Net cash used in operating activities	(246,610,437)	(173,545,357)	(182,469,396)	(26,553,749)
Net cash used in investing activities	(104,238,941)	(298,923,958)	(56,981,720)	(8,292,230)
Net cash provided by financing activities	739,258,696	364,558,145	317,449,926	46,196,709
Effect of foreign exchange rate on cash and cash equivalents	(2,674)	(11,478,411)	21,303,512	3,100,180
Net increase (decrease) in cash and cash equivalents	388,406,644	(119,389,581)	99,302,322	14,450,910
Cash and restricted cash at the beginning of the fiscal year	2,050,440	390,457,084	271,067,503	39,446,935
Cash and restricted cash at the end of the fiscal year	390,457,084	271,067,503	370,369,825	53,897,845

[Table of Contents](#)

	Six Months Ended September 30,		
	2022	2023	2023
	(RMB)	(RMB)	(US\$)
	(Unaudited)	(Unaudited)	(Unaudited)
Net cash used in operating activities	(107,395,153)	(145,831,735)	(20,311,391)
Net cash used in investing activities	(19,024,351)	(23,421,694)	(3,262,165)
Net cash provided by financing activities	51,907,325	44,855,849	6,247,507
Effect of foreign exchange rate on cash and cash equivalents	30,471,942	13,933,287	1,940,621
Net decrease in cash and cash equivalents	(44,040,237)	(110,464,293)	(15,385,428)
Cash and restricted cash at the beginning of the period	271,067,503	370,369,825	51,584,978
Cash and restricted cash at the end of the period	227,027,266	259,905,532	36,199,550

YS Group has historically financed its operations primarily through issuance of ordinary and preferred shares, issuance of convertible securities and cash generated from sales of its vaccines. YS Group's primary requirements for liquidity and capital are to finance working capital, capital expenditures and general corporate purposes as well as investment in R&D and potential mergers and acquisition opportunities.

As of March 31, 2021, 2022 and 2023, YS Group's principal source of liquidity was its cash balance of RMB271.1 million and RMB390.5 million, RMB271.1 million and RMB370.4 million (\$53.9 million), respectively, which was held for working capital purposes. As of September 30, 2022 and 2023, YS Group's principal source of liquidity was its cash balance of RMB227.0 million and RMB 259.9 million (\$36.2 million). YS Group incurred a net loss after tax of RMB191.8 million, RMB106.0 million and RMB145.5 million (\$21.2 million) for the fiscal year ended March 31, 2021, 2022 and 2023, respectively. YS Group incurred a net loss after tax of RMB11.1 million and RMB174.5 million (\$24.3 million) for the six months ended September 30, 2022 and 2023, respectively.

YS Group's primary uses of cash are to fund the development of its product candidates, its clinical trials, its construction of research and manufacturing facilities, purchase of equipment, compensation of key personnel, administrative expenses and other recurring expenses. YS Group's net cash used in operating activities was RMB173.5 million and RMB182.5 million (\$26.6 million) in the fiscal year ended March 31, 2022 and 2023, respectively, primarily due to the significant research and development expenses and administrative expenses. YS Group's net cash used in operating activities was RMB107.4 million and RMB145.8 million (\$20.3 million) for the six months ended September 30, 2022 and 2023, respectively, primarily due to the significant R&D expenses, selling expenses and administrative expenses. YS Group's operating cash flow will continue to be affected by its R&D expenses, in particular clinical trial fees for its product candidates. YS Group has historically primarily funded its working capital requirements through issuance of ordinary and preferred shares, issuance of convertible securities and cash generated from sales of our vaccines. And our proceeds from the Business Combination are mainly used for overseas clinical trial and operations, while proceeds from bank loans is mainly used for operations of PRC subsidiaries.

YS Group plans to use the outstanding cash, together with bank borrowings and cash from operating activities, to fund YS Group's future operations. YS Group uses proceeds from the Business Combination for overseas clinical trials and operations, and proceeds from bank loans for the operations of PRC subsidiaries. However, if the commercialization of its marketed product and product candidates is delayed or terminated, or if expenses increase, YS Group may need to obtain additional financing to fund its operations.

YS Group's ability to obtain additional financing from the exercise of Warrants may be limited. There is no assurance the holders of the Warrants will exercise any of the Warrants, which could impact YS Group's liquidity position. Whether holders of Warrants will exercise their Warrants, and therefore the amount of cash proceeds YS Group would receive upon exercise, is dependent upon the trading price of the Ordinary Shares. Each Warrant will become exercisable for one Ordinary Share at \$11.50. Therefore, if and when the trading price of the Ordinary Shares is less than \$11.50, YS Group expects that holders of Warrants would not have the financial incentive to exercise their Warrants. YS Group could receive up to approximately \$192.6 million if all of the Warrants are exercised for cash, but YS Group would only receive such proceeds if and when the holders of Warrants exercise the Warrants. The Warrants may not be or remain in the money during the period they are exercisable and prior to their expiration and, therefore, it is possible that the Warrants may not be exercised prior to their maturity on March 15, 2028, even if they are in the money, and as such, may expire worthless with minimal proceeds received by YS Group, if any, from the exercise of Warrants. To the extent that any of the Warrants are exercised on a "cashless basis," YS Group will not receive any proceeds upon

such exercise. As a result of the above and coupled with the level of Redemption Rate, YS Group does not expect to rely on the cash exercise of Warrants to fund its operations. Instead, YS Group intends to rely on other sources of cash to continue to fund its operations.

YS Group's management monitors uses of cash and cash balances and strives to maintain a healthy liquidity for its operations. Going forward, YS Group believes its liquidity requirements will be satisfied by cash generated from its operations and financing activities. As of September 30, 2023 and March 31, 2023, YS Group's working capital was RMB271.5 million (\$37.8 million) and RMB377.2 million, respectively.

Operating activities

Cash flows from operating activities represent the cash receipts and disbursements related to YS Group's all activities other than investing and financing activities. Operating cash flow is derived by adjusting YS Group's net loss for non-cash operating items such as depreciation, and stock-based compensation, as well as changes in operating assets and liabilities, which reflect timing differences between the receipt and payment of cash associated with transactions and when they are recognized in YS Group's results of operations.

Net cash used in operating activities of RMB145.8 million (\$20.3 million) for the six months ended September 30, 2023 was primarily from a net loss of RMB174.5 million (\$24.3 million) adjusted for certain non-cash items, which included deferred income taxes RMB0.8 million (\$0.1 million), depreciation of RMB16.5 million (\$2.3 million), amortization of intangible assets of RMB3.4 million (\$0.4 million), impairment of accounts receivable of RMB5.3 million (\$0.7 million), write-down of inventories to net realizable value of RMB10.7 million (\$1.5 million), non-cash lease expense of RMB2.5 million (\$0.3 million), and increase of fair value change of warrant liabilities of RMB6.9 million (\$1.0 million). The net changes in operating assets and liabilities of RMB2.0 million (\$0.3 million) were primarily from an increase in inventories of RMB38.1 million (\$5.3 million) due to decrease in batch approvals affected by COVID-19 in early 2023, a decrease in trade receivables of RMB28.3 million (\$3.9 million) due to decrease in sales volume resulting from batch approvals and doses available for sale drawdown affected by COVID-19, an increase in prepaid expenses and other current assets of RMB22.4 million (\$3.1 million) due primarily to prepayment for R&D and patent, an increase in trade payables of RMB4.5 million (\$0.6 million) as a result of raw materials purchase, an increase in accrued expenses and current liabilities of RMB29.3 million (\$4.1 million) due to increase in promotion fee to promote the YSJA™ rabies vaccine products continuously, a decrease in deferred government grant of RMB1.1 million (\$0.2 million) and a decrease in payment of lease liabilities of RMB2.5 million (\$0.4 million).

Net cash used in operating activities of RMB182.5 million (\$26.6 million) for the fiscal year ended March 31, 2023 was primarily related to a net loss for the fiscal year of RMB145.5 million (\$21.2 million) adjusted for certain non-cash items, which included deferred income taxes RMB1.1 million (\$0.2 million), depreciation of property, plant and equipment of RMB29.7 million (\$4.3 million), amortization of intangible assets of RMB7.0 million (\$1.0 million), share-based compensation expense of RMB3.5 million (\$0.5 million), bad debt provision of trade receivable and inventories of RMB10.8 million (\$1.6 million), reversal of inventories to net realizable value of RMB0.7 million (\$0.1 million), non-cash lease expense of RMB4.4 million (\$0.6 million), and increase of fair value change of warrant liabilities of RMB0.02 million (\$0.003 million). The net changes in operating assets and liabilities of RMB92.7 million were primarily related to an increase in inventories of RMB18.2 million due to increase in production batches, an increase in trade receivables of RMB165.2 million from increased sales of the rabies vaccine in 2023 fiscal year, a decrease in prepaid expenses and other current assets of RMB9.0 million primarily due to increased prepayments for construction in progress, an increase in trade payables of RMB49.6 million as a result of extending the accounting period for customers, an increase in accrued expenses and current liabilities of RMB43.0 million due to RMB22.7 million of promotion fee to expand the access to district and county CDCs and hospitals and RMB29.3 million of marketing deposit and transportation fees resulting from expanded sales, which were partially offset by decrease in deferred government grant of RMB6.4 million, and payment of lease liabilities of RMB4.6 million.

Net cash used in operating activities of RMB173.5 million for the fiscal year ended March 31, 2022 was primarily related to a net loss for the fiscal year of RMB106 million adjusted for certain non-cash items, which included Deferred income taxes RMB4.9 million, depreciation of property, plant and equipment of RMB24.5 million, amortization of intangible assets of RMB6.7 million, loss on disposal of property, plant and equipment of RMB0.3 million, share-based compensation expense of RMB7.8 million, impairment of trade receivable and inventories of RMB5.1 million, write-down of inventories to net realizable value of RMB4.4 million, and non-cash lease expense of RMB3.8 million. The net changes in operating assets and liabilities of RMB124.9 million were primarily related to an increase in inventories

[Table of Contents](#)

of RMB89.5 million due to increased demand in rabies vaccine and YS Group's decision to continue to increase its inventory level to avoid any unpredictable logistics disruption or rising cost of raw material from the ongoing impact of COVID-19 on the global supply chain, an increase in trade receivables of RMB99.1 million from increased sales of the rabies vaccine in 2022 fiscal year, a decrease in amounts due from related parties of RMB30.1 million, a decrease in prepaid expenses and other current assets of RMB59.2 million primarily due to increased prepayments for construction in progress, an increase in trade payables of RMB14.4 million as a result of extending the accounting period for customers, which were partially offset by a decrease in accrued expenses and current liabilities of RMB35.6 million due to decrease expenditure on staff costs and increase expenditure for construction in progress, decrease in deferred government grant of RMB0.7 million, and payment of lease liabilities of RMB3.8 million.

Net cash used in operating activities of RMB246.6 million for the fiscal year ended March 31, 2021 was primarily related to a loss before tax for the year of RMB191.8 million, adjusted for certain non-cash items, which included deferred income tax of RMB17.5 million, depreciation of property, plant and equipment of RMB22.2 million, amortization of intangible assets of RMB5.7 million, share-based compensation expense of RMB76.8 million, impairment of trade receivable of RMB6.4 million, write-down of inventories to net realizable value RMB1.1 million, and non-cash lease liability of RMB2.2 million. The net changes in operating assets and liabilities of RMB186.7 million were primarily related to an increase in inventories of RMB68.7 million due to increased demand in rabies vaccine and YS Group's decision to continue to increase its inventory level to avoid any unpredictable logistics disruption or rising cost of raw material from the ongoing impact of COVID-19 on the global supply chain, an increase in trade receivables of RMB220.7 million from increased sales of the rabies vaccine in 2021 fiscal year, an increase in amounts due from related parties of RMB3.1 million, an increase in prepaid expenses and other current assets of RMB146.8 million primarily due to increase in advance to suppliers, a decrease in trade payables of RMB4.4 million, payment of income tax for previous years of RMB34.1 million, and payment of lease liabilities of RMB2.2 million.

Investing activities

Cash flows used in investing activities were primarily for purchase of property, plant and equipment, acquisition of a subsidiary (net of cash acquired), investment in joint ventures as well as purchase of intangible assets.

Net cash used in investing activities was RMB23.4 million (\$3.3 million) for the six months ended September 30, 2023, which consisted primarily of payment for purchase of items of property, plant and equipment of RMB23.6 million (\$3.3 million), partially offset by a cash inflow from proceeds from disposal of property, plant and equipment of RMB0.2 million (\$0.02 million)

Net cash used in investing activities was RMB57.0 million (\$8.3 million) for the fiscal year ended March 31, 2023 which consisted primarily of payment for purchase of items of property, plant and equipment of RMB52.8 million (\$7.7 million) and partial payment for purchase of intangible assets of RMB4.3 million (\$0.6 million).

Net cash used in investing activities was RMB298.9 million for the fiscal year ended March 31, 2022, which consisted primarily of payment for purchase of items of property, plant and equipment of RMB295.3 million and partial payment for purchase of intangible assets of RMB3.6 million.

Net cash used in investing activities was RMB104.2 million for the fiscal year ended March 31, 2021, which consisted primarily of payment for purchase of items of property, plant and equipment of RMB104.9 million, partially offset by a cash inflow from proceeds from disposal of property, plant and equipment of RMB0.6 million.

Financing activities

Net cash generated from financing activities was RMB44.9 million (\$6.2 million) for the six months ended September 30, 2023, which consisted primarily of RMB 201.2million (\$28.0 million) in proceeds from bank and other borrowings, partially offset by RMB156.4million (\$21.8 million) in repayment of bank.

Net cash generated from financing activities was RMB317.4 million (\$46.2 million) for the fiscal year ended March 31, 2023, which consisted primarily of RMB252.5 million (\$36.7 million) in the Business Combination, partially offset by RMB35.9 (\$5.2 million) in offering cost, and RMB247.4 million (\$36.0 million) in proceeds from bank and other borrowings, partially offset by RMB146.5 million (\$21.3 million) in repayment of bank.

[Table of Contents](#)

Net cash generated from financing activities was RMB364.6 million for the fiscal year ended March 31, 2022, which consisted primarily of RMB414.1 million in proceeds from bank and other borrowings, partially offset by RMB49.6 million in repayment of bank.

Net cash generated from financing activities was RMB739.3 million for the fiscal year ended March 31, 2021, which consisted primarily of RMB729.4 million in proceeds from issuance of mezzanine equity, RMB32.3 million in proceeds from bank and other borrowings, and RMB299.8 million in proceeds of loans from related parties, partially offset by RMB160.4 million in repayment of bank and other borrowings, RMB163.3 million in repayment of related parties, and RMB1.6 million in shareholders' contributions.

Contractual Obligations

On September 13, 2021, YS Group entered into a credit facility of RMB100 million with China Guangfa Bank Co., Ltd. Shenyang Branch for three years to finance its working capital requirements. YS Group drew RMB45.4 million from January 13, 2023 to August 24, 2023 with interest at 5.66%, which is due from December 16, 2023 to March 12, 2024. As of date of this report, YS Group repaid RMB45.4 million.

On July 12, 2021, YS Group entered into a credit facility of RMB140 million with Shanghai Pudong Development Bank Co., Ltd. Shenyang Branch for three years to finance its working capital requirements. YS Group drew down RMB83.0 million from June 30, 2022 to December 13, 2022 with interest at 5.30%, which was due from June 29, 2023 to December 12, 2023. In April, July and September, 2023, YS Group repaid RMB20.9 million, RMB32.4 million and RMB29.7 million, respectively.

On March 16, 2022, YS Group entered into a facility agreement with ReBridge Healthcare Fund, LP, as agent, to finance RMB287,192,000 (US\$40,000,000) for 54 months with interest at 4.00%. YS Group shall repay the loan in instalments on each Repayment Date which means the fifth business day after each financial quarter date in an amount equal to the relevant percentage of the aggregate outstanding principal amount of the loan as at the end of the Availability Period as set out in the table below:

Repayment Date	Repayment Instalment
April 7, 2025	6,400,000
July 7, 2025	6,400,000
October 7, 2025	6,400,000
January 7, 2026	6,400,000
April 7, 2026	6,400,000
July 7, 2026	8,000,000
Total	40,000,000

Under the terms of the Facility Agreement, YS Group shall ensure:

- (a) at any time on or prior to the date falling 12 months after the utilization date:
 - (i) the net sales of the included products in respect of each period of 12 months ending on the last day of each financial year and each period of 12 months ending on the last day of each financial quarter ("Relevant Period") shall not be less than RMB400,000,000; and
 - (ii) the total debt to net sales of the included products in respect of any Relevant Period shall not be more than 1.25:1;
- (b) at any time after the date falling 12 months after the utilization date:
 - (i) the net sales of the included products in respect of any annual Relevant Period shall not be less than RMB500,000,000; and
 - (ii) the total debt to net sales of the included products in respect of any Relevant Period shall not be more than 1:1;

[Table of Contents](#)

- (c) the EBITDA margin in respect of any Relevant Period shall not be less than 25%; and
- (d) at any time after the date falling 18 Months after the utilization date, the EBITDA margin in respect of any Relevant Period shall not be less than 20%.

If there is (or it is anticipated that there will be) a breach, YS Group may apply for a waiver of such breach or requirement by the majority lenders. Such breach shall cease to constitute an event of default if the majority lenders have agreed to grant such waiver. If not, YS Group shall prepay the loan in whole or in part.

YS Group shall ensure that no other group member will acquire any company, shares, securities, business, assets, or undertaking or make any investment except for that an acquisition the total consideration for which (when aggregated with (A) the total consideration for any other acquisition made in the same financial year, and (B) the aggregate amount of investments in any joint venture made in the same financial year) does not exceed RMB30,000,000 (or its equivalent in another currency or currencies)

On December 27, 2023, YS Group received a letter from R-Bridge (the "R-Bridge Letter"), notifying YS Group they have reason to believe YS Group has defaulted under financial covenants and other obligations under the facility agreement, and under the instructions of the lenders to urge YS Group to consider and reach an amicable solution with the lenders, including, without limitation, repaying the Loan in full, as soon as possible. In response to the R-Bridge Letter, YS Group has provided the financial information to R-Bridge at its request and is currently working with the lenders under the facility agreement to negotiate a resolution. If lenders under the facility agreement are not satisfied and insist YS Group has defaulted under the facility agreement, such lenders may declare all or part of the loan, the accrued interest, and all other amounts accrued or outstanding be immediately due and payable. If such lenders demand the prepayment of the loan in its full amount of \$40 million, YS Group may be forced to seek additional funding to meet its obligation under the facility agreement, otherwise it may not be able to continue as a going concern.

Under the terms of the Facility Agreement, YS Group and Agent also entered into a Deed, pursuant to which YS Group will pay to Agent, the Royalties on the Products as contingent interest in addition to the payments made to Agent under the Facility Agreement, on the terms and subject to the conditions of the Deed. YS Group is obliged to pay royalties to such agent as contingent interest for the facility based upon YS Group's annual net sales of rabies vaccines by multiplying the royalty rate ranging from 1.5% to 3.5% by the corresponding amount incremental net sales for that financial year.

YS Group shall pay accrued interest on the Loan on each Payment Date. As of September 30, 2023, YS Group accrued approximately RMB4.4 million (US\$0.6 million) of interest.

On January 13, 2023, YS Group entered into a credit facility of RMB40 million with China CITIC Bank Shenyang Tiexi Branch, due on November 29, 2023, to finance our working capital requirements. YS Group drew RMB36.4 million from January 18, 2023 to July 11, 2023 with interest at 5.00%, which is due from October 13, 2023 to May 29, 2024. As of date of this report, YS Group repaid RMB23.6million.

On May 6, 2022, China CITIC Bank Shenyang Tiexi Branch issued one letter of credit of RMB5.0 million to YS Group with interest at 3.25%. As of March 31, 2023, YS Group had RMB4.7 million in letters of credit issued, which is due from May 19, 2023 to July 17, 2023. From May to July 2023, YS Group repaid RMB4.7 million.

From July 17 to July 18, 2023, YS Group borrowed RMB3,550,600 with interest at 4.75% from China CITIC Bank Shenyang Tiexi Branch. The loan is due on May 29, 2024.

From November 22, 2022 to September 1, 2023, YS Group borrowed RMB33.2 million in total with interest at 4.00% from China Construction Bank Shenyang Heping Branch for one year. The loan will be due from November 21, 2023 to August 31, 2024. As of date of this report, YS Group repaid RMB8.9million.

On January 16, 2023, YS Group borrowed RMB988,000 with interest at 3.90% from China Construction Bank Shenyang Heping Branch for one year. In December 2023, YS Group repaid RMB988,000 in advance. On July 20, 2023, YS Group borrowed RMB712,400 with interest at 3.90% for one year. The loan will be due on July 19, 2024.

From March 17 to June 7 2023, YS Group borrowed RMB14.7 million with interest at 4.00% from China Construction Bank Shenyang Heping Branch for 18 months. The loan will be due from September 16, 2024 to December 6, 2024.

[Table of Contents](#)

On November 8, 2022, YS Group borrowed RMB26.0 million with interest at 5.00% from Zhongguancun Technology Leasing Co., Ltd for 36 months. YS Group shall repay RMB722,222 monthly from December 15, 2022 to October 15, 2025 and pay the last repayment of RMB722,230 on November 7, 2025. YS Group repaid RMB7.2 million from December 2022 to September 2023. The balance of RMB18.8 million is outstanding, of which RMB8.7 million is due within one year. As of date of this report, YS Group repaid RMB2.9million.

On May 29, 2023, YS Group borrowed RMB40.0 million with interest at 4.8% from CITIC Financial Leasing Co., Ltd due on May 29, 2026. On August 15, 2023, YS Group repaid RMB3.2 million. The balance of RMB36.8 million is outstanding, of which RMB12.8 million is due within one year. As of date of this report, YS Group repaid RMB3.2 million.

From July 7 to July 19, 2023, YS Group borrowed RMB11.3 million with interest at 4.00% from Minsheng Bank Shenyang Huanghe Street Branch for one year. The loan will be due from July 7 to July 19, 2024.

On August 14 and September 14, 2023, YS Group borrowed RMB4.0million and RMB16.0 million with interest at 4.25% from Industrial Bank Shenyang Branch for approximately three years. The loans will be due on July 31, 2026 and September 3, 2026.

From August 16 to September 18, 2023, YS Group borrowed RMB29.8 million with interest at 4.00% from Industrial Bank Shenyang Branch for one year. The loan will be due from August 15 to September 17, 2024.

On September 27, 2023, YS Group borrowed RMB6.0 million with interest at 4.00% from Shanghai Pudong Development Bank Co., Ltd. Shenyang Branch. The loans will be due from March 21, 2024 to September 26, 2025.

YS Group recorded RMB14.9 million and RMB15.2 million of interest expense for the six months ended September 30 2023 and 2022, respectively.

Lease liabilities

A summary of YS Group's operating lease commitments as of September 30, 2023 is as follows:

Year Ended September 30,	(RMB)	(US\$)
2024	5,332,992	\$ 742,777
2025	4,275,341	595,468
2026	357,806	49,835
Total lease payments	9,966,139	1,388,080
Less: Interest	475,985	66,295
Present value of operating lease liabilities	9,490,154	\$ 1,321,785

As of September 30, 2023, the outstanding, discounted amount of lease liabilities was RMB9.5 million (\$1.3 million) which was related to the lease agreements for one premises in China, one premises in Singapore, one premises in US and one premises in Philippines.

Contingencies

In 2018, Liaoning Yisheng filed a sales contract dispute with Hebei Defense Biological Products Supply Center. The Supreme People's Court of Liaoning supported the Liaoning Yisheng's claim that the defendant Hebei Weifang should pay RMB2,465,807 for Liaoning Yisheng vaccine within 20 days after the judgment came into effect. As of the date of this report, YS Group received RMB1,636,755 compensation from Hebei Defense Biological Products Supply Center, and the balance of RMB829,052 compensation may be received in fiscal 2024.

In 2023, Liaoning Yisheng was involved in a dispute with Shenyang Haoyu Landscape Engineering Co., Ltd ("Shenyang Haoyu") for the greening construction. In December, 2023, Shenyang Shenbei New District People's Court of Liaoning supported Shenyang Haoyu's claim that Liaoning Yisheng should pay RMB73,601. To the date, YS Group paid RMB73,601 to Shenyang Haoyu.

In March 2023, Beijing Yisheng filed a technology transfer contract dispute with Tianjin Hemu Jianmin Biotechnology Co., Ltd ("Tianjin Hemu Jianmin") to Tianjin Arbitration Commission. Beijing Yisheng claimed Tianjin Hemu Jianmin should refund RMB1.0 million and the contract should terminate. In December, 2023, Tianjin Arbitration Commission only supported Beijing Yisheng's claim of terminating the contract. Beijing Yisheng is considering

[Table of Contents](#)

applying for dismissal from Tianjin Second Intermediate People’s Court. As the proceedings are in the early stages, there is uncertainty regarding the timing or ultimate resolution of such matters, and therefore, an estimate for the reasonably possible gain or a range of reasonably possible gains cannot be made.

In October, 2023, Liaoning Yisheng filed an engineering dispute with Shenyang Baimu Technology Co., Ltd (“Shenyang Baimu”), claiming Shenyang Baimu should pay a penalty of RMB2,180,000 for engineering delays and refund the overpaid funds. As the proceedings are in the early stages, there is uncertainty regarding the timing or ultimate resolution of such matters, and therefore, an estimate for the reasonably possible gain or a range of reasonably possible gains cannot be made.

YS Group was also involved in labor disputes as of September 30, 2023. As the proceedings are in the early stages or the second appeal, there is considerable uncertainty regarding the timing or ultimate resolution of such matters, and therefore, an estimate for the reasonably possible loss or a range of reasonably possible losses cannot be made.

On December 27, 2023, HK Yisheng received a letter from R-Bridge (the “R-Bridge Letter”), notifying the Company that they have reason to believe that HK Yisheng has defaulted under financial covenants and other obligations under the facility agreement, and under the instructions of the lenders to urge the Company to consider and reach an amicable solution with the lenders, including, without limitation, repaying the loan in full, as soon as possible. In response to the R-Bridge Letter, management has provided the financial information to R-Bridge at its request and is currently working with the lenders under the facility agreement to negotiate a resolution. Management believes that, our current cash position, coupled with various measures being taken by us, such as increase product sales, strengthen the accounts receivable management and improve the ability of debt and equity financing to improve liquidity, will allow us to meet the working capital needs in the ordinary course of business. However, if lenders under the facility agreement are not satisfied and insist that we have defaulted under the facility agreement, such lenders may declare that all or part of the loan, the accrued interest, and all other amounts accrued or outstanding be immediately due and payable. If such lenders demand the prepayment of the loan in its full amount of \$40 million, the Company may be forced to seek additional funding to meet its obligation under the facility agreement, otherwise it may not be able to continue as a going concern.

Holding Company Structure

YS Biopharma is a holding company with no business operations of its own. YS Biopharma conducts a substantial portion of its business and operations through its PRC subsidiaries, in particular, Liaoning Yisheng and Beijing Yisheng, and a substantial portion of its assets are located in China. As a result, its ability to pay dividends and to service any debt it may incur overseas largely depends upon dividends paid by its subsidiaries. If its subsidiaries incur debt on their own behalf in the future, the instruments governing their debt may restrict their ability to pay dividends to YS Biopharma. Under Chinese law, the domestic companies are required to set aside at least 10% of their after-tax net income (after discharging all cumulated loss), if any, each year for compulsory statutory reserve until the reserve reaches 50% of the domestic companies’ registered capital.

In addition, YS Biopharma’s subsidiaries in China are permitted to pay dividends to their shareholder only out of their after-tax profits, if any, as determined in accordance with the Accounting Standards for Business Enterprise as promulgated by the Ministry of Finance of the PRC (the “PRC GAAP”). The aggregate Accumulated Deficit for its PRC subsidiaries as determined under the Accounting Standards for Business Enterprise were RMB509.2 million and RMB581.3 million (\$81.0 million) as of September 30, 2022 and 2023, respectively. In addition, pursuant to the relevant PRC laws, enterprises in the PRC have to make appropriation from their after-tax profit, as determined under PRC GAAP, to statutory common reserve funds. The appropriation to the statutory common reserve fund must be at least 10% of the after-tax profits calculated in accordance with PRC GAAP. Appropriation is not required if the reserve fund has reached 50% of the registered capital of such PRC enterprise. See “Business — Regulations” for a detailed discussion of the PRC legal restrictions on dividends and its ability to transfer cash within its group. In addition, holders of YS Biopharma’s securities may potentially be subject to PRC taxes on dividends paid by it in the event YS Biopharma is deemed as a PRC resident enterprise for PRC tax purposes. See “Material Taxation Consideration — Material PRC Tax Considerations” for more details.

None of YS Biopharma’s PRC subsidiaries have issued any dividends or distributions to respective holding companies, including YS Biopharma, or any investors as of the date of this prospectus. YS Biopharma’s subsidiaries in the PRC generate and retain cash generated from operating activities and re-invest it in its business. Historically, Liaoning

[Table of Contents](#)

Yisheng has also received equity financing from its shareholders to fund business operations of YS Biopharma's PRC subsidiaries. In the fiscal year ended March 31, 2021, 2022 and 2023 and six months ended September 30, 2023, YS Biopharma transferred cash proceeds of RMB428.5 million, RMB291.1 million, nil and nil to Liaoning Yisheng, respectively. In the six months ended September 30, 2023, YS Biopharma transferred cash proceeds of RMB7.2 million to Beijing Yisheng. In the future, cash proceeds raised from overseas financing activities may be transferred by YS Biopharma through its subsidiaries outside China to its PRC subsidiaries via capital contribution and shareholder loans, as the case may be. Its PRC subsidiaries will pay dividends to their offshore shareholder to meet the capital needs of YS Biopharma's business operations out of the PRC. For details about the applicable PRC regulations and rules relating to such cash transfers through YS Group and the associated risks, see "Risk Factors — Risks Related to Doing Business in China."

Cash is transferred among YS Biopharma, its offshore subsidiaries and its PRC subsidiaries, in the following manner: (i) funds are transferred to its PRC subsidiaries from YS Biopharma as needed through YS Biopharma's subsidiaries outside China as capital contributions or shareholder loans, as the case may be; and (ii) dividends or other distributions may be paid by its PRC subsidiaries to the Company through its subsidiaries outside China. Its subsidiaries in the PRC generate and retain cash generated from operating activities and re-invest it in its business. None of its subsidiaries outside China made distributions to shareholders. In the future, YS Biopharma's ability to pay dividends, if any, to its shareholders and warrant holders and to service any debt it may incur will depend upon dividends paid by its subsidiaries. In the three fiscal years ended March 31, 2021, 2022 and 2023 and six months ended September 30, 2023, YS Group did not transfer any cash proceeds to any of YS Group's PRC subsidiaries except for the cash transfers within YS Group in connection with the paid-in capital in YS Group's PRC subsidiaries. \$59,900,000 of the registered capital was paid up by HK Yisheng to Liaoning Yisheng during the fiscal year ended March 31, 2021. \$45,099,071.49 of the registered capital was paid up by HK Yisheng to Liaoning Yisheng during the fiscal year ended March 31, 2022. No registered capital was paid up by HK Yisheng to Liaoning Yisheng during the year ended March 31, 2023. \$1,008,767.58 of the registered capital was paid up by HK Yisheng to Beijing Yisheng during the six months ended September 30, 2023.

Off-Balance Sheet Arrangements

YS Group has no off-balance sheet arrangements. YS Group has not entered into any financial guarantees or other commitments to guarantee the payment obligations of any third parties. YS Group has not entered into any derivative contracts that are indexed to its shares and classified as shareholders' equity or that are not reflected in its consolidated financial statements. Furthermore, YS Group does not have any retained or contingent interest in assets transferred to an unconsolidated entity that serves as credit, liquidity, or market risk support to such entity. YS Group does not have any variable interest in any unconsolidated entity that provides financing, liquidity, market risk or credit support to YS Group or that engages in leasing, hedging or R&D services with it.

Internal Control over Financial Reporting

YS Biopharma is a private company with limited accounting personnel and other resources to address its ICFR. YS Group's management has not completed an assessment of the effectiveness of its internal control and procedures over financial reporting and its independent registered public accounting firm has not conducted an audit of its ICFR. In connection with the audit of its consolidated financial statements as of and for the years ended March 31, 2022 and 2023, YS Group and its independent registered public accounting firm identified a material weakness in its ICFR as of March 31, 2023. As defined in the standards established by the PCAOB, a "material weakness" is a deficiency, or combination of deficiencies, in the ICFR, such that there is a reasonable possibility that a material misstatement of its annual or interim consolidated financial statements will not be prevented or detected on a timely basis.

The material weakness identified relates to lack of sufficient competent financial reporting and accounting personnel with appropriate understanding of U.S. GAAP to design and implement formal period-end financial reporting policies and procedures to address complex U.S. GAAP technical accounting issue; and to prepare and review the Group's consolidated financial statements and related disclosures in accordance with U.S. GAAP and financial reporting requirements set forth by the SEC. To remediate its identified material weakness, YS Group has adopted measures to improve its ICFR, including, among others: (i) hiring additional qualified accounting and financial personnel with appropriate knowledge and experience in U.S. GAAP accounting and SEC reporting, and (ii) organizing regular training for its accounting staffs, especially training related to U.S. GAAP and SEC reporting requirements. YS Group also plans to adopt additional measures to improve its ICFR, including, among others, creating U.S. GAAP accounting

[Table of Contents](#)

policies and procedures manual, which will be maintained, reviewed and updated, on a regular basis, to the latest U.S. GAAP accounting standards, and further hiring executive accounting personnel with strong knowledge and experience in U.S. GAAP accounting and SEC reporting.

However, YS Group cannot assure you that all these measures will be sufficient to remediate its material weakness in time, or at all. See “Risk Factors — Risks Related to Ownership of the Ordinary Shares — If YS Group fails to remediate its material weakness and implement and maintain an effective system of internal controls over financial reporting, YS Group may be unable to accurately report its results of operations, meet its reporting obligations or prevent fraud.”

As a company with less than \$1.235 billion in revenue for its last fiscal year, YS Biopharma qualifies as an “emerging growth company” pursuant to the JOBS Act. An emerging growth company may take advantage of specified reduced reporting and other requirements that are otherwise applicable generally to public companies. These provisions include exemption from the auditor attestation requirement under Section 404 of the Sarbanes-Oxley Act of 2002 in the assessment of the emerging growth company’s ICFR.

Research and Development, Patents and Licenses

For information about YS Group’s proprietary intellectual properties and its R&D policies, see “Business.”

Trend Information

YS Biopharma is not aware of any trends, uncertainties, demands, commitments or events from April 1, 2023 to September 30, 2023 that are reasonably likely to have a material adverse effect on its operating revenues, profitability, liquidity or capital resources, or that would cause the disclosed financial information to be not necessarily indicative of future results of operations or financial conditions.

Critical Accounting Policies and Estimates

YS Group’s consolidated financial statements (“CFS”) have been prepared in accordance with generally accepted accounting principles in the United States. The preparation of CFS requires YS Group to make judgments and estimates that affect the reported amounts of assets, liabilities, revenues and expenses, and the disclosure of contingent assets and liabilities in YS Group’s financial statements. YS Group bases its estimates on historical experience, known trends and events and various other factors that YS Group believes are reasonable under the circumstances, the results of which form the basis for making judgments about the carrying values of assets and liabilities that are not readily apparent from other sources. YS Group evaluates its estimates and assumptions on an ongoing basis. YS Group’s actual results may differ from these estimates under different assumptions or conditions. On an ongoing basis, YS Group evaluates its judgments and estimates in light of changes in circumstances, facts, and experience. The effects of material revisions in estimates, if any, will be reflected in the consolidated financial statements prospectively from the date of change in estimates.

While YS Group’s significant accounting policies are described in more detail in Note 3 to the audited CFS appearing elsewhere in this Annual Report, YS Group believes that the following accounting policies are those most critical to the judgments and estimates used in the preparation of its financial statements.

Revenue from Contracts with Customers

YS Group follows ASC 606 — “Revenue from Contracts with Customers” for all periods presented. ASC 606 established principles for reporting information about the nature, amount, timing, and uncertainty of revenue and cash flows arising from YS Group’s contracts to provide services to customers. Based on the following five steps analysis, revenues from contracts with customers are recognized when control of the promised goods or services is transferred to the customers, in an amount that reflects the consideration YS Group expects to be entitled in exchange for those goods or services.

Step 1: Identify the contract with the customer;

Step 2: Identify the performance obligations in the contract;

Step 3: Determine the transaction price;

Step 4: Allocate the transaction price to the performance obligations in the contract; and

Step 5: Recognize revenue when YS Group satisfies a performance obligation.

[Table of Contents](#)

YS Group is principally engaged in the research, development, manufacturing and sale of vaccines and therapeutic biologics. YS Group's revenues primarily streams from the sales of vaccines.

The core principle underlying the revenue recognition ASC 606 is that YS Group recognizes revenue for the transfer of vaccines to customers in an amount that reflects the consideration to which YS Group expects to be entitled. This requires YS Group to identify contractual performance obligations and determine whether revenue should be recognized at a point in time or over time. YS Group's sales contracts of vaccines have one single performance obligation that is to sell vaccines to the customers. The sales contracts with customers do not involve variable considerations, such as discounts and rebates. And according to the historical operation, circumstance of discounts and rebates have never occurred. The customer pays after acceptance of the vaccines. According to ASC 606, the relevant revenue recognition is based on customer acceptance confirmation.

In accordance with ASC606-10-55-36 through 55-40, YS Group evaluates whether it is appropriate to record the gross amount of vaccines and related costs or the net amount earned as commissions. When the entity is a principal, that the entity obtains control of the specified goods or services before they are transferred to the customers, the revenues should be recognized in the gross amount of consideration to which it expects to be entitled in exchange for the specified goods or services transferred. When the entity is an agent and its obligation is to facilitate third parties in fulfilling their performance obligation for specified goods or services, the revenues should be recognized in the net amount for the amount of commission which the entity earns in exchange for arranging for the specified goods or services to be provided by other parties. Revenues are recorded net of value-added taxes. YS Group sells vaccines to the customers, and it obtains control of the vaccines before customer acceptance confirmation. Therefore, YS Group is a principal, and the revenues should be recognized according to the gross method.

Leases

Under ASC Topic 842, Leases ("ASC 842"), YS Group determines if an arrangement is or contains a lease at inception. For leases with a term of 12 months or less, YS Group does not recognize a right-of-use asset ("ROU") or lease liability. YS Group's operating leases are recognized on its consolidated balance sheets as noncurrent assets, current liabilities and noncurrent liabilities. YS Group does not have any finance leases.

ROU assets represent YS Group's right to use an underlying asset for the lease term and lease liabilities represent YS Group's obligation to make lease payments arising from the lease. Operating lease ROU assets and liabilities are recognized at the lease commencement date based on the present value of lease payments over the lease term. As YS Group's leases typically do not provide an implicit rate, YS Group uses an estimate of its incremental borrowing rate based on the information available at the lease commencement date in determining the present value of lease payments. The lease terms may include options to extend or terminate the lease when it is reasonably certain that YS Group will exercise that option. Lease expense is recognized on a straight-line basis over the lease term. For leases with terms greater than 12 months, YS Group records the related asset and lease liability at the present value of lease payments over the lease term. For leases with terms less than 12 months, YS Group records rents in administrative expenses.

Government grants

Government grants are primarily subsidies received from PRC governments for operating a business in their jurisdictions and in compliance with specific policies promoted by the government authorities. YS Group's PRC-based subsidiaries received specific subsidies and other subsidies from certain local governments. Specific subsidies are subsidies the local government has set certain conditions for the subsidies. Other subsidies are subsidies the local government has not set any conditions and are not tied to future trends or performance of YS Group, receipt of such subsidy is not contingent upon any further actions or performance of YS Group and the amounts do not have to be refunded under any circumstances. Specific subsidies are recorded as deferred government grants upon receipt and are recognized as government grants recognized in income when the conditions are met. Other subsidies are recognized as other income upon receipt as further performance by YS Group is not required.

Government grants for "R&D" are recognized as a reduction to R&D expenses when the conditions attached to the grants are met or recognized as government grants recognized in income in the period when the conditions are met after the expenses are incurred. Government grants for property, plant and equipment are deferred and recognized as a reduction to the related depreciation and amortization expenses in the same manner as the property, plant and equipment are depreciated.

Fair value measurements

ASC 825-10 requires certain disclosures regarding the “FV” of financial instruments. FV is defined as the price that would be received to sell an asset or paid to transfer a liability in an orderly transaction between market participants at the measurement date. A three-level fair value hierarchy prioritizes the inputs used to measure FV. The hierarchy requires entities to maximize the use of observable inputs and minimize the use of unobservable inputs. The three levels of inputs used to measure fair value are as follows:

- Level 1 — inputs to the valuation methodology are quoted prices (unadjusted) for identical assets or liabilities in active markets.
- Level 2 — inputs to the valuation methodology include quoted prices for similar assets and liabilities in active markets, quoted market prices for identical or similar assets in markets that are not active, inputs other than quoted prices that are observable and inputs derived from or corroborated by observable market data.
- Level 3 — inputs to the valuation methodology are unobservable.

Unless otherwise disclosed, the FV of YS Group’s financial instruments including cash, accounts receivable, advances to suppliers, amounts due from related parties, prepaid expenses and other current assets, short-term bank loans and other loans, accounts payable, warrant liabilities, and accrued expenses and other current liabilities approximate their recorded values due to their short-term maturities. The FV of longer-term leases approximates their recorded values as their stated interest rates approximate the rates currently available.

YS Group’s non-financial assets, such as property and equipment would be measured at FV only if they were determined to be impaired.

Impairment of Long-lived Assets

YS Group reviews long-lived assets, including definitive-lived intangible assets and property and equipment, for impairment whenever events or changes in circumstances indicate that the carrying amount of an asset may not be recoverable. When such events occur, YS Group assesses the recoverability of the asset group based on the undiscounted future cash flows the asset group is expected to generate and recognizes an impairment loss when estimated undiscounted future cash flows expected to result from the use of the asset group plus net proceeds expected from disposition of the asset group, if any, is less than the carrying value of the asset group. If YS Group identifies an impairment, YS Group reduces the carrying amount of the asset group to the estimated FV based on a discounted cash flow approach or, when available and appropriate, to comparable market values and the impairment loss, if any, is recognized in general and administrative expenses in the consolidated statements of operations. YS Group uses estimates and judgments in its impairment tests and if different estimates or judgments had been utilized, the timing or the amount of any impairment charges could be different. Asset groups to be disposed of would be reported at the lower of the carrying amount or FV less costs to sell, and no longer depreciated. YS Group did not record any impairment charges during the fiscal years ended March 31, 2021, 2022 and 2023 and the six months ended September 30, 2023.

Share-based Compensation

YS Group operates a share option scheme to provide incentives and rewards to eligible participants who contribute to the success of YS Group’s operations. Employees (including directors) of YS Group receive granted shares and share option in the form of share-based payments, whereby employees render services as consideration for equity instruments (“equity-settled transactions”).

The cost of equity-settled transactions with employees for grants is measured by reference to the fair value of the equity instruments at the date at which they are granted. The fair value is determined by an external valuer using a binomial model. The cost of equity-settled transactions is recognized in employee benefit expense, together with a corresponding increase in equity, over the period in which the performance and/or service conditions are fulfilled.

The cumulative expense recognized for equity-settled transactions at the end of each of the Relevant Periods until the vesting date reflects the extent to which the vesting period has expired and YS Group’s best estimate of the number of equity instruments that will ultimately vest. The charge or credit to the statement of profit or loss for a period

represents the movement in the cumulative expense recognized as at the beginning and end of that period. Service and non-market performance conditions are not taken into account when determining the grant date fair value of awards, but the likelihood of the conditions being met is assessed as part of the Group's best estimate of the number of equity instruments that will ultimately vest. Market performance conditions are reflected within the grant date fair value. Any other conditions attached to an award, but without an associated service requirement, are considered to be non-vesting conditions. Non-vesting conditions are reflected in the fair value of an award and lead to an immediate expensing of an award unless there are also service and/or performance conditions

For awards that do not ultimately vest because non-market performance and/or service conditions have not been met, no expense is recognized. Where awards include a market or non-vesting condition, the transactions are treated as vesting irrespective of whether the market or non-vesting condition is satisfied, provided that all other performance and/or service conditions are satisfied.

Where the terms of an equity-settled award are modified, as a minimum an expense is recognized as if the terms had not been modified, if the original terms of the award are met. In addition, an expense is recognized for any modification that increases the total fair value of the share-based payments or is otherwise beneficial to the employee as measured at the date of modification.

Where an equity-settled award is cancelled, it is treated as if it had vested on the date of cancellation, and any expense not yet recognized for the award is recognized immediately. This includes any award where non-vesting conditions within the control of either the Group or the employee are not met. However, if a new award is substituted for the cancelled award, and is designated as a replacement award on the date that it is granted, the cancelled and new awards are treated as if they were a modification of the original award, as described in the previous paragraph. When an equity-settled award is surrendered, any expense recognized for the award is reversed immediately.

Recently Issued Accounting Pronouncements

In June 2016, the FASB issued Accounting Standards Update ("ASU") 2016-13, Financial Instruments — Credit Losses (Topic 326). The amendments in this Update require a financial asset (or a group of financial assets) measured at amortized cost basis to be presented at the net amount expected to be collected. The amendments broaden the information that an entity must consider in developing its expected credit loss estimate for assets measured either collectively or individually. The use of forecasted information incorporates more timely information in the estimate of expected credit loss, which will be more decision useful to users of the financial statements. This ASU is effective for annual and interim periods beginning after December 15, 2019 for issuers and December 15, 2020 for non-issuers. Early adoption is permitted for all entities for annual periods beginning after December 15, 2018, and interim periods therein. In May 2019, the FASB issued ASU 2019-05, Financial Instruments — Credit Losses (Topic 326): Targeted Transition Relief. This ASU adds optional transition relief for entities to elect the fair value option for certain financial assets previously measured at amortized cost basis to increase comparability of similar financial assets. The ASUs should be applied through a cumulative-effect adjustment to retained earnings as of the beginning of the first reporting period in which the guidance is effective (that is, a modified retrospective approach). On November 19, 2019, the FASB issued ASU 2019-10 to amend the effective date for ASU 2016-13 to be fiscal years beginning after December 15, 2022 and interim periods therein. YS Group is still evaluating the impact of accounting standard of credit losses on YS Group's CFS.

In December 2019, the FASB issued ASU 2019-12, Income Taxes (Topic 740): Simplifying the Accounting for Income Taxes, which removes certain exceptions to the general principles in Topic 740, and improves consistent application of and simplify U.S. GAAP for other areas of Topic 740 by clarifying and amending existing guidance. For public business entities, the amendments in this update are effective for fiscal years, and interim periods within those fiscal years, beginning after December 15, 2020. For all other entities, the amendments in this update are effective for fiscal years beginning after December 15, 2021, and interim periods within fiscal years beginning after December 15, 2022. Early adoption of the amendments is permitted. YS Group will adopt this ASU within annual reporting period of March 31, 2023 and expects that the adoption of this ASU did not have a material impact on YS Group's CFS.

YS Group does not believe other recently issued but not yet effective accounting standards, if currently adopted, would have a material effect on YS Group's consolidated financial position, statements of Income and comprehensive income and cash flows.

JOBS Act

On April 5, 2012, the JOBS Act was signed into law. The JOBS Act contains provisions that, among other things, relax certain reporting requirements for qualifying public companies. YS Group will qualify as an “emerging growth company” and under the JOBS Act and will be allowed to comply with new or revised accounting pronouncements based on the effective date for private (not publicly traded) companies. YS Group is electing to delay the adoption of new or revised accounting standards, and as a result, YS Group may not comply with new or revised accounting standards on the relevant dates on which adoption of such standards is required for non-emerging growth companies. As a result, YS Group’s financial statements may not be comparable to companies that comply with new or revised accounting pronouncements as of public company effective dates.

Quantitative and Qualitative Disclosures about Market Risk and Credit Risk

Credit Risk

Credit risk is controlled by the application of credit approvals, limits and monitoring procedures. YS Group manages credit risk through in-house research and analysis of the Chinese economy and the underlying obligors and transaction structures. YS Group identifies credit risk collectively based on industry, geography and customer type. In measuring the credit risk of YS Group’s sales to its customers, YS Group mainly reflects the “probability of default” by the customer on its contractual obligations and consider the current financial position of the customer and the current and likely future exposures to the customer.

Inflation risk

Inflationary factors, such as increases in the cost of raw materials, personnel and overhead costs, could impair YS Group’s operating results. To date, the inflation in China has not materially affected its results of operations. According to the National Bureau of Statistics of China, the year-over-year percent changes in the consumer price index for December 2022 and 2023 were increases of 1.5% and 0.7%, respectively. Although YS Group does not believe that inflation has had a material impact on its financial position or results of operations to date, a high rate of inflation in the future may have an adverse effect on YS Group’s ability to maintain current levels of gross margin and operating expenses as a percentage of sales revenue if the revenues from YS Group’s products do not increase with such increased costs.

Interest rate risk

YS Group’s exposure to interest rate risk primarily relates to the interest rate that its deposited cash can earn, on the other hand, interest-earning instruments carry a degree of interest rate risk. YS Group has not been exposed to material risks due to changes in interest rates. An increase, however, may raise the cost of any debt YS Group incurs in the future.

Foreign Exchange Risk

While YS Group’s reporting currency is Renminbi, almost all of its financing fund are denominated in U.S. dollar. As a result, YS Group is exposed to foreign exchange risk as its financing fund may be affected by fluctuations in the exchange rate between the U.S. dollar and Renminbi. YS Group has not entered into any hedging transactions in an effort to reduce its exposure to foreign exchange risk.

SUBSEQUENT EVENTS

See Note 21 to the audited consolidated financial statements appearing elsewhere in this prospectus for the subsequent events.

MANAGEMENT**Directors and Senior Management**

The following table sets forth certain information relating to our executive officers and directors as of the date of this prospectus. Our board of directors is composed of seven directors.

Name	Age	Position
Mr. Yi Zhang	67	Director
Dr. Hui Shao	56	Director, President and Chief Executive Officer
Mr. Bo Tan	50	Director
Dr. Ajit Shetty	77	Independent Director and Interim Chairperson
Dr. Viren Mehta	74	Independent Director
Ms. Rui Yu	49	Independent Director
Mr. Shaojing Tong	52	Independent Director
Dr. Zenaïda Reynoso Mojares	66	Chief Medical Officer
Ms. Chunyuan Wu	45	Chief Financial Officer
Dr. Yuan Liu	37	Head of vaccine research
Mr. Gang Li	42	Head of marketing and sales

Mr. Yi Zhang is the founder of YS Group and has served as director of YS Group since November 16, 2020, including as the chairman of the board of YS Group from November 16, 2020 to December 9, 2023. Mr. Zhang has over 30 years of experience in research, development and commercialization of immunological biologics and vaccines. Since the inception of Yisheng Biopharma Co., Ltd. (“Yisheng Biopharma”), the predecessor of YS Biopharma in February 2010, Mr. Zhang has been its director. He was the chief executive officer of Yisheng Biopharma from February 2010 to February 2018. Mr. Zhang has been the chairman of the board of Liaoning Yisheng since April 2005. He was the inventor of the first aluminum-free rabies vaccine and human rabies immunoglobulin in China. Mr. Zhang was selected as the member of the European Academy of Natural Sciences in December, 2023. He was also the project leader of national 863 scientific project “SARS Immunoglobulin” and several other national key medical innovation projects funded by Chinese government. From June 1986 to May 2002, Mr. Zhang served as a physician and as the division head of Kaifeng Suburb CDC. From August 1981 to May 1986, Mr. Zhang was a physician for epidemic prevention in Zhongmou County CDC.

Mr. Zhang graduated from Kaifeng Health Science School in October 1981 with a major in clinical medicine. Mr. Zhang is also the director in the Henan Red Cross Society.

Dr. Hui Shao has served as the executive director and chief executive officer of YS Group since December 31, 2020 and is serving as the Director and Chief Executive Officer of YS Biopharma. Dr. Shao served as the director, president and chief executive officer of Yisheng Biopharma from February 2018 to December 2020, and prior to that, as the chief financial officer and global business head of the same company since October 2010. Dr. Shao served as the senior vice president of finance and then the chief financial officer of Aoxing Pharmaceutical Company, Inc. from January 2007 to October 2010, where he was responsible for preparing financial statements in accordance with U.S. GAAP and SEC rules and regulations. From 2005 to 2007, Dr. Shao was a senior biotechnology analyst at Kamunting Street Capital Management in New York. From 2003 to 2005, Dr. Shao was a healthcare analyst at Mehta Partners in New York. Prior to that, Dr. Shao had spent five years as a principal scientist at Roche Pharmaceuticals, USA.

Dr. Shao received his bachelor’s degree in chemistry from University of Science & Technology of China in 1991, his Ph.D. degree in bioorganic chemistry from University of California, San Diego in 1996, and an M.B.A. degree in finance and accounting from Stern School of Business, New York University in 2003. Dr. Shao is a chartered financial analyst and AICPA holder in the State of Washington, the United States.

Mr. Bo Tan, is serving as a Director of YS Biopharma. Mr. Tan has over 20 years of extensive experience in the financial and pharmaceutical industries. He is the founding partner of Hannut Capital since 2021 and was the President and Chief Financial Officer of 3S Bio from December 2016 to December 2019. During his tenure at 3S Bio, Mr. Tan led the privatization of 3SBio and its re-listing in Hong Kong in 2015, as well as the acquisition and integration of Sciprogen, Sirton (Italy), Wanma and CP Guojian. From 2015 to 2019, Mr. Tan was voted the “Best CFO” for consecutive years in the Institutional Investor All-Asia Executive Team poll. Before joining 3S Bio, Mr. Tan served as the executive director and a member of Investment Committee of Bohai Industrial Investment Fund Management

[Table of Contents](#)

Company, a PRC-based private equity firm, and presided over the investment in The Chengdu Commercial Bank, from April 2007 to September 2008. Prior to that, Mr. Tan served as a vice president in the equity research division of Lehman Brothers Asia Limited from March 2006 to March 2007 and as a senior analyst at Macquarie Securities Asia in Hong Kong from October 2004 to February 2006. Mr. Tan is widely acclaimed for his stellar track record of combining business operations and capital market prowess and has long-standing strategic relationships with major MNCs.

Mr. Tan received his bachelor's degree in economics from Renmin University of China in July 1994, master's degree in economics from the University of Connecticut in December 1996 and a Master of International Management from Thunderbird School of Global Management in August 1998.

Dr. Ajit Shetty, has served as the independent non-executive director of YS Group since January 2021 and is serving as independent director of YS Biopharma. Dr. Shetty also is serving as an interim Chairperson of the Board for a six-month period effective from December 9, 2023. Dr. Shetty has served as a director of Actinium Pharmaceuticals, Inc., a company listed on the New York Stock Exchange (ATNM.US), since March 2017. He has also been a director of Agile Therapeutics, Inc., a company listed on the Nasdaq (AGRX.US), since February 2016. He has been an independent director of reMYND NV since August 2012. From February 2004 to February 2012, Dr. Shetty served as the chairman of the board of directors of Janssen Pharmaceutica NV, a pharmaceutical company and subsidiary of Johnson & Johnson, a company listed on the New York Stock Exchange (JNJ.US). From July 2007 to February 2012, he served as the Global Head of the enterprise supply chain in Johnson & Johnson and was a member of the corporate operating committee.

Dr. Shetty is a member of the Board of Trustees of Carnegie Mellon University. In 2004, Dr. Shetty was elected as Manager of the Year in Flanders, Belgium. In 2007, Dr. Shetty received the title of Baron for his exceptional merits and contribution to the country of Belgium. In 2008, he was conferred an honorary doctorate by Manipal University (India). In 2016, Dr. Shetty was named as Chairperson of the Flemish Institute of Biotechnology (VIB), a Belgium-based life sciences research institute with a focus on translating scientific results into pharmaceutical, agricultural and industrial applications.

Dr. Shetty received a Ph.D. degree in metallurgy and a master's degree in natural sciences from Trinity College, Cambridge University in April 1972 and June 1968, respectively. He also received an M.B.A. degree from Carnegie Mellon University in June 1974.

Dr. Viren Mehta, has served as the independent non-executive director of YS Group since January 2021 and is serving as independent director of YS Biopharma. Dr. Mehta has an extensive experience in investment research and strategic advisory services, focusing on the pharmaceutical and biotechnology industry. He is the founder and managing member of Mehta Partners, LLC since February 1997. He has been a director of Onconova Therapeutics Inc., a company listed on Nasdaq (ONTX.US), since February 2004. From April 2013 to December 2017, Dr. Mehta served as the executive chair and co-founder of Gather Health Ltd, one of the early telehealth initiatives based in Hong Kong. Dr. Mehta served as a director of BlinkBio Inc. from September 2010 to December 2020. From November 1999 to June 2010, Dr. Mehta served as a director of OSI Pharmaceuticals Inc., when Astellas of Japan acquired OSI for \$4 billion. Dr. Mehta also actively works with not-for-profit-enterprises around the world focused on education, ecology, and healthcare.

Dr. Mehta received his Ph.D. degree of pharmacy from the University of Southern California in August 1974 and his M.B.A. degree from the University of California, Los Angeles in December 1980.

Ms. Rui Yu, aged 49, has served as the independent non-executive director of YS Group since January 2024 and is serving as independent director of YS Biopharma. She has served as a partner at Oceanpine Capital's healthcare practice since May 2021, where she is responsible for formulating the overall investment strategies in the healthcare sector and taking day-to-day principal leadership responsibility in financial and operational management of financial team, investment team and portfolio companies. Prior to that, she was a managing director at China Renaissance Group, where she worked from 2014 to 2021 and took the principal responsibility in deal sourcing, and conducting due diligence on investment targets, including financial and operational data, financial models and valuation and compliance. From 2012 to 2014, Ms. Yu served as vice president/head of China healthcare research at Gerson Lehman Group. Prior to that, Ms. Yu worked as an equity analyst at Maxim Group, Rodman & Renshaw, and Deutsche Bank Securities. Rui Yu was a research scientist focusing on pharmaceutical research and development at Genentech Inc, South San Francisco, California, for approximately five years. Ms. Yu received her Bachelor of Science degree from Guangdong Pharmaceutical University, her Master of Science degree from the University of Missouri School of Medicine, and her M.B.A. from the University of Chicago Booth School of Business with concentrations in finance, accounting and entrepreneurship.

Mr. Shaojing Tong, is serving as an independent director of YS Biopharma. Mr. Tong, who has nearly 20 years of experience in investment banking focusing on the global healthcare sector, has acquired an in-depth understanding of both the U.S. and Asian healthcare markets. He has served as the chief financial officer of InnoCare Pharma Limited, a company listed on the Stock Exchange (9969.HK) since June 2019. From July 2013 to May 2019, Mr. Tong was employed by UBS AG with his last position as executive director in the investment banking research department. From May 2008 to May 2013, Mr. Tong was employed by Bank of America Merrill Lynch with his last position as director in global research. From June 2001 to April 2008, Mr. Tong served as an equity analyst in global pharmaceutical equity research at Mehta Partners.

Mr. Tong received his bachelor's degree in material science and engineering from the University of Science and Technology of China (Hefei) in July 1993, his master's degree in chemistry from the University of Pittsburgh in August 1996 and an M.B.A. degree in finance from New York University in May 2001.

Dr. Zenaida Reynoso Mojares, has served as the chief medical officer of YS Group since January 2022 and is serving as the Chief Medical Officer of YS Biopharma. She is responsible for the strategy, direction and execution of the R&D and global clinical trial programs. Dr. Mojares is responsible for the strategy, direction and execution of the R&D and global clinical development and clinical operations. Dr. Mojares is a highly accomplished medical professional with diverse experience in medical, clinical research, pharmacovigilance and public health in both private and national government sectors. From July 2021 to January 2022 and from August 2020 to June 2021, she served as the Chief Medical Officer and the Head of Clinical Development & Regulatory department respectively at the International Vaccine Institute in Seoul, South Korea. Her responsibilities included execution and delivery of funded clinical trials, supporting the development of new project opportunities, supervising the clinical team and developing clinical strategy. From June 2017 to July 2020, she served as the Regional Medical Director at Takeda Pharmaceuticals International AG, Vaccines Business Unit in Zurich, Switzerland. From March 2016 to June 2017, she served as the Senior Clinical Research & Development Lead at GSK Vaccines in Singapore and eventually relocated to GSK Vaccines Srl, R&D Center in Italy and was responsible for clinical development activities. From March 2015 to February 2016, she served as the chief medical officer, ad interim and lead regional physician in GlaxoSmithKline Pte Limited Singapore. From July 2011 to March 2015, she served several positions including Region International Physician Lead in Novartis Asia Pacific Pharmaceuticals Pte Ltd.

Dr. Mojares received her bachelor's degree of Science in General from University of Santo Tomas in 1979 and received her Doctor of Medicine degree from Perpetual Help College of Medicine in 1990. She is a Diplomate of the Philippine College of Gerontology & Geriatrics in 2004. She also received a Master of Science degree in Vaccinology and Pharmaceutical Clinical Development from Università degli Studi di Siena and Novartis Vaccines & Diagnostics, Siena Italy, in April 2011 and a master's degree in public health from University of the Philippines in 2004.

Ms. Chunyuan Wu, has served as the chief financial officer of YS Group since December 31, 2020 and is serving as the Chief Financial Officer of YS Biopharma. She is responsible for the overall finance management, including designing and developing objectives on tax planning, structuring bank loans for its subsidiaries, overseeing daily operation of the financial team, and working with external advisers for business expansion. Ms. Wu served as the chief financial officer of YS Group Biopharma from February 2018 to December 2020, after five years of serving as the financial controller at the same company since February 2013. From September 2010 to December 2012, Ms. Wu was the financial controller of Jilin Milk Ground Group where she oversaw the financial operation of the company, and was responsible for the preparation of the financial statements in accordance with IFRS and PRC GAAP. From October 2005 to August 2010, Ms. Wu served as a senior auditor at Ernst & Young. From January 2005 to September 2005, she served as an auditor of Shine Wing.

Ms. Wu graduated from Business School of Washington State University (Pullman) in May 2001 with double majors in accounting and finance and minor in economics. Ms. Wu has achieved FCCA and CPABC.

Dr. Yuan Liu, has served as the head of vaccine research of YS Group since January 2019 and is serving as the head of vaccine research of YS Biopharma. She is responsible for the R&D of vaccine adjuvant, including PIKA hepatitis B vaccine, human PIKA rabies vaccine and new adjuvant-based tumor vaccine under development. Dr. Liu also served as the project leader of R&D department of YS Group Xingye from July 2014 to January 2019 and subsequently has served as the vice president of research department of YS Group Xingye since January 2019. Dr. Liu has focused on the research of vaccine adjuvants for over 10 years. In 2016, she won the sponsorship of young backbone individual project by Beijing outstanding talent training fund.

[Table of Contents](#)

Dr. Liu received her Ph.D. degree in University of Chinese Academy of Sciences in July 2014. She received her bachelor's degree in Sun Yat-sen University in July 2008.

Mr. Gang Li, has served as the head of marketing and sales of YS Group since March 2019. He is responsible for the management of the overall marketing system. Prior to joining YS Group, he had served in GlaxoSmithKline (China) Investment Co., Ltd. since July 2009, responsible for the daily business management of the certain vaccine in North China. From May 2009 to June 2009, he served as a medical information specialist in Pfizer Investment Co., Ltd. From September 2006 to April 2009, he served as a pharmaceutical representative of GSK. From July 2003 to July 2006, he served in the sales department of Shenwei Pharmaceutical Ltd.

Mr. Li received his bachelor's degree in Hebei Medical University in July 2003. He received an M.B.A. degree in Sorbonne Business School in May 2018.

Board of Directors

The board of directors of YS Biopharma consists of seven directors. Of these seven directors, four are independent. The Amended YS Biopharma Articles provide that the minimum number of directors shall be three. A director is not required to hold any shares in YS Biopharma by way of qualification. A director may vote in respect of any contract or proposed contract or arrangement in which such director may be interested provided that (1) the nature of his/her interest is declared at a meeting of the directors, either specifically or by way of a general notice, and subject to the Nasdaq rules and disqualification by the chairperson of the relevant Board meeting, such director's vote may be counted in the quorum at any meeting of directors at which any such contract or proposed contract or arrangement is considered, and (2) if such contract or arrangement is a transaction with a related party, such transaction has been approved by the audit committee. The directors may exercise all the powers of YS Biopharma to raise or borrow money, mortgage or charge its undertaking, property and assets (present and future) and uncalled capital, and issue debentures or other securities whether outright or as security for any obligation of YS Biopharma or of any third party. No YS Biopharma non-employee director has a service contract with YS Biopharma that provides for benefits upon termination of service.

Duties of Directors

Under Cayman Islands law, the board of directors of YS Biopharma has the powers necessary for managing, and for directing and supervising, its business affairs. The functions and powers of the board of directors of YS Biopharma include, among others:

- convening shareholders' annual and extraordinary general meetings and reporting its work to shareholders at such meetings;
- declaring dividends and distributions;
- appointing officers and determining the term of office of the officers;
- exercising the borrowing powers of YS Biopharma and mortgaging the property of YS Biopharma; and
- approving the transfer of shares in YS Biopharma, including the registration of such shares in its share register.

Under Cayman Islands law, directors owe the following fiduciary duties: (1) duty to act in good faith in what the director believes to be in the best interests of the company as a whole; (2) duty to exercise powers for the purposes for which those powers were conferred and not for a collateral purpose; (3) directors should not improperly fetter the exercise of future discretion; (4) duty not to put themselves in a position in which there is a conflict between their duty to the company and their personal interests; and (5) duty to exercise independent judgment. In addition to the above, directors also owe a duty to exercise the skill they actually possess and such care and diligence that a reasonably prudent person would exercise in comparable circumstances.

[Table of Contents](#)

As set out above, directors have a duty not to put themselves in a position of conflict and this includes a duty not to engage in self-dealing, or to otherwise benefit as a result of their position. However, in some instances what would otherwise be a breach of this duty can be forgiven and/or authorized in advance by the shareholders provided that there is full disclosure by the directors. This can be done by way of permission granted in the memorandum and articles of association or alternatively by shareholder approval at general meetings.

Appointment and Removal of Directors

The Amended YS Biopharma Articles provide that all directors may be appointed by ordinary resolution and removed by ordinary resolution except with regard to the removal of the chairperson of the Board, who may be removed from office by special resolution. In addition, YS Biopharma's Board may appoint any person as a director, to fill a casual vacancy on YS Biopharma's Board or as an addition to the existing Board. A director may be removed from office by notice addressed to them at their last known address and signed by all of their co-directors (not being less than two in number). YS Biopharma's directors do not serve for a fixed term and there is no requirement for them to retire by rotation nor to make themselves eligible for re-election.

The office of a director shall be vacated if (1) such director resigns their office by notice in writing to YS Biopharma; (2) such director becomes bankrupt or makes any arrangement or composition with such director's creditors generally; (3) such director dies or is found to be or becomes of unsound mind; (4) such director is removed from office by notice addressed to such director at their last known address and signed by all of the co-directors (not being less than two in number); or (5) such director is removed from office by ordinary resolution.

Terms of Directors and Officers

A director shall hold office until such time as he or she resigns his office by notice in writing to YS Biopharma, is removed from office by ordinary resolution or is otherwise disqualified from acting as a director or removed in accordance with the Amended YS Biopharma Articles. An appointment of a director may be on terms that the director shall automatically retire from office (unless he has sooner vacated office) at the next or a subsequent annual general meeting or upon any specified event or after any specified period in a written agreement between YS Biopharma and the director, if any; but no such term shall be implied in the absence of express provision.

Employment Agreements and Indemnification Agreements

Each of the executive officers is party to an employment agreement with YS Biopharma. Under these agreements, the employment of each of executive officers is for a specified time period, and may be terminated for cause, at any time, for certain acts of the executive officer, such as continued failure to satisfactorily perform, willful misconduct or gross negligence in the performance of agreed duties, conviction or entry of a guilty or nolo contendere plea of any felony or any misdemeanor involving moral turpitude, or dishonest act that results in material to its detriment or material of the employment agreement. The employment may also be terminated without cause upon 60-to-120 day advance written notice. The executive officer may resign at any time with a 60-to-120 day advance written notice.

The employment agreements with the other executive officers also include confidentiality and non-disclosure restrictions and non-competition and non-solicitation restrictions that apply during employment for certain periods following termination of employment.

YS Biopharma will enter into indemnification agreements with each of its directors and executive officers. Under these agreements, YS Biopharma may agree to indemnify its directors and executive officers against certain liabilities and expenses incurred by such persons in connection with claims made by reason of their being a director or officer of YS Biopharma.

Board Committees

YS Biopharma Board has an audit committee, a compensation committee and a nominating and corporate governance committee. Each committee's members and functions are described below.

YS Biopharma's Board has determined that each of Rui Yu, Shaojing Tong, Ajit Shetty and Viren Mehta satisfies the requirements for an "independent director" within the meaning of the Nasdaq listing rules and the criteria for independence set forth in Rule 10A-3 of the Exchange Act.

Audit Committee

The audit committee consists of Rui Yu, Shaojing Tong and Viren Mehta. Rui Yu is the chairperson of the audit committee. Rui Yu satisfies the criteria of an audit committee financial expert as set forth under the applicable rules of the SEC.

The audit committee oversees YS Biopharma's accounting and financial reporting processes. The audit committee is responsible for, among other things:

- appointing the independent auditors and pre-approving all auditing and non-auditing services permitted to be performed by the independent auditors;
- reviewing with the independent auditors any audit problems or difficulties and management's response;
- discussing the annual audited financial statements with management and the independent auditors;
- reviewing the adequacy and effectiveness of YS Biopharma's accounting and internal control policies and procedures and any steps taken to monitor and control major financial risk exposures;
- reviewing and approving all proposed related party transactions;
- meeting separately and periodically with management and the independent auditors;
- monitoring compliance with YS Biopharma's code of business conduct and ethics, including reviewing the adequacy and effectiveness of YS Biopharma's procedures to ensure proper compliance.

Compensation Committee

The compensation committee consists of Viren Mehta, Ajit Shetty, Rui Yu and Shaojing Tong. Viren Mehta is the chairperson of the compensation committee.

The compensation committee is responsible for, among other things:

- reviewing and approving, or recommending to the board for its approval, the compensation for YS Biopharma's chief executive officer and other executive officers;
- reviewing and recommending to the board for determination with respect to the compensation of YS Biopharma's non-employee directors;
- reviewing periodically and approving any incentive compensation or equity plans, programs or similar arrangements; and
- the selection of compensation consultant, legal counsel or other adviser only after taking into consideration all factors relevant to that person's independence from management.

Nominating and Corporate Governance Committee

The nominating and corporate governance committee consists of Ajit Shetty, Viren Mehta, Rui Yu and Yi Zhang. Ajit Shetty is the chairperson of the nominating and corporate governance committee.

The nominating and corporate governance committee is responsible for, among other things:

- selecting and recommending to YS Biopharma's Board nominees for election by the shareholders or appointment by YS Biopharma's Board;
- reviewing annually with YS Biopharma's Board the current composition of YS Biopharma's Board with regard to characteristics such as independence, knowledge, skills, experience and diversity;
- making recommendations on the frequency and structure of YS Biopharma Board meetings and monitoring the functioning of the committees of YS Biopharma's Board; and
- advising YS Biopharma's Board periodically with regard to significant developments in the law and practice of corporate governance as well as YS Biopharma's compliance with applicable laws and regulations, and making recommendations to YS Biopharma's Board on all matters of corporate governance and on any remedial action to be taken.

Code of Business Conduct and Ethics

YS Biopharma has adopted a Code of Business Conduct and Ethics applicable to its directors, officers and employees. YS Biopharma seeks to conduct business ethically, honestly, and in compliance with applicable laws and regulations. YS Biopharma's Code of Business Conduct and Ethics sets out the principles designed to guide YS Biopharma's business practices- compliance, integrity, respect and dedication. The code applies to all directors, officers, employees and extended workforce, including the Chairperson and Chief Executive Officer and Chief Financial Officer. Relevant sections of the code also apply to members of YS Biopharma's Board. YS Group expects its suppliers, contractors, consultants, and other business partners to follow the principles set forth in its code when providing goods and services to YS Biopharma or acting on YS Biopharma's behalf.

Compensation of Directors and Executive Officers

In the fiscal year ended March 31, 2023, YS Group paid RMB10.8 million in cash compensation and benefits in kind to YS Biopharma's directors and executive officers as a group, and YS Group did not pay any cash compensation to its non-executive directors except for independent directors. Each of YS Biopharma's directors and officers is entitled to reimbursement for all necessary and reasonable expenses properly incurred in the course of employment or service. YS Biopharma has not set aside or accrued any amount to provide pension, retirement or other similar benefits to its executive officers and directors, except that YS Biopharma's subsidiaries in the PRC are required by law to make contributions equal to certain percentages of each employee's salary for his or her pension insurance, medical insurance, unemployment insurance and other statutory benefits and a housing provident fund. YS Biopharma's board of directors may determine compensation to be paid to the directors and the executive officers. The compensation committee will assist the directors in reviewing and approving the compensation structure for the directors and the executive officers.

For information regarding share awards granted to YS Biopharma's directors and executive officers, see "— Share Incentive Plans."

Share Incentive Plans

On December 31, 2020, YS Group's board of directors adopted the 2020 Share Incentive Plan of YS Group (the "YS Biopharma 2020 Plan") for the purpose of granting share-based compensation awards to employees, directors and consultants to incentivize their performance and align their interests with YS Group. Pursuant to such plan, YS Biopharma is entitled to grant awards to directors, employees and consultants of YS Group with rights to subscribe for up to 35,000,000 underlying ordinary shares of YS Biopharma (prior to the YS Biopharma Share Consolidation).

YS Biopharma has approved and adopted the amended and restated YS Biopharma 2020 Share Incentive Plan (the "YS Biopharma 2022 Plan") to resume all the terms and conditions of the YS Biopharma 2020 Plan to continue to incentivize directors, employees and consultants of YS Biopharma and its subsidiaries for future development of its business and R&D activities.

The following summarizes the material terms of the YS Biopharma 2022 Plan:

Shares Subject to the Plan. Initially, the maximum number of Ordinary Shares that may be issued under the YS Biopharma 2022 Plan will be 6,656,582 Ordinary Shares. If an award terminates, expires, or lapses for any reason without having been exercised or settled in full, the number of shares subject to the award shall again be available for the grant of an award pursuant to the YS Biopharma 2022 Plan.

Types of awards. The plan administrator shall determine the type or types of award(s) to be made to each selected eligible person. The types of awards that may be granted under the YS Biopharma 2022 Plan include share options, share appreciation rights, restricted share units and other awards approved by the plan administrator.

Plan Administration. The YS Biopharma 2022 Plan shall be subject to the administration of YS Biopharma's Board or one or more committees or person as authorized and appointed by YS Biopharma's Board. Pursuant to the YS Biopharma 2022 Plan, the committee shall be comprised solely of one or more directors or such number of directors as may be required under applicable laws as the plan administrator. The plan administrator shall have the right to (i) determine eligibility and the particular eligible persons who will receive an award under the YS Biopharma 2022 Plan; (ii) grant awards, determine the price and the number of securities and other terms (e.g., any performance

[Table of Contents](#)

criteria upon which the exercise of an option or the settlement of an award is conditioned) of awards granted thereto; (iii) approve the forms of award agreements; (iv) construe and interpret the terms of the YS Biopharma 2022 Plan and any agreements in relation to the YS Biopharma 2022 Plan; (v) prescribe, amend and rescind rules and regulations relating to the Plan; (vi) modify or amend each award; and (vi) make such other decisions or take any other action as it shall deem appropriate in the administration of the YS Biopharma 2022 Plan.

Award Agreement. Each award shall be evidenced by a written award agreement in the form approved by the plan administrator and executed on behalf of YS Biopharma or as required by the plan administrator. The award agreement shall set forth the material terms and conditions of the award as established by the plan administrator consistent with the express limitations of the YS Biopharma 2022 Plan.

Eligibility. Persons eligible to participate in the YS Biopharma 2022 Plan will be those officers, employees and directors of any member of the proposed listing group, individual consultant or adviser as selected from time to time by the administrator of this plan. However, persons eligible to participate in the performance-based awards will be those officers and employees of any member of the proposed listing group.

Effect of termination of services. Unless YS Biopharma's Board otherwise expressly provides, (1) if an outstanding option granted under such plan has not become vested and exercisable on the date the participant's employment by or service to the proposed listing group terminates, the option to the extent unvested and unexercisable shall terminate, and (2) any shares subject to a restricted share award that remain subject to restrictions at the time the participant's employment by or service to the proposed listing group terminates shall not vest and YS Biopharma shall have the right to reacquire any such unvested shares subject to such award in such manner and on such terms as the administrator provides, which terms shall include return or repayment of the lower of the fair market value or the original purchase price of the restricted shares, without interest, to the participant to the extent not prohibited by law.

Performance Criteria. YS Biopharma 2022 Plan allows the administrator to establish the performance criteria when granting stock options on the basis of any one of, or combination of, earnings per share, cash flow, total shareholder return, gross revenue, revenue growth, operating income (before or after taxes), net earnings, return on equity, return on assets, return on investment, cost containment or reduction. The applicable performance measurement period may not be less than three months nor more than 10 years.

Vesting Schedule. In general, the plan administrator determines the vesting schedule, which is specified in the relevant award agreement.

Exercise of options. The plan administrator determines the exercise price for each award, which is stated in the award agreement. The vested portion of option will expire if not exercised prior to the time as the plan administrator determines at the time of its grant. However, the maximum exercisable term is 10 years.

Transfer restrictions. Unless otherwise determined by the plan administrator and so provided in the applicable award agreement, all awards are non-transferable and shall not be subject in any manner to sale, transfer, anticipation, alienation, assignment, pledge, encumbrance or charge. All awards shall be exercised only by the grantee and amounts payable or shares issuable pursuant to any award shall be delivered only to (or for the account of) the grantee.

Dissolution, Liquidation or Change in Control. Upon a dissolution, liquidation of YS Biopharma or other events that YS Biopharma do not survive (or does not survive as a public company in respect of its ordinary shares), then each then outstanding option and share appreciation right shall become fully vested, all outstanding restricted shares shall fully vest free of restrictions, and all other outstanding awards granted under the YS Biopharma 2022 Plan shall become payable to the holders of such awards; provided that such acceleration provision shall not apply, unless otherwise expressly provided by the administrator, with respect to any award to the extent that the administrator has made a provision for the substitution, assumption, exchange or other continuation or settlement of the award, or the award would otherwise continue in accordance with its terms, in the circumstances. In the event of a change in control event, the administrator may, in its discretion, provide that any outstanding options or share appreciation rights shall become fully vested, that any restricted shares shall fully vest free of restrictions, and that any other outstanding awards granted under the YS Biopharma 2022 Plan shall be payable to the holders of such awards. The administrator may take such action with respect to all outstanding awards or only with respect to certain specific awards identified by the administrator.

[Table of Contents](#)

Payment. The consideration to be paid for the shares to be issued under the YS Biopharma 2022 Plan, including the method of payment, shall be determined by the plan administrator subject to the provisions in the YS Biopharma 2022 Plan and applicable law. The tax withholding to be paid for the shares shall be determined according to the provisions in the plan and applicable law.

Duration. Subject to the termination provisions under the YS Biopharma 2022 Plan, the YS Biopharma 2022 Plan shall be valid and effective for a period of 10 years commencing on the effective date after which period no further awards will be granted, but previously granted awards (and the authority of the plan administrator with respect thereto, including the authority to amend such awards) shall remain outstanding in accordance with their applicable terms and conditions and the terms and conditions of the YS Biopharma 2022 Plan.

Termination and amendment. Unless terminated earlier, the YS Biopharma 2022 Plan has a term of 10 years, effective from the date of approval by the shareholders. The board of directors of YS Biopharma has the authority to amend or terminate the plan. To the extent required by applicable law or any applicable listing agency or required under the Internal Revenue Code of 1986 or deemed necessary or advisable by the board of directors, the amendment this plan shall be subject to the shareholders' approval. However, no such action may adversely affect in any material way any awards previously granted without the prior written consent of the recipient.

As of the date of this prospectus, under the YS Biopharma 2022 Plan, 6,656,582 Ordinary Shares are reserved but not issued, subject to certain adjustment.

The following table sets forth the number of options granted and outstanding under the YS Biopharma 2022 Plan as of the date of this prospectus:

Name of Grantee	Ordinary Shares Options Awarded	Exercise Price Per Ordinary Share (\$)	Grant Date	Expiration Date
Mr. Yi Zhang	1,037,549	2.1956 – 8.276	December 31, 2020	December 30, 2030
Ms. Chunyuan Wu	255,190	4.0724 – 8.276	December 31, 2020	December 30, 2030
Dr. Yuan Liu	23,811	4.0724 – 8.276	December 31, 2020	December 30, 2030
Mr. Gang Li	10,965	4.0724 – 8.276	December 31, 2020	December 30, 2030
Other over 450 employees	2,144,031	4.0724 – 8.276	December 31, 2020	December 30, 2030

BENEFICIAL OWNERSHIP OF SECURITIES

The following table sets forth information regarding the beneficial ownership of our Ordinary Shares as of January 23, 2024:

- each person known by us to beneficially own 5.0% or more of the outstanding Ordinary Shares;
- each executive officer or director of YS Biopharma; and
- all the executive officers and directors of YS Biopharma as a group.

Beneficial ownership is determined in accordance with the rules of the SEC and includes voting or investment power with respect to, or the power to receive the economic benefit of ownership of, the securities. In computing the number of shares beneficially owned by a person and the percentage ownership of that person, shares that the person has the right to acquire within 60 days are included, including through the exercise of any option or other right or the conversion of any other security. However, these shares are not included in the computation of the percentage ownership of any other person.

The beneficial ownership percentages set forth in the table below have been determined based on 93,058,197 Ordinary Shares issued and outstanding as of January 23, 2024.

	Number	%
Directors and Executive Officers⁽¹⁾:		
Mr. Yi Zhang ⁽²⁾	49,089,185	52.75%
Dr. Hui Shao ⁽³⁾	2,048,780	2.20%
Mr. Bo Tan ⁽⁴⁾	3,853,475	4.14%
Dr. Ajit Shetty	*	*
Dr. Viren Mehta	*	*
Ms. Rui Yu	—	
Mr. Shaojing Tong	—	
Dr. Zenaída Reynoso Mojares	—	
Ms. Chunyuan Wu	*	*
Dr. Yuan Liu	—	
Mr. Gang Li	—	
All Directors and Executive Officers as a Group	54,858,366	58.95%
Principal Shareholders:		
Mr. Yi Zhang and his affiliated entities ⁽²⁾	48,615,000	52.24%

* Less than 1%.

- (1) The business address of YS Biopharma’s directors and executive officers is Building No. 2, 38 Yongda Road, Daxing Biomedical Industry Park, Daxing District, Beijing, PRC.
- (2) Represents (1) 38,972,000 ordinary shares held by All Brilliance Investments Limited, a limited liability company incorporated under the laws of British Virgin Islands and being wholly-controlled by Mr. Zhang; (2) 4,571,500 ordinary shares held by Hopeful World Company Limited, a limited liability company incorporated under the laws of British Virgin Islands and being wholly-controlled by Ms. Rui Mi, the spouse of Mr. Yi Zhang; (3) 2,435,750 ordinary shares held by Acton Town International Limited, a limited liability company incorporated under the laws of British Virgin Islands and being held wholly-controlled by Ms. Nan Zhang, a daughter of Mr. Yi Zhang; (4) 2,435,750 ordinary shares held by Apex Pride Global Limited, a limited liability company incorporated under the laws of British Virgin Islands and being held wholly-controlled by Ms. Xu Zhang, a daughter of Mr. Yi Zhang; (5) 629,188 ordinary shares directly held by Mr. Yi Zhang. Mr. Yi Zhang and his aforementioned affiliates have entered into an acting-in-concert agreement to act in concert with Mr. Yi Zhang; (6) 13,339 ordinary shares directly held by Ms. Nan Zhang; and (7) 31,658 ordinary shares directly held by Ms. Xu Zhang. See “Major Shareholders and Related Party Transactions — Concert Party Agreement” and “Summary of the Prospectus — Overview” for details. The registered address of All Brilliance Investments Limited is Wickhams Cay II, Road Town, Tortola, VG1110, British Virgin Islands. All the registered addresses of Hopeful World Company Limited, Acton Town International and Apex Pride Global Limited are Portcullis TrustNet Chambers, P.O. Box 3444, Road Town, Tortola, British Virgin Islands.

[Table of Contents](#)

- (3) Represents (1) 1,802,780 ordinary shares held by Mountainview Investment Holdings LLC, a limited liability company incorporated under the laws of the State of Delaware and being wholly-controlled by Mr. Hui Shao; (2) 200,000 ordinary shares directly held by Mr. Hui Shao; and (3) 46,300 ordinary shares from on-market purchase. The business address of Mountainview Investment Holdings LLC is 8 The Green, Suite B, Dover, Delaware 19901, USA.
- (4) The shares reported are held in the name of the Sponsor. Mr. Bo Tan is one of the three managers of the Sponsor. The managers have voting and investment discretion with respect to the ordinary shares held of record by the Sponsor. Each of the managers of the Sponsor disclaims any beneficial ownership of the securities held by the Sponsor other than to the extent of any pecuniary interest they may have therein, directly or indirectly.

SELLING SECURITYHOLDERS

This prospectus relates to the possible offer and sale from time to time by the Selling Securityholders of up to 24,130,762 Ordinary Shares.

The Selling Securityholders may from time to time offer and sell any or all of the securities set forth below pursuant to this prospectus. When we refer to the “Selling Securityholders” in this prospectus, we mean the persons listed in the tables below, and the pledgees, donees, transferees, assignees, successors and others who later come to hold any of the Selling Securityholders’ interest in our securities after the date of this prospectus.

The table below sets forth, as of the date of this prospectus, the name of the Selling Securityholders for which we are registering securities for resale to the public and the aggregate principal amount that the Selling Securityholders may offer pursuant to this prospectus. The individuals and entities listed below have beneficial ownership over their respective securities. The SEC has defined “beneficial ownership” of a security to mean the possession, directly or indirectly, of voting power and/or investment power over such security. A shareholder is also deemed to be, as of any date, the beneficial owner of all securities that such shareholder has the right to acquire within 60 days after that date through (1) the exercise of any option, warrant or right, (2) the conversion of a security, (3) the power to revoke a trust, discretionary account or similar arrangement, or (4) the automatic termination of a trust, discretionary account or similar arrangement. In computing the number of shares beneficially owned by a person and the percentage ownership of that person, ordinary shares subject to options or other rights (as set forth above) held by that person that are currently exercisable, or will become exercisable within 60 days thereafter, are deemed outstanding, while such shares are not deemed outstanding for purposes of computing percentage ownership of any other person.

The securities held by certain of the Selling Securityholders are subject to transfer restrictions, as described in “Description of Share Capital — Transfer of Ordinary Shares.”

We cannot advise you as to whether the Selling Securityholders will in fact sell any or all of such securities. In addition, the Selling Securityholders may sell, transfer or otherwise dispose of, at any time and from time to time, the ordinary shares in transactions exempt from the registration requirements of the Securities Act after the date of this prospectus, subject to applicable law.

Selling Securityholder information for each additional Selling Securityholder, if any, will be set forth by prospectus supplement to the extent required prior to the time of any offer or sale of such Selling Securityholder’s securities pursuant to this prospectus. Any prospectus supplement may add, update, substitute, or change the information contained in this prospectus, including the identity of each Selling Securityholder and the number of Ordinary Shares registered on its behalf. A Selling Securityholder may sell all, some or none of such securities in this offering. See the section titled “Plan of Distribution.”

The securities owned by the persons named below do not have voting rights different from the securities owned by other holders.

Name of Selling Securityholder	Securities beneficially owned prior to this offering		Securities to be sold in this offering	Securities beneficially owned after this offering	
	Ordinary Shares	% ⁽¹⁾	Ordinary Shares	Ordinary Shares ⁽¹⁾⁽²⁾	% ⁽¹⁾⁽²⁾
Hui Shao ⁽³⁾	2,002,780	2.2%	2,002,780	—	—
Chunyuan Wu ⁽⁴⁾	97,500	*	97,500	—	—
Sunangal Ajit Shetty & Christine Maria M. Clerinx ⁽⁵⁾	27,500	*	27,500	—	—
Viren T MEHTA & Amita RODMAN (as Trustees of V Mehta RLT & A Rodman RLT) ⁽⁶⁾	35,000	*	35,000	—	—
Stanley Yi Chang ⁽⁷⁾	82,111	*	82,111	—	—
Viren T Mehta ⁽⁸⁾	72,500	*	72,500	—	—
Sunangal Ajit Shetty ⁽⁹⁾	72,500	*	72,500	—	—
Asia Ventures II L.P. ⁽¹⁰⁾	2,718,499	2.9%	2,718,499	—	—

[Table of Contents](#)

Name of Selling Securityholder	Securities beneficially owned prior to this offering		Securities to be sold in this offering	Securities beneficially owned after this offering	
	Ordinary Shares	% ⁽¹⁾	Ordinary Shares	Ordinary Shares ⁽¹⁾⁽²⁾	% ⁽¹⁾⁽²⁾
F-Prime Capital Partners Healthcare Fund III LP ⁽¹¹⁾	1,165,071	1.3%	1,165,071	—	—
HH SUM XXXVI Holdings Limited ⁽¹²⁾	751,790	*	751,790	—	—
Entities affiliated with OrbiMed ⁽¹³⁾	4,298,465	4.6%	4,298,465	—	—
Haitong Xu Yu International Limited ⁽¹⁴⁾	187,948	*	187,948	—	—
Epiphron Capital (Hong Kong) Limited ⁽¹⁵⁾	701,148	*	701,148	—	—
3W Global Investment Limited ⁽¹⁶⁾	187,948	*	187,948	—	—
Oceanpine Investment Fund II LP ⁽¹⁷⁾	4,105,596	4.4%	4,105,596	—	—
AIHC Master Fund ⁽¹⁸⁾	718,480	*	718,480	—	—
3W Global Fund ⁽¹⁹⁾	2,052,798	2.2%	2,052,798	—	—
MSA China Growth Fund II L.P. ⁽²⁰⁾	1,129,039	1.2%	1,129,039	—	—
Superstring Capital Master Fund LP ⁽²¹⁾	307,920	*	307,920	—	—
Wudaokou Capital Limited ⁽²²⁾	307,920	*	307,920	—	—
Gennex China Growth Fund ⁽²³⁾	205,280	*	205,280	—	—
Adjuvant Global Health Technology Fund, L.P. ⁽²⁴⁾	2,436,298	2.6%	2,436,298	—	—
Adjuvant Global Health Technology Fund DE, L.P. ⁽²⁴⁾	466,671	*	466,671	—	—

* Less than 1% of the total number of outstanding Ordinary Shares.

- (1) The percentage of our Ordinary Shares beneficially owned is computed on the 93,058,197 Ordinary Shares issued and outstanding as of the date of this prospectus, and does not include 16,750,000 Ordinary Shares issuable upon the exercise of our Warrants.
- (2) Assumes the sale of all shares offered in this prospectus.
- (3) Represents (i) 1,802,780 ordinary shares held by Mountainview Investment Holdings LLC, a limited liability company incorporated under the laws of the State of Delaware and wholly-controlled by Mr. Hui Shao; (ii) 200,000 ordinary shares directly held by Mr. Hui Shao; and (3) 46,300 ordinary shares from on-market purchase. The business address of Mountainview Investment Holdings LLC is 8 The Green, Suite B, Dover, Delaware 19901, USA. The business address of Hui Shao is Building No. 2, 38 Yongda Road Daxing Biomedical Industry Park, Daxing District, Beijing, PRC.
- (4) The business address of Chunyuan Wu is Building No. 2, 38 Yongda Road Daxing Biomedical Industry Park, Daxing District, Beijing, PRC.
- (5) The business address of Sunangal Ajit Shetty & Christine Maria M. Clerinx is Building No. 2, 38 Yongda Road Daxing Biomedical Industry Park, Daxing District, Beijing, PRC.
- (6) The business address of Viren T MEHTA & Amita RODMAN (as Trustees of V Mehta RLT & A Rodman RLT), is Building No. 2, 38 Yongda Road Daxing Biomedical Industry Park, Daxing District, Beijing, PRC.
- (7) The business address of Stanley Yi Chang is Building No. 2, 38 Yongda Road Daxing Biomedical Industry Park, Daxing District, Beijing, PRC.
- (8) The business address of Viren T Mehta is Building No. 2, 38 Yongda Road Daxing Biomedical Industry Park, Daxing District, Beijing, PRC.
- (9) The business address of Sunangal Ajit Shetty is Building No. 2, 38 Yongda Road Daxing Biomedical Industry Park, Daxing District, Beijing, PRC.
- (10) The business address of Asia Ventures II L.P. is Pembroke Hall, 42 Crow Lane, Pembroke, HM19, Bermuda.
- (11) The business address of F-Prime Capital Partners Healthcare Fund III LP is Corporation Trust Center, 1209 Orange Street in the city of Wilmington, ZIP Code 19801, United States of America.
- (12) The business address of HH SUM XXXVI Holdings Limited is 89 Nexus Way, Camana Bay, P.O. Box 31106, Grand Cayman KY1-1205, Cayman Islands.

Table of Contents

- (13) Represents (i) 2,104,054 Ordinary Shares held by The Biotech Growth Trust PLC (“BIOG”); (ii) 701,352 Ordinary Shares held by OrbiMed Genesis Master Fund, L.P. (“Genesis”); (iii) 889,300 Ordinary Shares held by OrbiMed New Horizons Master Fund, L.P. (“ONH”); (iv) 506,428 Ordinary Shares held by OrbiMed Partners Master Fund Limited (“OPM”); and (v) 97,331 Ordinary Shares held by OrbiMed Partners SPV, Ltd. (“OPM SPV”). OrbiMed Advisors LLC (“OrbiMed Advisors”), a registered investment advisors under the Investment Advisors Act of 1940, as amended, is the investment manager of Genesis and ONH. OrbiMed Capital LLC (“OrbiMed Capital”) is the portfolio manager of BIOG and the investment manager of OPM and OPM SPV. OrbiMed Capital is a relying advisor of OrbiMed Advisors. OrbiMed Advisors and OrbiMed Capital exercise voting and investment power through a management committee comprised of Carl L. Gordon, Sven H. Borho, and W. Carter Neild, each of whom disclaims beneficial ownership of the shares held by BIOG, Genesis, ONH, OPM, and OPM SPV. The business address of these entities is c/o OrbiMed Advisors LLC, 601 Lexington Avenue, 5th Floor, New York, NY 10022.
- (14) The business address of Haitong Xu Yu International Limited is Setus Chambers, P.O. Box 905, Quastisky Building, Road Town, British Virgin Islands.
- (15) The business address of Epiphron Capital (Hong Kong) Limited is Room 15, Unit B, 14/F, Win Sun Factory Building, 2 San Hop Lane, Tuen Mun, N.T., Hong Kong.
- (16) The business address of 3W Global Investment Limited is Vistra Corporate Services Centre, Wickhams Cay II, Road Town, Tortola, VG1110, British Virgin Islands.
- (17) The business address of Oceanpine Investment Fund II LP is PO Box 309, Uglan House, Grand Cayman, KY1-1104, Cayman Islands.
- (18) The business address of AIHC Master Fund is PO Box 309, Uglan House, Grand Cayman, KY1-1104, Cayman Islands.
- (19) The business address of 3W Global Fund is Suite 507, ICBC Tower, 3 Garden Road, Central, Hong Kong.
- (20) The business address of MSA China Growth Fund II L.P. is 89 Nexus Way, Camana Bay, Grand Cayman KY1 -9009, Cayman Islands.
- (21) The business address of Superstring Capital Master Fund LP is PO Box 309, Uglan House, Grand Cayman, KY1-1104, Cayman Islands.
- (22) The business address of Wudaokou Capital Limited is 29 Qingfengxi Street, Daxing District Biomedical Base, Beijing, China.
- (23) The business address of Gennex China Growth Fund is Floor 4, Willow House, Cricket Square, Grand Cayman, KY1-9010, Cayman Islands.
- (24) The business address of Adjuvant Global Health Technology Fund, L.P. and Adjuvant Global Health Technology Fund DE, L.P. is 500 Fifth Avenue, Suite 5120, New York, NY 10110, United States of America.

Material Relationships with Selling Securityholders

See “Major Shareholders and Related Party Transactions.”

MAJOR SHAREHOLDERS AND RELATED PARTY TRANSACTIONS**Shareholders Support Agreement**

See “Shares Eligible for Future Sale.”

Employment Agreements and Indemnification Agreements

See “Management — Employment Agreements and Indemnification Agreements.”

Share Incentive Plans

See “Management — Share Incentive Plans.”

Other Related Party Transactions

	Fiscal Year Ended March 31,			Six Months Ended September 30,		
	2021	2022	2023	2023	2023	2023
	(RMB)	(RMB)	(RMB)	(\$)	(RMB)	(\$)
Amounts due from related party:						
Yisheng Biopharma Holdings Limited (Hong Kong)						
Receivable collected on behalf of YS Group	30,088,833	2,966,777	—	—	—	—
Repayment to YS Group	—	33,055,610	—	—	—	—

In fiscal 2021, YS Biopharma lent RMB30,088,833 to Yisheng Biopharma Holdings Limited (Hong Kong) for its operating needs. In fiscal 2022, YS Group lent another RMB2,966,777 to Yisheng Biopharma Holdings Limited (Hong Kong), and Yisheng Biopharma Holdings Limited (Hong Kong) repaid RMB33,055,610 in full to YS Group. As of September 30, 2023, the balance of amount due from Yisheng Biopharma Holdings Limited (Hong Kong) was nil.

In July 2023, YS Group spent US\$20,000 to purchase a vehicle from Ms. Ruimi, spouse of Mr. Yi Zhang.

From time to time, and prior to the business reorganization that completed in February 2021, YS Biopharma borrowed or lent money to or form the following related parties that were under common control of Mr. Zhang for working capital purposes:

Concert Party Agreement

Yi Zhang and the entities controlled by Yi Zhang, including (1) An Diang Group Holdings Limited, YXRT Company Limited and All Brilliance Investments Limited; (2) Rui Mi and the entities controlled by Rui Mi, including Honeydrew Flower Field Ltd., ZM Home Limited and Hopeful World Company Limited; (3) Xu Zhang and the entities controlled by Xu Zhang, including Apex Pride Global Limited, Prosperous Sunrise Company Limited and Much Galaxy Company Limited; and (4) Nan Zhang and the entities controlled by Nan Zhang, including Spring Nanmu Islands Ltd., NNZF Company Limited and Acton Town International Limited (the “Concert Parties”) entered into the Concert Party Agreement, pursuant to which, the Concert Parties agree and acknowledge that they have voted since commencement of YS Group’s business, and will continue to vote, themselves or through any entity directly or indirectly controlled by them that own YS Biopharma’s equity interest, unanimously for any resolutions proposed at the board meetings and/or shareholders meeting of YS Biopharma, where applicable. According to the Concert Party Agreement, if the Concert Parties are unable to reach unanimous consensus, Yi Zhang is entitled to determine how to vote for and on behalf of himself and the Concert Parties. The Concert Agreement remains effective unless otherwise terminated by mutual consent of the Concert Parties.

DESCRIPTION OF YS BIOPHARMA'S SECURITIES

A summary of the material provisions governing YS Biopharma's share capital is described below. This summary is not complete and should be read together with the Amended YS Biopharma Articles, a copy of which is included elsewhere in this registration statement.

YS Biopharma is a Cayman Islands exempted company with limited liability and is governed by the Amended YS Biopharma Articles, the Cayman Islands Companies Act, and the common law of the Cayman Islands.

YS Biopharma's authorized share capital is \$50,000 divided into 2,500,000,000 ordinary shares of \$0.00002 par value each. All Ordinary Shares issued and outstanding were fully paid and non-assessable.

The following are summaries of material provisions of the Amended YS Biopharma Articles and the Cayman Islands Companies Act insofar as they relate to the material terms of the Ordinary Shares.

Ordinary Shares

General

Holders of Ordinary Shares have the same rights. All of the Ordinary Shares are fully paid and non-assessable. Shareholders of YS Biopharma who are non-residents of the Cayman Islands may freely hold and transfer their ordinary shares.

Dividends

The holders of Ordinary Shares are entitled to such dividends as may be declared by the board of directors of YS Biopharma. In addition, YS Biopharma shareholders may declare dividends by ordinary resolution, but no dividend shall exceed the amount recommended by the board of directors of YS Biopharma. The Amended YS Biopharma Articles provide that the directors of YS Biopharma may, before recommending or declaring any dividend, set aside out of the funds legally available for distribution such sums as they think proper as a reserve or reserves which shall, in the absolute discretion of the directors, be applicable for meeting contingencies or for equalizing dividends or for any other purpose to which those funds may be properly applied. Under the laws of the Cayman Islands, YS Biopharma may pay a dividend out of either profit or share premium account, provided that in no circumstances may a dividend be paid if this would result in YS Biopharma being unable to pay its debts as they fall due in the ordinary course of business.

Voting Rights

In respect of all matters subject to a shareholders' vote, each ordinary share is entitled to one vote. Voting at any meeting of shareholders is by show of hands unless a poll is (before or on the declaration of the result of the show of hands) demanded. A poll may be demanded by the chairperson of such meeting or any one or more shareholders holding not less than ten per cent (10%) of the votes attaching to the Ordinary Shares present in person or by proxy and entitled to vote. An ordinary resolution to be passed at a meeting by the shareholders requires the affirmative vote of a simple majority of the votes attaching to the ordinary shares cast at a meeting, while a special resolution requires the affirmative vote of no less than two-thirds of the votes cast attaching to the issued and outstanding ordinary shares at a meeting and includes a unanimous written resolution. A special resolution will be required for important matters such as a change of name, reducing the share capital or making changes to the Amended YS Biopharma Articles.

Transfer of Ordinary Shares

Subject to the restrictions contained in the Amended YS Biopharma Articles, any of YS Biopharma shareholders may transfer all or any of his or her ordinary shares by an instrument of transfer in the usual or common form or any other form approved by YS Biopharma's Board of directors.

Table of Contents

YS Biopharma's Board of directors may, in its absolute discretion, decline to register any transfer of any ordinary share which is not fully paid up or on which there is a lien. YS Biopharma's Board of directors may also decline to register any transfer of any ordinary share unless:

- the instrument of transfer is lodged with YS Biopharma, accompanied by the certificate for the shares to which it relates (if any) and such other evidence as the board of directors of YS Biopharma may reasonably require to show the right of the transferor to make the transfer;
- the instrument of transfer is in respect of only one class of shares;
- the instrument of transfer is properly stamped, if required;
- in the case of a transfer to joint holders, the number of joint holders to whom the share is to be transferred does not exceed four; or
- a fee of such maximum sum as Nasdaq may determine to be payable, or such lesser sum as the board of directors of YS Biopharma may from time to time require, is paid to YS Biopharma in respect thereof.

If YS Biopharma's directors refuse to register a transfer, they shall, within three calendar months after the date on which the instrument of transfer was lodged with YS Biopharma, send to each of the transferor and the transferee notice of such refusal.

The registration of transfers may, on ten calendar days' notice being given by advertisement in such one or more newspapers, by electronic means or by any other means in accordance with Nasdaq Rules, be suspended and the register of members closed at such times and for such periods as the board of directors may, in their absolute discretion, from time to time determine, provided, always that the registration of transfers shall not be suspended nor the register of members closed for more than 30 days in any calendar year.

Liquidation

If YS Biopharma is wound up, and the assets available for distribution among the holders of ordinary shares shall be more than sufficient to repay the whole of the share capital at the commencement of the winding up, the surplus shall be distributed amongst YS Biopharma's shareholders in proportion to the par value of the Ordinary Shares held by them at the commencement of the winding up subject to a deduction from those Ordinary Shares in respect of which there are monies due, of all monies payable to YS Biopharma for unpaid calls or otherwise. If its assets available for distribution are insufficient to repay all of the whole of the share capital, such assets shall be distributed so that as nearly as may be, the losses shall be borne by YS Biopharma's shareholders in proportion to the par value of the Ordinary Shares held by them.

Calls on Ordinary Shares and Forfeiture of Ordinary Shares

The directors of YS Biopharma may from time to time make calls upon shareholders for any amounts unpaid on their Ordinary Shares (subject to receiving at least fourteen calendar days' notice specifying the time or times of payment). The sum called in respect of Ordinary Shares that remain unpaid are, after a notice period given pursuant to the provision of the Amended YS Biopharma Articles, subject to forfeiture.

Redemption of Ordinary Shares

Subject to the provisions of the Cayman Islands Companies Act, YS Biopharma may issue shares that are to be redeemed or are liable to be redeemed at the option of the shareholder or YS Biopharma. The redemption of such shares will be affected in such manner and upon such other terms as YS Biopharma may, by either resolution of the board of directors of YS Biopharma or special resolution of shareholders, determine before the issue of such shares. YS Biopharma may also repurchase any Ordinary Shares (including any redeemable shares) on such terms and in such manner as have been approved by the board of directors of YS Biopharma or by an ordinary resolution of YS Biopharma's shareholders.

Under the Cayman Islands Companies Act, the redemption or repurchase of any share may be paid out of the company's profits or out of the proceeds of a fresh issue of shares made for the purpose of such redemption or repurchase, or out of capital (including share premium account and capital redemption reserve) if the company can,

[Table of Contents](#)

immediately following such payment, pay its debts as they fall due in the ordinary course of business. In addition, under the Companies Act, no such share may be redeemed or repurchased (i) unless it is fully paid up, (ii) if such redemption or repurchase would result in there being no shares issued and outstanding, or (iii) if the company has commenced liquidation. In addition, YS Biopharma's directors may accept the surrender of any fully paid share for no consideration.

Variation of Rights of Shares

Under the Delaware General Corporation Law, a corporation may vary the rights of a class of shares with the approval of majority of the outstanding shares of such class, unless the certificate of incorporation provides otherwise. Under the Amended YS Biopharma Articles, if at any time, YS Biopharma's share capital is divided into different classes of shares, the rights attached to any class of shares may, subject to any rights or restrictions for the time being attached to any class, only be materially adversely varied with the consent in writing of the holders of two-thirds of the issued shares of that class or with the sanction of a special resolution passed at a separate general meeting of the holders of the shares of that class. The rights conferred upon the holders of the shares of any class issued with preferred or other rights shall not, subject to any rights or restrictions for the time being attached to the shares of that class, be deemed to be materially adversely varied by, inter alia, the creation, allotment or issue of further shares ranking pari passu with or subsequent to them or the redemption or purchase of any shares of any class by the company. The rights of the holders of Ordinary Shares shall not be deemed to be materially adversely varied by the creation or issue of shares with preferred or other rights including, without limitation, the creation of shares with enhanced or weighted voting rights.

General Meetings of Shareholders

Shareholders' meetings may be convened by the chairperson of YS Biopharma a majority of YS Biopharma's board of directors. Advance notice of at least seven (7) calendar days is required for the convening of its annual general shareholders' meeting and any other general meeting of its shareholders, provided that a general meeting of the Company shall be deemed to have been duly convened if it is so agreed by two-thirds of the shareholders (or their proxies) having a right to attend and vote at the meeting, present at the meeting.

The Companies Act provides shareholders with only limited rights to requisition a general meeting and does not provide shareholders with any right to put any proposal before a general meeting. However, these rights may be provided in a company's articles of association. The Amended YS Biopharma Articles provide that upon the requisition of shareholders representing in aggregate not less than 10% of all votes attaching to YS Biopharma's issued and outstanding shares entitled to vote at general meetings as at the date of the deposit of the requisition, YS Biopharma's board is obliged to convene an extraordinary general meeting and put the resolutions so requisitioned to a vote at such meeting. However, the Amended YS Biopharma Articles do not provide YS Biopharma's shareholders with any right to put any proposals before annual general meetings or extraordinary general meetings not called by such shareholders.

Voting Rights Attaching to the Shares.

Subject to any rights and restrictions for the time being attached to any Share, on a show of hands every shareholder present in person and every person representing a shareholder by proxy shall, at a shareholders' meeting, each have one vote and on a poll every shareholder and every person representing a shareholder by proxy shall have one vote for each Share of which he or the person represented by proxy is the holder.

Inspection of Books and Records

Subject to the relevant laws, rules and regulations applicable to YS Biopharma, no shareholder shall be entitled to require discovery of any information in respect of any detail of the company's trading or any information which is or may be in the nature of a trade secret or secret process which may relate to the conduct of the business of the company and which in the opinion of the board of directors of YS Biopharma would not be in the interests of the shareholders of the company to communicate to the public.

The board of directors of YS Biopharma will determine whether, to what extent, at what times and places and under what conditions the accounts and books of YS Biopharma will be open to inspection by YS Biopharma shareholders, and no YS Biopharma shareholder (not being a director of YS Biopharma) will otherwise have any right of inspecting

[Table of Contents](#)

any account or book or document of YS Biopharma except as required by the Cayman Islands Companies Act, or as authorized by its board of directors or by an ordinary resolution of its shareholders. Holders of YS Biopharma's ordinary shares have no general right under Cayman Islands law to inspect or obtain copies of its list of shareholders or YS Biopharma's corporate records (except for its memorandum and articles of association, its register of mortgages and charges and special resolutions of YS Biopharma's shareholders).

Changes in Capital

YS Biopharma may from time to time by ordinary resolution:

- increase its share capital by such sum, to be divided into shares of such amount, as the resolution will prescribe;
- consolidate and divide all or any of its share capital into shares of a larger amount than existing shares;
- sub-divide its existing shares or any of them into shares of a smaller amount; provided that in the subdivision the proportion between the amount paid and the amount, if any, unpaid on each reduced share will be the same as it was in case of the share from which the reduced share is derived; or
- cancel any shares that at the date of the passing of the resolution have not been taken or agreed to be taken by any person and diminish the amount of its share capital by the amount of the shares so cancelled.

YS Biopharma may by special resolution, subject to any confirmation or consent required by the Cayman Islands Companies Act, reduce its share capital or any capital redemption reserve in any manner permitted by law.

Warrants

Upon the consummation of the Business Combination, each Summit Warrant outstanding immediately prior has ceased to be a warrant with respect to Summit Public Shares and be assumed by YS Biopharma and converted into a YS Biopharma Warrant entitling the holder thereof to purchase such number of Ordinary Share on a one-on-one basis. Each YS Biopharma Warrant will otherwise continue to have and be subject to substantially the same terms and conditions as were applicable to such Summit Warrant immediately prior to the consummation of the Business Combination (including any repurchase rights and cashless exercise provisions).

Exempted Company

YS Biopharma is an exempted company with limited liability incorporated under the laws of Cayman Islands. The Cayman Islands Companies Act distinguishes between ordinary resident companies and exempted companies. Any company that is registered in the Cayman Islands but conducts business mainly outside of the Cayman Islands may apply to be registered as an exempted company. The requirements for an exempted company are essentially the same as for an ordinary resident company except for the exemptions and privileges listed below:

- an exempted company (other than an exempted company holding a license to carry on business in the Cayman Islands) does not have to file an annual return of its shareholders with the Registrar of Companies of the Cayman Islands;
- an exempted company's register of members is not open to inspection;
- an exempted company does not have to hold an annual general meeting;
- an exempted company may not issue negotiable or bearer shares, but may issue shares with no par value;
- an exempted company may obtain an undertaking against the imposition of any future taxation;
- an exempted company may register by way of continuation in another jurisdiction and be deregistered in the Cayman Islands;
- an exempted company may register as a limited duration company; and
- an exempted company may register as a segregated portfolio company.

[Table of Contents](#)

“Limited liability” means that the liability of each shareholder is limited to the amount unpaid by the shareholder on the shares of the company (except in exceptional circumstances, such as involving fraud, the establishment of an agency relationship or an illegal or improper purpose or other circumstances in which a court may be prepared to pierce or lift the corporate veil).

Data Protection in the Cayman Islands — Privacy Notice

This privacy notice explains the manner in which YS Biopharma collects, processes and maintains personal data about investors of the company pursuant to the Data Protection Act, 2017 of the Cayman Islands, as amended from time to time and any regulations, codes of practice or orders promulgated pursuant thereto (“DPA”).

YS Biopharma is committed to processing personal data in accordance with the DPA. In its use of personal data, the company will be characterized under the DPA as a ‘data controller’, whilst certain of the company’s service providers, affiliates and delegates may act as ‘data processors’ under the DPA. These service providers may process personal information for their own lawful purposes in connection with services provided to the company.

This privacy notice puts shareholders of YS Biopharma on notice that, by virtue of making an investment in YS Biopharma, YS Biopharma and certain of service providers of YS Biopharma may collect, record, store, transfer and otherwise process personal data by which individuals may be directly or indirectly identified.

Your personal data will be processed fairly and for lawful purposes, including (a) where the processing is necessary for the company to perform a contract to which you are a party or for taking pre-contractual steps at your request (b) where the processing is necessary for compliance with any legal, tax or regulatory obligation to which the company is subject or (c) where the processing is for the purposes of legitimate interests pursued by the company or by a service provider to whom the data are disclosed. As a data controller, YS Biopharma will only use your personal data for the purposes for which YS Biopharma collected it. If YS Biopharma needs to use your personal data for an unrelated purpose, YS Biopharma will contact you.

YS Biopharma anticipate that YS Biopharma will share your personal data with the company’s service providers for the purposes set out in this privacy notice. YS Biopharma may also share relevant personal data where it is lawful to do so and necessary to comply with its contractual obligations or your instructions or where it is necessary or desirable to do so in connection with any regulatory reporting obligations. In exceptional circumstances, YS Biopharma will share your personal data with regulatory, prosecuting and other governmental agencies or departments, and parties to litigation (whether pending or threatened), in any country or territory including to any other person where YS Biopharma have a public or legal duty to do so (e.g., to assist with detecting and preventing fraud, tax evasion and financial crime or compliance with a court order).

Your personal data shall not be held by YS Biopharma for longer than necessary with regard to the purposes of the data processing.

YS Biopharma will not sell your personal data. Any transfer of personal data outside of the Cayman Islands shall be in accordance with the requirements of the DPA. Where necessary, YS Biopharma will ensure that separate and appropriate legal agreements are put in place with the recipient of that data.

YS Biopharma will only transfer personal data in accordance with the requirements of the DPA, and will apply appropriate technical and organizational information security measures designed to protect against unauthorized or unlawful processing of the personal data and against the accidental loss, destruction or damage to the personal data.

If you are a natural person, this will affect you directly. If you are a corporate investor (including, for these purposes, legal arrangements such as trusts or exempted limited partnerships) that provides YS Biopharma with personal data on individuals connected to you for any reason in relation to your investment into the company, this will be relevant for those individuals and you should inform such individuals of the content.

You have certain rights under the DPA, including (a) the right to be informed as to how YS Biopharma collect and use your personal data (and this privacy notice fulfils YS Biopharma’s obligation in this respect) (b) the right to obtain a copy of your personal data (c) the right to require YS Biopharma to stop direct marketing (d) the right to have inaccurate or incomplete personal data corrected (e) the right to withdraw your consent and require YS Biopharma to stop processing or restrict the processing, or not begin the processing of your personal data (f) the right to be notified of a data breach (unless the breach is unlikely to be prejudicial) (g) the right to obtain information as to any countries

[Table of Contents](#)

or territories outside the Cayman Islands to which YS Biopharma, whether directly or indirectly, transfer, intend to transfer or wish to transfer your personal data, general measures YS Biopharma take to ensure the security of personal data and any information available to YS Biopharma as to the source of your personal data (h) the right to complain to the Office of the Ombudsman of the Cayman Islands and (i) the right to require YS Biopharma to delete your personal data in some limited circumstances.

If you consider that your personal data has not been handled correctly, or you are not satisfied with the company's responses to any requests you have made regarding the use of your personal data, you have the right to complain to the Cayman Islands' Ombudsman. The Ombudsman can be contacted by calling +1 (345) 946-6283 or by email at info@ombudsman.ky.

Registration Rights

Certain persons who hold YS Biopharma securities are entitled to customary demand and piggyback registration rights. YS Biopharma also agrees to file a registration statement on Form F-1 within 20 days after the Closing (or 60 days if additional financial information is required) to register the registrable securities pursuant to YS Biopharma's shareholders agreement.

SHARES ELIGIBLE FOR FUTURE SALE

YS Biopharma had 93,058,197 Ordinary Shares issued and outstanding as of January 23, 2024. All of the Ordinary Shares issued to the Summit Shareholders in connection with the Business Combination are freely transferable by persons other than by the Sponsor and YS Biopharma's affiliates without restriction or further registration under the Securities Act. In addition, Ordinary Shares and Warrants held by certain shareholders are subject to lock-up restrictions described below. Sales of substantial amounts of the Ordinary Shares in the public market could adversely affect prevailing market price of the Ordinary Shares.

Lock-up Arrangements

Concurrently with the execution of the Business Combination Agreement, Summit and YS Biopharma agree, pursuant to the Shareholder Support Agreement, to cause the Sponsor and the independent directors of Summit (together with the Sponsor, the "SPAC Insiders") and all pre-Closing shareholders of YS Biopharma (together with the SPAC Insiders, the "YS Biopharma Lock-Up Shareholders") to be subject to certain lock-up restrictions as provided therein, effective as of the First Merger Effective Time, pursuant to which, any Ordinary Shares held by such YS Biopharma Lock-Up Shareholder immediately after the First Merger Effective Time (such Ordinary Shares, collectively, the "YS Biopharma Lock-Up Shares") shall not be transferred during the applicable lock-up period, subject to customary exceptions. For each YS Biopharma Lock-Up Shareholder who is not a SPAC Insider, the applicable lock-up period will be 180 days from and after the First Merger Effective Time. For each YS Biopharma Lock-Up Shareholder who is a SPAC Insider, the applicable lock-up period will be 12 months from and after the First Merger Effective Time. The lock-up requirements will cease to apply after the date on which the closing price of the Ordinary Shares equals or exceeds \$12.00 per share for any 20 trading days within any 30 trading day period commencing at least 150 days after the First Merger Effective Time. YS Biopharma may release, (1) in its sole discretion, up to 3,000,000 YS Biopharma Lock-Up Shares and (2) with prior written consent from Summit and the Sponsor, an additional number of YS Biopharma Lock-Up Shares to the extent necessary to satisfy the minimum public float requirement as required for obtaining Nasdaq's listing approval, provided that a release pursuant to sub-clauses (1) and (2) shall apply on a pro rata basis to all YS Biopharma Lock-Up Shares held by YS Biopharma Lock-Up Shareholders who are holders of preferred shares of YS Biopharma (and ordinary shares issued upon conversion thereof) immediately prior to the First Merger Effective Time.

Registration Rights

Concurrently with the execution of the Business Combination Agreement, pursuant to the Shareholder Support Agreement, the Supporting Shareholders, together with any other shareholder of YS Biopharma who currently is or subsequently becomes a party to YS Biopharma's shareholders agreement, are entitled to customary demand and piggyback registration rights. YS Biopharma also agrees to file a registration statement on Form F-1 within 20 days after the Closing (or 60 days if additional financial information is required) to register the registrable securities pursuant to YS Biopharma's shareholders agreement.

Rule 144

All of the Ordinary Shares held by the pre-Closing shareholders of YS Biopharma were acquired in transactions under an exemption or exclusion from the registration requirement under Section 5 of the Securities Act, and accordingly, are "restricted securities" as defined under Rule 144 under the Securities Act ("Rule 144"). Pursuant to Rule 144, a person who has beneficially owned Ordinary Shares or YS Biopharma Warrants that are "restricted securities" as defined under Rule 144 for at least six months would be entitled to sell their securities; provided that (1) such person is not deemed to have been one of YS Biopharma's affiliates at the time of, or at any time during the three months preceding, a sale and (2) YS Biopharma is subject to the Exchange Act periodic reporting requirements for at least three months before the sale and have filed all required reports under Section 13 or 15(d) of the Exchange Act during the 12 months (or such shorter period as it was required to file reports) preceding the sale.

[Table of Contents](#)

Persons who have beneficially owned Ordinary Shares or YS Biopharma Warrants that are “restricted securities” as defined under Rule 144 for at least six months but who are YS Biopharma’s affiliates at the time of, or at any time during the three months preceding, a sale, would be subject to additional restrictions, by which such person would be entitled to sell within any three-month period only a number of securities that does not exceed the greater of:

- one percent of the total number of Ordinary Shares then issued and outstanding; or
- the average weekly reported trading volume of the Ordinary Shares during the four calendar weeks preceding the filing of a notice on Form 144 with respect to the sale.

Sales by YS Biopharma’s affiliates under Rule 144 are also limited by manner of sale provisions and notice requirements and to the availability of current public information about YS Biopharma.

TAXATION

U.S. Federal Income Tax Considerations to U.S. Holders

General

The following is a general discussion of certain material U.S. federal income tax consequences to U.S. Holders (as defined below) of the ownership and disposition of the Ordinary Shares by a U.S. Holder (as defined below). This discussion is based on the federal income tax laws of the United States as of the date of this prospectus, including the United States Internal Revenue Code of 1986, as amended, (the “Code”), existing and proposed United States Treasury Regulations promulgated thereunder, judicial authority, published administrative positions of the United States Internal Revenue Service (the “IRS”), and other applicable authorities, all as of the date of this prospectus. All of the foregoing authorities are subject to change, which change could apply retroactively and could significantly affect the tax consequences described below. YS Group has not sought, nor does YS Group intend to seek, any ruling from the IRS with respect to the United States federal income tax consequences described below, and there can be no assurance that the IRS will not take, and a court would sustain, a contrary position. This discussion, moreover, does not address the United States federal estate, gift, Medicare, and alternative minimum tax or other non-income tax considerations, or any state, local or non-United States tax considerations, relating to an investment in YS Biopharma’s ordinary shares.

Except as specifically described below, this discussion does not address any tax consequences or reporting obligations that may be applicable to persons to the extent such tax consequences or reporting obligations arise from holding YS Group’s ordinary shares through a bank, financial institution or other entity, or a branch thereof, located, organized or resident outside the United States and does not describe any tax considerations arising in respect of the Foreign Account Tax Compliance Act (“FATCA”).

This discussion applies only to a U.S. Holders (as defined below) that hold YS Biopharma’s Ordinary Shares, as capital assets for United States federal income tax purposes (generally, property held for investment). This discussion does not address all aspects of U.S. federal income taxation that may be important to U.S. Holders in light of their individual circumstances, including U.S. Holders subject to special treatment under U.S. tax laws, such as, for example:

- banks and certain other financial institutions;
- insurance companies;
- regulated investment companies;
- real estate investment trusts;
- controlled foreign corporations;
- “qualified foreign pension funds” (within the meaning of Section 897(l)(2) of the Code) and entities whose interests are held by qualified foreign pension funds;
- dealers, brokers or traders in securities, commodities or foreign currencies;
- persons that use or are required to use a market-to-market method of accounting;
- accrual method taxpayers that file applicable financial statements as described in Section 451(b) of the Code; 191
- certain former citizens or residents of the United States subject to Section 877 of the Code;
- entities subject to the United States anti-inversion rules;
- tax-exempt organizations and entities;
- individual retirement accounts and Roth IRAs;
- S corporations;
- PFICs or their stockholders;

[Table of Contents](#)

- persons whose functional currency is other than the United States dollar;
- persons holding Ordinary Shares as part of a straddle, hedging, conversion or integrated transaction;
- persons that actually or constructively own Ordinary Shares representing 5% or more of YS Biopharma's total voting power or value;
- persons who acquired Ordinary Shares pursuant to the exercise of an employee stock option or otherwise as compensation;
- partnerships or other pass-through entities, or persons holding Ordinary Shares through such entities;
- persons required to accelerate the recognition of any item of gross income with respect to Ordinary Shares as a result of such income being recognized on an applicable financial statement; or
- non-U.S. Holders.

This discussion does not consider the U.S. federal income tax treatment of partnerships or other passthrough entities or persons that hold Ordinary Shares, through such entities. If a partnership (or other entity or arrangement classified as a partnership for U.S. federal income tax purposes) is the owner of YS Biopharma's shares, the U.S. federal income tax treatment of the partnership or a partner in the partnership generally will depend on the status of the partner and the activities of the partner and the partnership. A partnership or partner in a partnership holding Ordinary Shares should consult their tax advisors regarding the tax consequences of investing in and holding Ordinary Shares.

THE FOLLOWING DISCUSSION IS FOR INFORMATIONAL PURPOSES ONLY AND IS NOT A SUBSTITUTE FOR CAREFUL TAX PLANNING AND ADVICE. HOLDERS SHOULD CONSULT THEIR TAX ADVISORS WITH RESPECT TO THE APPLICATION OF THE UNITED STATES FEDERAL INCOME TAX LAWS TO THEIR PARTICULAR SITUATIONS, AS WELL AS ANY TAX CONSEQUENCES ARISING UNDER THE UNITED STATES FEDERAL ESTATE OR GIFT TAX LAWS OR THE LAWS OF ANY STATE, LOCAL OR NON-UNITED STATES TAXING JURISDICTION OR UNDER ANY APPLICABLE TAX TREATY.

For purposes of the discussion below, a "U.S. Holder" is a beneficial owner of Ordinary Shares that is, for United States federal income tax purposes:

- an individual who is a citizen or resident of the United States; transaction;
- a corporation (or other entity that is treated as a corporation for U.S. federal income tax purposes) that is created or organized (or treated as created or organized) in or under the laws of the U.S. or any state thereof or the District of Columbia;
- an estate, the income of which is subject to United States federal income taxation regardless of its source; or
- a trust if (i) a U.S. court can exercise primary supervision over the administration of such trust and one or more U.S. persons (within the meaning of the Code) have the authority to control all substantial decisions of the trust or (ii) it has a valid election in place to be treated as a U.S. person.

Ownership and Disposition of YS Biopharma's Ordinary Shares

Distributions on Ordinary Shares

Subject to the PFIC rules discussed below, the gross amount of any distributions YS Biopharma makes to you with respect to its Ordinary Shares (without reduction for any amounts withheld) generally will be includible in a U.S. Holder's gross income as foreign source dividend income on the date of receipt by such U.S. Holder, but only to the extent the distribution is paid out of YS Biopharma's current or accumulated earnings and profits (as determined under U.S. federal income tax principles). Such dividends paid by YS Biopharma will be taxable to a corporate U.S. Holder at regular rates and will not be eligible for the dividends-received deduction generally allowed to domestic corporations in respect of dividends received from other domestic corporations. Distributions in excess of such earnings and profits generally will be applied against and reduce (but not below zero) the U.S. Holder's adjusted tax basis in Ordinary Shares and, to the extent in excess of such basis, will be treated as gain from the sale

[Table of Contents](#)

or exchange of such shares (see “— Gain or Loss on Sale or Other Taxable Disposition of YS Biopharma Securities” below). YS Biopharma does not intend to provide calculations of its earnings and profits under U.S. federal income tax principles. A U.S. Holder should expect all distributions to be reported as dividends for U.S. federal income tax purposes.

With respect to certain non-corporate U.S. Holders, including individual U.S. Holders, dividends may be taxed at the lower capital gains rate applicable to “qualified dividend income,” provided that (1) Ordinary Shares are readily tradable on an established securities market in the United States or YS Biopharma is eligible for the benefits of a qualifying income tax treaty with the United States, (2) YS Biopharma is neither a PFIC nor treated as such with respect to you (as discussed below) for the taxable year in which the dividend is paid or the preceding taxable year, and (3) the Ordinary Shares are held for a holding period of more than 60 days during the 121-day period beginning 60 days before the ex-dividend date. Ordinary shares are generally considered for the purpose of clause (1) above to be readily tradable on an established securities market in the United States if they are listed on Nasdaq, as YS Biopharma’s ordinary shares currently are. If YS Biopharma is treated as a “resident enterprise” for PRC tax purposes, it may be eligible for the benefits of the income tax treaty between the United States and the PRC (the “Treaty”). U.S. Holders should consult their own tax advisors regarding the availability of the lower capital gains rate applicable to qualified dividend income for any dividends paid with respect to Ordinary Shares.

Any non-U.S. withholding tax (including any PRC withholding tax paid (or deemed paid) by a United States Holder at the rate applicable to such holder may be eligible for foreign tax credits (or deduction in lieu of such credits) for U.S. federal income tax purposes, subject to applicable limitations. Any dividends will constitute foreign source income for foreign tax credit limitation purposes. If the dividends are taxed as qualified dividend income (as discussed above), the amount of the dividend taken into account for purposes of calculating the foreign tax credit limitation will in general be limited to the gross amount of the dividend, multiplied by the reduced tax rate applicable to qualified dividend income and divided by the highest tax rate normally applicable to dividends. The limitation on foreign taxes eligible for credit is calculated separately with respect to specific classes of income. For this purpose, any dividends distributed by YS Biopharma with respect to ordinary shares will generally constitute “passive category income.”

The rules governing the foreign tax credit are complex and U.S. Holders should consult their tax advisors to determine whether and to what extent a credit would be available in their particular circumstances, including the effects of any applicable income tax treaties.

Sale, Exchange, Redemption or Other Taxable Disposition of YS Biopharma’s Ordinary Shares

Subject to the PFIC rules discussed below, upon a sale or other taxable disposition of YS Biopharma’s Ordinary Shares, a U.S. Holder will generally recognize capital gain or loss. The amount of gain or loss recognized will generally be equal to the difference between (i) the sum of the amount of cash and the fair market value of any property received in such disposition and (ii) the U.S. Holder’s adjusted tax basis in YS Biopharma’s Ordinary Shares.

Under tax law currently in effect long-term capital gains recognized by non-corporate U.S. Holders are generally subject to United States federal income tax at a reduced rate of tax. Capital gain or loss will constitute long-term capital gain or loss if the U.S. Holder’s holding period for the Ordinary Shares exceeds one year. The deductibility of capital losses is subject to various limitations.

Any gain or loss that a U.S. Holder recognizes on a disposition of YS Biopharma’s Ordinary Shares generally will be treated as United States-source income or loss for foreign tax credit limitation purposes. However, if YS Biopharma is treated as a PRC resident enterprise for PRC tax purposes and PRC tax is imposed on gain from the disposition of its Ordinary Shares, then a U.S. Holder that is eligible for the benefits of the Treaty may elect to treat the gain as PRC-source income for foreign tax credit purposes. If such an election is made, the gain so treated will be treated as a separate class or “basket” of income for foreign tax credit purposes. You should consult your tax advisors regarding the proper treatment of gain or loss, as well as the availability of a foreign tax credit, in your particular circumstances.

Passive Foreign Investment Company Rules

The U.S. federal income consequences could be materially different from those described above if Summit or YS Biopharma is or was treated as a PFIC for U.S. federal income tax purposes.

Definition of a PFIC

For any taxable year, a non-U.S. corporation generally will be classified as a PFIC for U.S. federal income tax purposes if either (i) at least 75% of its gross income for such taxable year is passive income or (ii) at least 50% of its assets (based on an average of the quarterly values of the assets) during such taxable year produce or are held for the production of passive income. Passive income generally includes dividends, interest, rents and royalties (other than rents or royalties derived from the active conduct of a trade or business) and gains from the disposition of passive assets. For purposes of the above calculations, a non-U.S. corporation that directly or indirectly owns at least 25% by value of the shares of another corporation is treated as holding and receiving directly its proportionate share of income and assets of such corporation.

PFIC Status of YS Biopharma

Based on the expected income, assets, and operations of YS Biopharma and its subsidiaries, YS Biopharma does not expect to be a PFIC in the taxable year that includes the Business Combination, although there can be no assurance in this regard. The determination of whether YS Biopharma is a PFIC is made on an annual basis and will depend on the composition of income and assets of YS Biopharma and its subsidiaries, and the value of the assets of YS Biopharma and its subsidiaries, from time to time. The calculation of the value of the assets of YS Biopharma and its subsidiaries will be based, in part, on the quarterly market value of Ordinary Shares, which is subject to change and may be volatile. The determination of whether YS Biopharma is a PFIC also will depend, in part, on how, and how quickly, it uses its liquid assets and cash, including the cash acquired from Summit in the Business Combination. If YS Biopharma were to retain significant amounts of liquid assets, including cash, the risk of YS Biopharma being classified as a PFIC may substantially increase. Because there are uncertainties in the application of the relevant rules and PFIC status is a factual determination made annually after the close of each taxable year, there can be no assurance that YS Biopharma will not be a PFIC for the taxable year that includes the Business Combination or any future taxable year, and no opinion of counsel has or will be provided regarding the classification of YS Biopharma as a PFIC.

Application of PFIC Rules to YS Biopharma Securities

If YS Biopharma is classified as a PFIC for any taxable year during which a U.S. Holder held Ordinary Shares, YS Biopharma would continue to be treated as a PFIC with respect to such investment unless (i) it ceased to be a PFIC and (ii) the U.S. Holder made a purging election with respect to its Ordinary Shares, as applicable. Under one type of purging election, the U.S. Holder will be deemed to have sold such shares at their fair market value and any gain recognized on such deemed sale will be treated as an excess distribution, as described below. As a result of such purging election, the U.S. Holder will have additional tax basis (to the extent of any gain recognized on such deemed sale) and, solely for purposes of the PFIC rules, a new holding period in such shares. U.S. Holders should consult their advisors regarding the application of the purging election rules in their particular circumstances.

If YS Biopharma is determined to be a PFIC for any taxable year during which a U.S. Holder held Ordinary Shares, as applicable, such U.S. Holder generally would be subject to special and adverse rules with respect to (i) any gain recognized by such U.S. Holder on the sale or other taxable disposition of its Ordinary Shares, as applicable, and (ii) any "excess distribution" made to such U.S. Holder (generally, any distributions to such U.S. Holder during a taxable year of the U.S. Holder that are greater than 125% of the average annual distributions received by such U.S. Holder in respect of Summit Public Shares or Ordinary Shares, as applicable, during the three preceding taxable years or, if shorter, such U.S. Holder's holding period in the Summit Public Shares or for the Ordinary Shares, as applicable).

Under these rules:

- the U.S. Holder's gain or excess distribution will be allocated ratably over the U.S. Holder's holding period in the Summit Public Shares or Ordinary Shares, as applicable;
- the amount allocated to the U.S. Holder's taxable year in which the U.S. Holder recognized the gain or received the excess distribution, or to the period in the U.S. Holder's holding period before the first day of the first taxable year of Summit or YS Biopharma, as applicable, in which Summit or YS Biopharma, as applicable, was a PFIC, will be taxed as ordinary income;

Table of Contents

- the amount allocated to each other taxable year of the U.S. Holder and included in its holding period will be taxed at the highest tax rate in effect for such taxable year and applicable to the U.S. Holder; and
- an additional tax equal to the interest charge generally applicable to underpayments of tax will be imposed on the U.S. Holder with respect to the tax attributable to each such other taxable year of the U.S. Holder.

If YS Biopharma is a PFIC and, at any time, has a non-U.S. subsidiary that is classified as a PFIC, a U.S. Holder generally would be deemed to own a portion of the shares of such lower-tier PFIC, and generally could incur liability for the deferred tax and interest charge described above if YS Biopharma (or a subsidiary of YS Biopharma) receives a distribution from, or disposes of all or part of its interest in, the lower-tier PFIC or the U.S. Holders otherwise were deemed to have disposed of an interest in the lower-tier PFIC. U.S. Holders should consult their tax advisors regarding the tax issues raised by lower-tier PFICs.

QEF and Mark-to-Market Elections Available to U.S. Holders of YS Biopharma Securities

In general, a U.S. Holder may avoid the adverse PFIC tax consequences described above in respect of the Ordinary Shares by making and maintaining a timely and valid QEF election (if eligible to do so) to include in income its pro rata share of the net capital gains (as long-term capital gain) and other earnings and profits (as ordinary income) of YS Biopharma on a current basis, whether or not distributed, in the taxable year of the U.S. Holder in which the taxable year of YS Biopharma ends. To comply with the requirements of a QEF election, a U.S. Holder must receive a PFIC Annual Information Statement from YS Biopharma. YS Biopharma intends to provide the information necessary for a U.S. Holder to make and maintain a QEF election with respect to Ordinary Shares for the taxable year that includes the Business Combination and the following taxable year if YS Biopharma determines that it is a PFIC for such taxable year, but may not make such information available in subsequent taxable years even if it determines that it is a PFIC for such subsequent taxable year.

The QEF election is made on a shareholder-by-shareholder basis and, once made, can be revoked only with the consent of the IRS. A U.S. Holder generally makes a QEF election by attaching a completed IRS Form 8621 (Information Return by a Shareholder of a Passive Foreign Investment Company or Qualified Electing Fund), including the information provided in a PFIC Annual Information Statement, to a timely filed U.S. federal income tax return for the taxable year to which the election relates. Retroactive QEF elections generally may be made only by filing a protective statement with such return and if certain other conditions are met or with the consent of the IRS. U.S. Holders should consult their tax advisors regarding the availability and tax consequences of a retroactive QEF election in their particular circumstances.

Alternatively, if YS Biopharma is classified as a PFIC and Ordinary Shares constitute “marketable stock,” a U.S. Holder may avoid the adverse PFIC tax consequences discussed above if such U.S. Holder, at the close of the first taxable year in which it holds (or is deemed to hold) Ordinary Shares, makes a mark-to-market election with respect to such shares for such taxable year. Such U.S. Holder generally will include for each of its taxable years as ordinary income the excess, if any, of the fair market value of its Ordinary Shares at the end of such taxable year, over its adjusted tax basis in its Ordinary Shares. The U.S. Holder also will recognize an ordinary loss in respect of the excess, if any, of its adjusted tax basis of its Ordinary Shares, over the fair market value of its Ordinary Shares at the end of its taxable year (but only to the extent of the net amount of previously included income as a result of the mark-to-market election). The U.S. Holder’s adjusted tax basis in its Ordinary Shares will be adjusted to reflect any such income or loss amounts, and any further gain recognized on a sale or other taxable disposition of its Ordinary Shares will be treated as ordinary income. Moreover, a mark-to-market election made with respect to Ordinary Shares would not apply to a U.S. Holder’s indirect interest in any lower-tier PFICs in which YS Biopharma owns shares.

The mark-to-market election is available only for “marketable stock,” generally, stock that is regularly traded on a national securities exchange that is registered with the SEC, including Nasdaq (on which Ordinary Shares will be listed), or on a foreign exchange or market that the IRS determines has rules sufficient to ensure that the market price represents a legitimate and sound fair market value.

U.S. Holders should consult their tax advisors regarding the availability and tax consequences of a QEF election or a mark-to-market election in their particular circumstances.

[Table of Contents](#)

A U.S. Holder that owns (or is deemed to own) shares in a PFIC during any taxable year of the U.S. Holder may have to file an IRS Form 8621 and such other information as may be required by the U.S. Treasury Department. Failure to do so, if required, will extend the statute of limitations until such required information is furnished to the IRS.

The PFIC rules are very complex and are affected by various factors in addition to those described above. Accordingly, U.S. Holders should consult their tax advisors regarding the application of the PFIC rules in their particular circumstances.

Information Reporting and Backup Withholding Applicable to U.S. Holders of YS Biopharma Securities

Dividend payments (including constructive dividends) with respect to Ordinary Shares and proceeds from the sale, exchange, or redemption of YS Biopharma Securities may be subject to information reporting to the IRS and possible United States backup withholding. Backup withholding will not apply, however, to a U.S. Holder that furnishes a correct taxpayer identification number (generally on an IRS Form W-9) and makes other required certifications, or that is otherwise exempt from backup withholding and establishes such exempt status. Backup withholding is not an additional tax. Any amounts withheld under the backup withholding rules may be allowed as a refund or credit against a U.S. Holder's U.S. federal income tax liability, provided that the required information is timely furnished to the IRS. U.S. Holders should consult their tax advisors regarding any required information reporting and the application of the backup withholding rules in their particular circumstances.

Certain U.S. Holders are required to report information to the IRS relating to an interest in "specified foreign financial assets," including shares issued by a non-United States corporation, for any year in which the aggregate value of all specified foreign financial assets exceeds \$50,000 (or a higher dollar amount prescribed by the IRS), subject to certain exceptions (including an exception for shares held in custodial accounts maintained with a United States financial institution). These rules also impose penalties if a U.S. Holder is required to submit such information to the IRS and fails to do so. U.S. Holders should consult their own tax advisers regarding the application of these reporting requirements.

THE U.S. FEDERAL INCOME TAX DISCUSSION SET FORTH ABOVE IS INCLUDED FOR GENERAL INFORMATION ONLY AND IS NOT TAX ADVICE. U.S. HOLDERS SHOULD CONSULT THEIR TAX ADVISORS REGARDING THE U.S. FEDERAL, STATE, AND LOCAL AND NON-U.S. INCOME AND NON-INCOME TAX CONSEQUENCES OF THE BUSINESS COMBINATION, OF THE EXERCISE OF REDEMPTION RIGHTS WITH RESPECT TO SUMMIT PUBLIC SHARES, AND OF THE OWNERSHIP AND DISPOSITION OF YS BIOPHARMA SECURITIES AFTER THE BUSINESS COMBINATION, INCLUDING THE IMPACT OF ANY ACTUAL OR POTENTIAL CHANGE IN TAX LAW.

Cayman Islands Tax Considerations

Prospective investors should consult their professional advisers on the possible tax consequences of buying, holding or selling shares under the laws of their country of citizenship, residence or domicile.

The following is a discussion on certain Cayman Islands income tax consequences of an investment in the Ordinary Shares. The discussion is a general summary of present law, which is subject to prospective and retroactive change. It is not intended as tax advice, does not consider any investor's particular circumstances, and does not consider tax consequences other than those arising under Cayman Islands law.

Payments of dividends and capital in respect of YS Biopharma's ordinary shares will not be subject to taxation in the Cayman Islands and no withholding will be required on the payment of interest and principal or a dividend or capital to any holder of YS Biopharma's ordinary shares, as the case may be, nor will gains derived from the disposal of YS Biopharma's ordinary shares be subject to Cayman Islands income or corporation tax.

The Cayman Islands currently levies no taxes on individuals or corporations based upon profits, income, gains or appreciation and there is no taxation in the nature of inheritance tax or estate duty. There are no other taxes likely to be material to YS Biopharma levied by the government of the Cayman Islands except for stamp duties which may be applicable on instruments executed in, or after execution brought within the jurisdiction of the Cayman Islands. The Cayman Islands is not party to any double tax treaties applicable to payments to or by YS Biopharma. There are no exchange control regulations or currency restrictions in the Cayman Islands.

[Table of Contents](#)

YS Biopharma is incorporated under the laws of the Cayman Islands as an exempted company with limited liability and, as such, has received an undertaking from the Governor in Cabinet of the Cayman Islands in the following form:

The Tax Concessions Act
Undertaking as to Tax Concessions

In accordance with the Tax Concessions Act (As Revised) of the Cayman Islands, the Governor in Cabinet undertakes with YS Biopharma:

- (a) That no law which is hereafter enacted in the Cayman Islands imposing any tax to be levied on profits, income, gains or appreciations shall apply to YS Biopharma or its operations; and
- (b) In addition, that no tax to be levied on profits, income, gains or appreciations or which is in the nature of estate duty or inheritance tax shall be payable:
 - (i) on or in respect of the shares, debentures or other obligations of YS Biopharma; or
 - (ii) by way of the withholding in whole or part, of any relevant payment as defined in the Tax Concessions Act (As Revised).

These concessions shall be for a period of TWENTY years from October 4, 2022.

Material PRC Tax Considerations

Under the EIT Law and its implementation rules, an enterprise established outside of China with a “de facto management body” within China is considered a resident enterprise and will be subject to the enterprise income tax at the rate of 25% on its global income. The implementation rules define the term “de facto management body” as the body that exercises full and substantial control over and overall management of the business, productions, personnel, accounts and properties of an enterprise. In April 2009, SAT issued the Circular 82, which provides certain specific criteria for determining whether the “de facto management body” of a PRC-controlled enterprise that is incorporated offshore is located in China. Although the Circular 82 only applies to offshore enterprises controlled by PRC enterprises or PRC enterprise groups, not those controlled by PRC individuals or foreigners, the criteria set forth in the Circular 82 may reflect the general position of SAT on how the “de facto management body” test should be applied in determining the tax resident status of all offshore enterprises. According to the Circular 82, an offshore incorporated enterprise controlled by a PRC enterprise or a PRC enterprise group will be regarded as a PRC tax resident by virtue of having its “de facto management body” in China only if all of the following conditions are met: (1) the primary location of the day-to-day operational management to perform their duties is in China; (2) decisions relating to the enterprise’s financial and human resource matters are made or are subject to approval by organizations or personnel in China; (3) the enterprise’s primary assets, accounting books and records, company seals, and board and shareholder resolutions, are located or maintained in China; and (4) at least 50% of voting board members or senior executives habitually reside in China.

YS Biopharma does not believe that YS Biopharma, a Cayman Islands holding company meets all of the conditions above. It is not a PRC resident enterprise for PRC tax purposes. As a holding company, its key assets are its ownership interests in its subsidiaries, and its key assets are located, and its records (including the resolutions of its board of directors and the resolutions of its shareholders) are maintained, outside China. For the same reasons, YS Biopharma believes other YS Biopharma’s subsidiaries outside of China are not PRC resident enterprises either. However, the tax resident status of an enterprise is subject to determination by the PRC tax authorities and uncertainties remain with respect to the interpretation of the term “de facto management body.” There can be no assurance that the PRC government will ultimately take a view that is consistent with ours.

Jingtian & Gongcheng, YS Biopharma’s legal counsel as to the PRC law, advised YS Biopharma that if the PRC tax authorities determine that YS Biopharma, a Cayman Islands holding company, is a PRC resident enterprise for enterprise income tax purposes, YS Biopharma may be required to withhold a 10% withholding tax from dividends it pays to its security holders that are non-resident enterprises, including the holders of the ordinary shares and warrants. In addition, non-resident enterprise shareholders (including the holders of ordinary shares and warrants) may be subject to a 10% PRC tax on gains realized on the sale or other disposition of such securities, if such income is treated

[Table of Contents](#)

as sourced from within China. It is unclear whether YS Biopharma's non-PRC individual shareholders (including the holders of ordinary shares and warrants) would be subject to any PRC tax on dividends or gains obtained by such non-PRC individual shareholders in the event it is determined to be a PRC resident enterprise. If any PRC tax were to apply to such dividends or gains, it would generally apply at a rate of 20% unless a reduced rate is available under an applicable tax treaty. However, it is also unclear whether non-PRC shareholders of YS Biopharma would be able to claim the benefits of any tax treaties between their country of tax residence and China in the event that YS Biopharma is treated as a PRC resident enterprise.

If YS Biopharma is not deemed to be a PRC resident enterprise, holders of its securities (including ordinary shares and warrants) who are not PRC residents will not be subject to PRC income tax on dividends distributed by it or gains realized from the sale or other disposition of its securities. However, under SAT Bulletin 7, where a non-resident enterprise conducts an "indirect transfer" by transferring taxable assets, including, in particular, equity interests in a PRC resident enterprise, indirectly by disposing of the equity interests of an overseas holding company, the non-resident enterprise, being the transferor, or the transferee or the PRC entity which directly owned such taxable assets may report to the relevant tax authority such indirect transfer. Using a "substance over form" principle, the PRC tax authority may disregard the existence of the overseas holding company if it lacks a reasonable commercial purpose and was established for the purpose of reducing, avoiding or deferring PRC tax. As a result, gains derived from such indirect transfer may be subject to PRC enterprise income tax, and the transferee obligated to withhold the applicable taxes, currently at 10% for the transfer of equity interests in a PRC resident enterprise. YS Biopharma and its non-PRC resident investors may be at risk of being required to file a return and being taxed under SAT Bulletin 7, and YS Biopharma may be required to expend valuable resources to comply with SAT Bulletin 7, or to establish that it should not be taxed thereunder. See "Risk Factors — Risks Related to Doing Business in China."

PLAN OF DISTRIBUTION

We are registering the resale by the Selling Securityholders named in this prospectus of up to 24,130,762 Ordinary Shares. As used herein, "Selling Securityholders" includes donees, pledgees, transferees or other successors-in-interest (as a gift, pledge, partnership distribution or other non-sale related transfer) selling securities received after the date of this prospectus from the Selling Securityholders.

We are registering the foregoing securities so that those securities may be freely sold to the public by the Selling Securityholders. We have agreed with certain Selling Securityholders pursuant to the Registration Rights Agreement to use commercially reasonable efforts to keep the registration statement of which this prospectus constitutes a part effective until such time as such Selling Securityholders cease to hold any securities eligible for registration under the Registration Rights Agreement. The Selling Securityholders may offer and sell, from time to time, some or all of the securities covered by this prospectus, and each Selling Securityholder will act independently of us in making decisions with respect to the timing, manner and size of any sale. However, there can be no assurance that the Selling Securityholders will sell all or any of the securities offered by this prospectus.

The securities registered for resale by the Selling Securityholders named in the prospectus are subject to 180 days lock-up period from March 16, 2023. The lockup requirements will cease to apply after the date on which the closing price of the Ordinary Shares equals or exceeds \$12.00 per share for any 20 trading days within any 30 trading day period commencing at least 150 days after March 16, 2023.

We will not receive any proceeds from any sale by the Selling Securityholders of the securities being registered hereunder. The aggregate proceeds to the Selling Securityholders will be the aggregate purchase price of the securities sold less any discounts and commissions borne by the Selling Securityholders. We will bear all costs, expenses and fees in connection with the registration of the securities offered by this prospectus, whereas the Selling Securityholders will bear all commissions and discounts, if any, attributable to their sale of our Ordinary Shares. Our Ordinary Shares and Warrants are currently listed on Nasdaq under the symbols "YS" and "YSBPW," respectively.

Subject to the terms of the agreements governing the registration rights applicable to a Selling Securityholder's shares of our Ordinary Shares, the Selling Securityholders may use any one or more of the following methods when selling the securities offered by this prospectus:

- purchases by a broker-dealer as principal and resale by such broker-dealer for its own account pursuant to this prospectus;
- ordinary brokerage transactions and transactions in which the broker solicits purchasers;
- block trades in which the broker-dealer so engaged will attempt to sell the securities as agent but may position and resell a portion of the block as principal to facilitate the transaction;
- an over-the-counter distribution in accordance with the rules of Nasdaq;
- through trading plans entered into by a Selling Securityholder pursuant to Rule 10b5-1 under the Exchange Act that are in place at the time of an offering pursuant to this prospectus and any applicable prospectus supplement hereto that provide for periodic sales of their securities on the basis of parameters described in such trading plans;
- through one or more underwritten offerings on a firm commitment or best-efforts basis;
- settlement of short sales entered into after the date of this prospectus;
- agreements with broker-dealers to sell a specified number of the securities at a stipulated price per share;
- distribution to employees, members, limited partners or stockholders of the Selling Securityholder or its affiliates by pledge to secure debts and other obligations;
- delayed delivery arrangements;

Table of Contents

- in “at the market” offerings, as defined in Rule 415 under the Securities Act, at negotiated prices, at prices prevailing at the time of sale or at prices related to such prevailing market prices, including sales made directly on a national securities exchange or sales made through a market maker other than on an exchange or other similar offerings through sales agents;
- directly to purchasers, including through a specific bidding, auction or other process or in privately negotiated transactions;
- through the writing or settlement of options or other hedging transactions, whether through an options exchange or otherwise;
- through a combination of any of the above methods of sale; or
- any other method permitted pursuant to applicable law.

The Selling Securityholders may sell the securities at prices then prevailing, related to the then prevailing market price or at negotiated prices. The offering price of the securities from time to time will be determined by the Selling Securityholders and, at the time of the determination, may be higher or lower than the market price of our securities on Nasdaq or any other exchange or market. The Selling Securityholders have the sole and absolute discretion not to accept any purchase offer or make any sale of securities if they deem the purchase price to be unsatisfactory at any particular time or for any other reason.

With respect to a particular offering of the securities held by the Selling Securityholders, to the extent required, an accompanying prospectus supplement will be or, if appropriate, a post-effective amendment to the registration statement of which this prospectus is part may be, prepared and will set forth the following information:

- the specific securities to be offered and sold;
- the names of the Selling Securityholders;
- the respective purchase prices and public offering prices, the proceeds to be received from the sale, if any, and other material terms of the offering;
- settlement of short sales entered into after the date of this prospectus;
- the names of any participating agents, broker-dealers or underwriters; and
- any applicable commissions, discounts, concessions and other items constituting compensation from the Selling Securityholders.

To the extent required, we will use our best efforts to file a post-effective amendment to the registration statement of which this prospectus is part to describe any material information with respect to the plan of distribution not previously disclosed in this prospectus or any material change to such information, and this prospectus may be amended or supplemented from time to time to describe a specific plan of distribution.

Subject to the terms of the agreements governing the registration rights applicable to a Selling Securityholder’s Ordinary Shares, the Selling Securityholders also may transfer the securities in other circumstances, in which case the transferees, pledgees or other successors-in-interest will be the Selling Securityholders for purposes of this prospectus. Upon being notified by a Selling Securityholder that a donee, pledgee, transferee, other successor-in-interest intends to sell our securities, we will, to the extent required, promptly file a supplement to this prospectus or post-effective amendment to name specifically such person as a Selling Securityholder.

In addition, a Selling Securityholder that is an entity may elect to make a pro rata in-kind distribution of securities to its members, partners or shareholders pursuant to the registration statement of which this prospectus is a part by delivering a prospectus with a plan of distribution. Such members, partners or shareholders would thereby receive freely tradeable securities pursuant to the distribution through a registration statement. To the extent a distributee is an affiliate of ours (or to the extent otherwise required by law), we may file a prospectus supplement or post-effective amendment in order to permit the distributees to use the prospectus to resell the securities acquired in the distribution.

The Selling Securityholders may also sell securities under Rule 144 under the Securities Act, if available, or in other transactions exempt from registration, rather than under this prospectus.

[Table of Contents](#)

If any of the Selling Securityholders uses an underwriter or underwriters for any offering, we will name such underwriter or underwriters, and set forth the terms of the offering, in a prospectus supplement pertaining to such offering and, except to the extent otherwise set forth in such prospectus, the applicable Selling Securityholders will agree in an underwriting agreement to sell to the underwriter(s), and the underwriter(s) will agree to purchase from the Selling Securityholders, the number of shares set forth in such prospectus supplement. These sales may be at a fixed price or varying prices, which may be changed, or at market prices prevailing at the time of sale, at prices relating to prevailing market prices or at negotiated prices. The securities may be offered to the public through underwriting syndicates represented by managing underwriters or by one or more underwriters without a syndicate. The obligations of the underwriters to purchase the securities will be subject to certain conditions. Unless otherwise set forth in such prospectus supplement, the underwriters will be obligated to purchase all the securities offered if any of the securities are purchased.

Underwriters, broker-dealers or agents may facilitate the marketing of an offering online directly or through one of their affiliates. In those cases, prospective investors may view offering terms and a prospectus online and, depending upon the particular underwriter, broker-dealer or agent, place orders online or through their financial advisors.

In offering the securities covered by this prospectus, the Selling Securityholders and any underwriters, broker-dealers or agents who execute sales for the Selling Securityholders may be deemed to be “underwriters” within the meaning of the Securities Act in connection with such sales. Any discounts, commissions, concessions or profit they earn on any resale of those securities may be underwriting discounts and commissions under the Securities Act.

The underwriters, broker-dealers and agents may engage in transactions with us or the Selling Securityholders, may have banking, lending or other relationships with us or the Selling Securityholders or perform services for us or the Selling Securityholders, in the ordinary course of business.

Upon our notification by a Selling Securityholder that any material arrangement has been entered into with an underwriter or broker-dealer for the sale of securities through a block trade, special offering, exchange distribution, secondary distribution or a purchase by an underwriter or broker-dealer, we will file, if required by applicable law or regulation, a supplement to this prospectus pursuant to Rule 424(b) under the Securities Act disclosing certain material information relating to such underwriter or broker-dealer and such offering.

In order to facilitate the offering of the securities, any underwriters, broker-dealers or agents, as the case may be, involved in the offering of such securities may engage in transactions that stabilize, maintain or otherwise affect the price of our securities. Specifically, the underwriters, broker-dealers or agents, as the case may be, may over allot in connection with the offering, creating a short position in our securities for their own account. In addition, to cover over allotments or to stabilize the price of our securities, the underwriters, broker-dealers or agents, as the case may be, may bid for, and purchase, such securities in the open market. Finally, in any offering of securities through a syndicate of underwriters, the underwriting syndicate may reclaim selling concessions allotted to an underwriter or a broker-dealer for distributing such securities in the offering if the syndicate repurchases previously distributed securities in transactions to cover syndicate short positions, in stabilization transactions or otherwise. Any of these activities may stabilize or maintain the market price of the securities above independent market levels. The underwriters, broker-dealers or agents, as the case may be, are not required to engage in these activities, and may end any of these activities at any time.

The Selling Securityholders may also authorize underwriters, broker-dealers or agents to solicit offers by certain purchasers to purchase the securities at the public offering price set forth in the prospectus supplement pursuant to delayed delivery contracts providing for payment and delivery on a specified date in the future. The contracts will be subject only to those conditions set forth in the prospectus supplement, and the prospectus supplement will set forth any commissions we or the Selling Securityholders pay for solicitation of these contracts.

In effecting sales, underwriters, broker-dealers or agents engaged by the Selling Securityholders may arrange for other broker-dealers to participate. Underwriters, broker-dealers or agents may receive commissions, discounts or concessions from the Selling Securityholders in amounts to be negotiated immediately prior to the sale.

It is possible that one or more underwriters may make a market in our securities, but such underwriters will not be obligated to do so and may discontinue any market making at any time without notice. We cannot give any assurance as to the liquidity of the trading market for our securities.

[Table of Contents](#)

A Selling Securityholder may enter into derivative transactions with third parties, including hedging transactions with broker-dealers or other financial institutions, or sell securities not covered by this prospectus to third parties in privately negotiated transactions. If the applicable prospectus supplement indicates, in connection with those derivatives, the third parties may sell securities covered by this prospectus and the applicable prospectus supplement, including in short sales of the securities offered hereby or of securities convertible into or exchangeable for such securities. If so, the third party may use securities pledged by any Selling Securityholder or borrowed from any Selling Securityholder or others to settle those sales or to close out any related open borrowings of stock, and may use securities received from any Selling Securityholder in settlement of those derivatives to close out any related open borrowings of shares. The third party in such sale transactions will be an underwriter and will be identified in the applicable prospectus supplement (or a post-effective amendment). In addition, any Selling Securityholder may otherwise loan or pledge securities to a financial institution or other third party that in turn may sell the securities short using this prospectus. Such financial institution or other third party may transfer its economic short position to investors in our securities or in connection with a concurrent offering of other securities.

In compliance with the guidelines of the Financial Industry Regulatory Authority (“FINRA”), the aggregate maximum discount, commission, fees or other items constituting underwriting compensation to be received by any FINRA member or independent broker-dealer will not exceed 8% of the gross proceeds of any offering pursuant to this prospectus and any applicable prospectus supplement.

If at the time of any offering made under this prospectus a member of FINRA participating in the offering has a “conflict of interest” as defined in FINRA Rule 5121 (“Rule 5121”), that offering will be conducted in accordance with the relevant provisions of Rule 5121.

In order to comply with the securities laws of certain states, if applicable, the securities must be sold in such jurisdictions only through registered or licensed brokers or dealers. In addition, in certain states the securities may not be sold unless they have been registered or qualified for sale in the applicable state or an exemption from the registration or qualification requirement is available and is complied with.

The Selling Securityholders and any other persons participating in the sale or distribution of the securities will be subject to applicable provisions of the Securities Act and the Exchange Act, and the rules and regulations thereunder, including, without limitation, Regulation M. These provisions may restrict certain activities of, and limit the timing of purchases and sales of any of the securities by, the Selling Securityholders or any other person, which limitations may affect the marketability of the shares of the securities.

We will make copies of this prospectus available to the Selling Securityholders for the purpose of satisfying the prospectus delivery requirements of the Securities Act.

We have agreed to indemnify the Selling Securityholders against certain liabilities, including liabilities under the Securities Act. The Selling Securityholders have agreed to indemnify us in certain circumstances against certain liabilities, including certain liabilities under the Securities Act. We and/or the Selling Securityholders may indemnify any broker or underwriter that participates in transactions involving the sale of the securities against certain liabilities, including liabilities arising under the Securities Act.

EXPENSES RELATED TO THE OFFERING

We estimate the following expenses in connection with the offer and sale of our Ordinary Shares by the Selling Securityholders. With the exception of the SEC Registration Fee, all amounts are estimates.

SEC registration fee	\$	4,108.48
FINRA filing fee		*
Legal fees and expenses		*
Accountants' fees and expenses	\$	15,000
Printing expenses	\$	58,000
Transfer agent fees and expenses		*
Miscellaneous costs	\$	600
Total	\$	77,708.48

* These fees are calculated based on the securities offered and the number of issuances and accordingly cannot be defined at this time.

Under agreements to which we are party with the Selling Securityholders, we have agreed to bear all expenses relating to the registration of the resale of the securities pursuant to this prospectus.

LEGAL MATTERS

YS Biopharma is being represented by Cooley LLP with respect to certain legal matters as to United States federal securities and New York State law, by Jingtian & Gongcheng with respect to certain legal matters as to PRC law, and by Maples and Calder (Hong Kong) LLP with respect to certain legal matters as to Cayman Islands law. Cooley LLP may rely upon Maples and Calder (Hong Kong) LLP with respect to matters governed by Cayman Islands law and Jingtian & Gongcheng with respect to matters governed by PRC law.

The validity of Ordinary Shares has been passed on by Maples and Calder (Hong Kong) LLP.

EXPERTS

The consolidated balance sheets of YS Biopharma Co., Ltd. as of March 31, 2022 and 2023, the related consolidated statements of operations and other comprehensive loss, changes in shareholder's equity and cash flows for each of the years in the three-year period ended March 31, 2023, and the related notes have been included herein in reliance upon the report of Wei, Wei & Co., LLP, an independent registered public accounting firm, appearing elsewhere herein, and upon the authority of said firm as experts in accounting and auditing.

ENFORCEABILITY OF CIVIL LIABILITIES AND AGENT FOR SERVICE OF PROCESS IN THE UNITED STATES

We are incorporated under the laws of the Cayman Islands to take advantage of certain benefits associated with being a Cayman Islands exempted company:

- political and economic stability;
- an effective judicial system;
- a favorable tax system;
- the absence of exchange control or currency restrictions; and
- the availability of professional and support services.

However, certain disadvantages accompany incorporation in the Cayman Islands. These disadvantages include, but are not limited to, the following:

- the Cayman Islands has a less exhaustive body of securities laws than the United States and these securities laws provide significantly less protection to investors; and
- Cayman Islands companies may not have standing to sue before the federal courts of the United States.

Our constitutional documents do not contain provisions requiring that disputes, including those arising under the securities laws of the United States, between us, our officers, directors and shareholders, be arbitrated.

We conduct substantially all of our operations outside the United States, and substantially all of our assets are located outside the United States. Substantially all of our officers are nationals or residents of jurisdictions other than the United States and a substantial portion of their assets are located outside the United States. As a result, it may be difficult or impossible for a shareholder to effect service of process within the United States upon us or these persons, or to enforce against us or them judgments obtained in United States courts, including judgments predicated upon the civil liability provisions of the securities laws of the United States or any state in the United States.

We have appointed Cogency Global Inc., located at 122 East, 42th Street, 18th Floor, New York, NY 10168, as our agent upon whom process may be served in any action brought against us under the securities laws of the United States.

Cayman Islands

Maples and Calder (Hong Kong) LLP, our counsel as to Cayman Islands law, has advised us that there is uncertainty as to whether the courts in the Cayman Islands would (1) recognize or enforce judgments of United States courts obtained against us or our directors or officers to impose liabilities against us predicated upon the civil liability provisions of the securities laws of the United States or any state in the United States; or (2) entertain original actions brought in each respective jurisdiction against us or our directors or officers predicated upon the federal securities laws of the United States or the securities laws of any state in the United States.

Maples and Calder (Hong Kong) LLP has further advised us that although there is no statutory enforcement in the Cayman Islands of judgments obtained in the federal or state courts of the United States (and the Cayman Islands are not a party to any treaties for the reciprocal enforcement or recognition of such judgments), the courts of the Cayman Islands would recognize as a valid judgment, a final and conclusive judgment *in personam* obtained in the federal or state courts in the United States under which a sum of money is payable (other than a sum of money payable in respect of multiple damages, taxes or other charges of a like nature or in respect of a fine or other penalty) or, in certain circumstances, an *in personam* judgment for non-monetary relief, and would give a judgment based thereon provided that (a) such courts had proper jurisdiction over the parties subject to such judgment, (b) such courts did not contravene the rules of natural justice of the Cayman Islands, (c) such judgment was not obtained by fraud, (d) the enforcement of the judgment would not be contrary to the public policy of the Cayman Islands, (e) no new admissible evidence relevant to the action is submitted prior to the rendering of the judgment by the courts of the Cayman Islands, and (f) there is due compliance with the correct procedures under the laws of the Cayman Islands. However, the Cayman Islands courts are unlikely to enforce a punitive judgment of a United States court predicated upon the civil

[Table of Contents](#)

liability provisions of the federal securities laws in the United States without retrial on the merits if such judgment is determined by the courts of the Cayman Islands to give rise to obligations to make payments that may be regarded as fines, penalties or punitive in nature.

The PRC

Jingtian & Gongcheng has advised us that the PRC Civil Procedures Law governs the recognition and enforcement of foreign judgments. PRC courts may recognize and enforce foreign judgments in accordance with the PRC Civil Procedures Law based either on treaties between China and the country where the judgment is made or on principles of reciprocity between jurisdictions.

The PRC does not have any treaties or other agreements with the United States or the Cayman Islands that provide for the reciprocal recognition and enforcement of foreign judgments. In addition, according to the PRC Civil Procedures Law, courts in the PRC will not enforce a foreign judgment against us or our directors and officers if they determine that the judgment violates the basic principles of PRC law or national sovereignty, security or public interest. As a result, it is uncertain whether a PRC court would enforce a judgment rendered by a court in the United States or the Cayman Islands. Under the PRC Civil Procedures Law, foreign shareholders may originate actions based on PRC law against us in the PRC, if they can establish sufficient nexus to the PRC for a PRC court to have jurisdiction, and meet other procedural requirements, including, among others, the plaintiff must have a direct interest in the case, and there must be a concrete claim, a factual basis and a cause for the suit.

In addition, it will be difficult for U.S. shareholders to originate actions against us in China in accordance with PRC laws because we are incorporated under the laws of the Cayman Islands and it will be difficult for U.S. shareholders, by virtue only of holding our ordinary shares, to establish a connection to China for a PRC court to have jurisdiction as required under the PRC Civil Procedures Law.

WHERE YOU CAN FIND MORE INFORMATION

We are subject to the periodic reporting and other information requirements of the Exchange Act as applicable to a “Foreign Private Issuer,” and we will file annual reports and other information from time to time with the SEC in accordance with such requirements. Our SEC filings will be available to the public on the internet at a website maintained by the SEC located at www.sec.gov.

We also maintain an Internet website at <https://www.ytbiopharm.com>. Through the “Investor Relations” portal available through our website, we will make available, free of charge, the following documents as soon as reasonably practicable after they are electronically filed with, or furnished to, the SEC: our Annual Reports on Form 20-F; our reports on Form 6-K; amendments to these documents; and other information as may be required by the SEC. The information contained on, or that may be accessed through, our website is not part of, and is not incorporated into, this prospectus.

As a foreign private issuer, we are exempt under the Exchange Act from, among other things, the rules prescribing the furnishing and content of proxy statements, and our officers, directors and principal shareholders are exempt from the reporting and short-swing profit recovery provisions contained in Section 16 of the Exchange Act. In addition, we will not be required under the Exchange Act to file periodic reports and financial statements with the SEC as frequently or as promptly as U.S. companies whose securities are registered under the Exchange Act.

**YS BIOPHARMA CO., LTD AND SUBSIDIARIES
INDEX TO CONSOLIDATED FINANCIAL STATEMENTS**

CONTENTS	Page(s)
Condensed Consolidated Balance Sheets as of September 30, 2023 (Unaudited) and March 31, 2023	F-2
Unaudited Condensed Consolidated Statements of Operations and Comprehensive Loss for the Six Months Ended September 30, 2023 and 2022	F-3
Unaudited Condensed Consolidated Statements of Changes in Shareholders' (Deficit)/Equity for the Six Months Ended September 30, 2023 and 2022	F-4
Unaudited Condensed Consolidated Statements of Cash Flows for the Six Months Ended September 30, 2023 and 2022	F-5
Notes to the Condensed Consolidated Financial Statements	F-6
Report of Independent Registered Public Accounting Firm (PCAOB ID:2388)	F-41
Consolidated Balance Sheets as of March 31, 2022 and 2023	F-42
Consolidated Statements of Operations and Comprehensive Loss for the Years Ended March 31, 2021, 2022 and 2023	F-44
Consolidated Statements of Changes in Shareholders' (Deficit)/Equity for the Years Ended March 31, 2021, 2022 and 2023	F-45
Consolidated Statements of Cash Flows for the Years Ended March 31, 2021, 2022 and 2023	F-46
Notes to the Consolidated Financial Statements	F-48

YS BIOPHARMA CO., LTD AND SUBSIDIARIES
CONDENSED CONSOLIDATED BALANCE SHEETS

	March 31, 2023	September 30, 2023	September 30, 2023
	(RMB)	(RMB)	(US\$)
		(Unaudited)	(Unaudited)
ASSETS			
Current assets			
Cash	370,108,059	259,905,532	\$ 36,199,550
Restricted cash	261,766	—	—
Accounts receivable, net	463,051,792	429,368,934	59,802,353
Advance to suppliers, net	6,763,326	21,168,706	2,948,370
Inventories, net	185,380,952	212,820,371	29,641,546
Prepaid expenses and other current assets	10,412,769	11,341,675	1,579,664
Total current assets	1,035,978,664	934,605,218	130,171,483
Non-current assets			
Property, plant and equipment, net	571,756,443	561,678,490	78,230,381
Operating lease right-of-use assets, net	11,132,428	9,607,109	1,338,075
Deferred tax assets, net	1,905,581	2,725,934	379,667
Intangible assets, net	78,056,792	74,638,356	10,395,604
Other assets, non-current	20,923,703	28,027,997	3,903,729
Total non-current assets	683,774,947	676,677,886	94,247,456
Total assets	1,719,753,611	1,611,283,104	\$ 224,418,939
LIABILITIES AND SHAREHOLDERS' EQUITY			
Current liabilities			
Bank loans and other borrowings – current	193,736,563	182,741,935	\$ 25,452,232
Accounts payable	80,439,489	84,978,140	11,835,725
Accrued expenses and other liabilities	377,536,644	388,071,992	54,050,530
Operating lease liabilities – current	4,753,547	5,027,649	700,249
Deferred government grants – current	2,295,701	2,295,701	319,744
Total current liabilities	658,761,944	663,115,417	92,358,480
Non-current liabilities			
Bank loans and other borrowings – non-current	293,790,596	361,965,073	50,414,367
Operating lease liabilities – non-current	6,348,890	4,462,505	621,536
Deferred government grants – non-current	23,606,507	22,458,657	3,128,034
Warrants liability	8,792,389	2,185,122	304,343
Total non-current liabilities	332,538,382	391,071,357	54,468,280
Total liabilities	991,300,326	1,054,186,774	146,826,760
Shareholders' equity			
Ordinary shares, par value US\$0.00002 per share; 9,950,000,000 shares authorized; 93,058,197 shares issued and outstanding;	12,297	12,297	1,713
Additional paid-in capital	2,656,891,036	2,656,891,036	370,050,842
Accumulated deficit	(1,874,037,965)	(2,048,560,763)	(285,322,817)
Accumulated other comprehensive loss	(54,412,083)	(51,246,240)	(7,137,559)
Total shareholders' equity	728,453,285	557,096,330	77,592,179
Total liabilities and shareholders' equity	1,719,753,611	1,611,283,104	\$ 224,418,939

The accompanying notes are an integral part of these condensed consolidated financial statements.

YS BIOPHARMA CO., LTD AND SUBSIDIARIES
UNAUDITED CONDENSED CONSOLIDATED STATEMENTS OF OPERATIONS AND
COMPREHENSIVE LOSS

	Six Months Ended September 30,		
	2022	2023	2023
	(RMB)	(RMB)	(US\$)
Revenues	399,534,723	273,092,454	\$ 38,036,220
Cost of revenues	93,700,779	52,187,142	7,268,607
Gross profit	305,833,944	220,905,312	30,767,613
Operating expenses:			
Selling and marketing	150,228,079	157,700,204	21,964,429
General and administrative	49,587,013	67,610,523	9,416,770
Research and development	123,861,107	178,853,200	24,910,610
Total operating expenses	323,676,199	404,163,927	56,291,809
Loss from operations	(17,842,255)	(183,258,615)	(25,524,196)
Other income (expenses):			
Late fees for social security insurance	(299,417)	(446,176)	(62,143)
Government grants	22,456,691	14,627,559	2,037,321
Interest income	266,433	1,957,620	272,657
Interest expense	(15,215,867)	(14,926,098)	(2,078,902)
Fair value changes of warrant liability	—	6,851,308	954,248
Other income (expense), net	74,675	(148,749)	(20,718)
Total other income, net	7,282,515	7,915,464	1,102,463
Loss before income taxes	(10,559,740)	(175,343,151)	(24,421,733)
Income tax (expense) benefit	(565,625)	820,353	114,258
Net loss	(11,125,365)	(174,522,798)	(24,307,475)
Accretion to redemption value of convertible redeemable preferred shares	(72,083,238)	—	—
Net loss attributable to YS Group	(83,208,603)	(174,522,798)	\$ (24,307,475)
Net loss	(11,125,365)	(174,522,798)	\$ (24,307,475)
Other comprehensive (loss) income: foreign currency translation adjustment	(168,653,952)	3,165,843	440,937
Total comprehensive loss	(179,779,317)	(171,356,955)	\$ (23,866,538)
Loss per share*:			
– Basic and Diluted	(0.18)	(1.88)	\$ (0.26)
Weighted average number of ordinary shares outstanding*:			
– Basic and Diluted	61,785,466	93,058,197	93,058,197

* Gives retroactive effect to reflect the reorganization in February 2021 and business combination in March 2023.

The accompanying notes are an integral part of these condensed consolidated financial statements.

YS BIOPHARMA CO., LTD AND SUBSIDIARIES
UNAUDITED CONDENSED CONSOLIDATED STATEMENTS OF CHANGES IN SHAREHOLDERS'
(DEFICIT)/EQUITY

Six Months Ended September 30,						
	Ordinary shares		Additional paid-in capital	Accumulated Deficit	Accumulated other comprehensive loss	Total stockholders' Equity
	Shares	Amount				
	(RMB)	(RMB)	(RMB)	(RMB)	(RMB)	(RMB)
Balance as of March 31, 2023	93,058,197	12,297	2,656,891,036	(1,874,037,965)	(54,412,083)	728,453,285
Net loss				(174,522,798)		(174,522,798)
Foreign currency translation adjustment					3,165,843	3,165,843
Balance as of September 30, 2023 (in RMB) (unaudited)	93,058,197	12,297	2,656,891,036	(2,048,560,763)	(51,246,240)	557,096,330
Balance as of September 30, 2023 (In US\$) (unaudited)	93,058,197	1,713	370,050,842	(285,322,817)	(7,137,559)	77,592,179

Six Months Ended September 30,						
	Ordinary shares*		Additional paid-in capital	Accumulated Deficit	Accumulated other comprehensive income/(loss)	Total stockholders' deficit
	Shares	Amount				
	(RMB)	(RMB)	(RMB)	(RMB)	(RMB)	(RMB)
Balance as of March 31, 2022	61,827,884	7,978	808,502,018	(1,590,567,163)	83,087,979	(698,969,188)
Accretion to redemption value of convertible redeemable preferred shares	—	—	—	(72,083,238)	—	(72,083,238)
Net loss	—	—	—	(11,125,365)	—	(11,125,365)
Share-based compensation	(143,750)	—	(85,316)	—	—	(85,316)
Foreign currency translation adjustment	—	—	231,807	—	(168,653,952)	(168,422,145)
Balance as of September 30, 2022 (in RMB) (unaudited)	61,684,134	7,978	808,648,509	(1,673,775,766)	(85,565,973)	(950,685,252)
Balance as of September 30, 2022 (In US\$) (unaudited)	61,684,134	1,124	113,897,365	(235,749,706)	(12,051,884)	(133,903,101)

* Gives retroactive effect to reflect the reorganization in February 2021 and business combination in March 2023.

The accompanying notes are an integral part of these condensed consolidated financial statements.

YS BIOPHARMA CO., LTD AND SUBSIDIARIES
UNAUDITED CONDENSED CONSOLIDATED STATEMENTS OF CASH FLOWS

	Six Months Ended September 30,		
	2022	2023	2023
	(RMB)	(RMB)	(US\$)
Cash flows from operating activities:			
Net loss	(11,125,365)	(174,522,798)	\$ (24,307,475)
Adjustments to reconcile net loss to net cash used in operating activities:			
Deferred income taxes	565,625	(820,353)	(114,258)
Depreciation of property, plant and equipment	13,818,386	16,514,915	2,300,192
Amortization of intangible assets	3,409,643	3,418,436	476,119
Loss on disposal of property, plant and equipment	64,179	—	—
Share-based compensation	(85,316)	—	—
Bad debt provision of accounts receivable	6,447,109	5,341,696	743,990
Write-down of inventories to net realizable value	—	10,678,694	1,487,325
Non-cash lease expense	2,409,286	2,452,349	341,562
Fair value changes of warrant liability	—	(6,851,308)	(954,248)
Changes in operating assets and liabilities:			
Inventories	4,838,379	(38,118,113)	(5,309,077)
Accounts receivable	(166,251,393)	28,341,162	3,947,347
Prepaid expenses and other current assets	4,102,924	(22,438,580)	(3,125,237)
Accounts payable	6,583,078	4,538,651	632,142
Accrued expenses and other liabilities	37,289,942	29,330,997	4,085,211
Deferred government grants	(8,026,551)	(1,147,850)	(159,872)
Operating lease liabilities	(1,435,079)	(2,549,633)	(355,112)
Net cash used in operating activities	(107,395,153)	(145,831,735)	(20,311,391)
Cash flows from investing activities:			
Proceeds from disposal of property, plant and equipment	—	155,191	21,615
Purchases of property, plant and equipment	(15,017,753)	(23,576,885)	(3,283,780)
Purchases of intangible assets	(4,006,598)	—	—
Net cash used in investing activities	(19,024,351)	(23,421,694)	(3,262,165)
Cash flows from financing activities:			
Proceeds from bank loans and other borrowings	102,513,927	201,211,920	28,024,725
Repayment of bank loans and other borrowings	(50,606,602)	(156,356,071)	(21,777,218)
Net cash provided by financing activities	51,907,325	44,855,849	6,247,507
Effect of foreign exchange rate on cash	30,471,942	13,933,287	1,940,621
Net decrease in cash	(44,040,237)	(110,464,293)	(15,385,428)
Cash at the beginning of the period	271,067,503	370,369,825	51,584,978
Cash at the end of the period	227,027,266	259,905,532	\$ 36,199,550
Reconciliation of cash and restricted cash			
Cash	226,765,500	259,905,532	36,199,550
Restricted cash	261,766	—	—
Total cash and restricted cash shown in the statements of cash flows	227,027,266	259,905,532	36,199,550
Supplemental disclosures of cash flow information:			
Interest paid	12,723,051	10,132,047	\$ 1,411,188
Non-cash transactions:			
Accretion to redemption value of convertible redeemable preferred shares	72,083,238	—	\$ —
Operating right-of-use assets recognized for related operating lease liabilities	—	811,094	\$ 112,969

The accompanying notes are an integral part of these condensed consolidated financial statements.

YS BIOPHARMA CO., LTD AND SUBSIDIARIES
NOTES TO THE CONDENSED CONSOLIDATED FINANCIAL STATEMENTS
September 30, 2023 and March 31, 2023

NOTE 1 — ORGANIZATION AND BUSINESS DESCRIPTION

YS Biopharma Co., Ltd (“YS Biopharma”), formerly known as Yisheng Bio Co., Ltd (with the name changed March 16, 2023), was incorporated under the laws of the Cayman Islands as an exempted company with limited liability in November 2020. It owns five companies and their subsidiaries that were incorporated in the Cayman Islands, United States of America (“US”), Singapore, Philippines, Hong Kong and the People’s Republic of China (“China” or the “PRC”) (collectively, the “Company” or “YS Group”). YS Group is principally engaged in the research, development, manufacturing and sale of vaccines and therapeutic biologics. It developed a PIKA immunomodulating technology platform and a series of product candidates targeting rabies, hepatitis B, influenza and other indications. It is also conducting the production and sale of YSJA™ (依生君安™) rabies vaccine, the first aluminum-free lyophilized rabies vaccine launched in China.

Business Combination

On August 15, 2022, Oceanview Bioscience Acquisition Co., Ltd. (“Oceanview Bioscience”) and Hudson Biomedical Group Co., Ltd. (“Hudson Biomedical”) were incorporated under the laws of Cayman Islands as exempted companies with limited liability. The companies were incorporated effect to a merger with Summit Healthcare Acquisition Corp, a Special Purpose Acquisition Company (“SPAC”). YS Group’s legal entity structure was as follows:

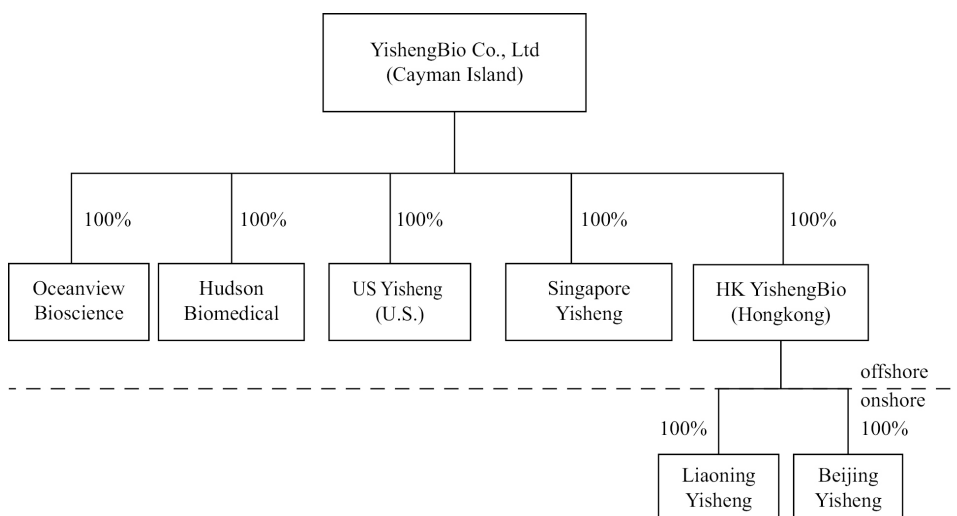

On September 29, 2022, YS Biopharma entered into the Business Combination Agreement with Summit Healthcare Acquisition Corp (“Summit”), Oceanview Bioscience Acquisition Co., Ltd., (“Merger Sub I”) and Hudson Biomedical Group Co., Ltd., (“Merger Sub II”). The Business Combination Agreement provides for (1) the merger of Merger Sub I with and into Summit (the “First Merger”), with Summit surviving the First Merger as the surviving entity (the “Surviving Entity”) and becoming a wholly-owned subsidiary of YS Biopharma, and (2) the merger of the Surviving Entity with and into Merger Sub II (the “Second Merger,” and together with the First Merger, the “Mergers,” together with other transactions contemplated by the Business Combination Agreement, the “Business Combination”), with Merger Sub II surviving the Second Merger as the surviving company (the “Surviving Company”) and remaining as a wholly-owned subsidiary of YS Biopharma.

In accordance with the Business Combination Agreement, on the date of closing of the Mergers (“First Merger and Second Merger”), (1) each YS Biopharma’s preferred share was converted into one pre-consolidation Ordinary Share;

YS BIOPHARMA CO., LTD AND SUBSIDIARIES
NOTES TO THE CONDENSED CONSOLIDATED FINANCIAL STATEMENTS
September 30, 2023 and March 31, 2023

NOTE 1 — ORGANIZATION AND BUSINESS DESCRIPTION (cont.)

(2) every four of the pre-consolidation Ordinary Shares and every four pre-consolidation options of YS Biopharma was consolidated into one Ordinary Share and one option of YS Biopharma, respectively, subject to rounding up to the nearest whole number of Ordinary Shares.

On March 16, 2023 (the “Closing Date”), YS Biopharma announced the completion of its business combination with Summit pursuant to the above Business Combination Agreement.

On May 9, 2023, YS Biopharma (Philippines) Inc. (“Philippines Yisheng”) was incorporated under the laws of Philippines as an entity owned by YS Group. Philippines Yisheng was incorporated for the purpose of research, development, producing, wholesaling and commercializing pharmaceutical products, including vaccines and other biological products.

YS Group’s current legal entity structure is as follows:

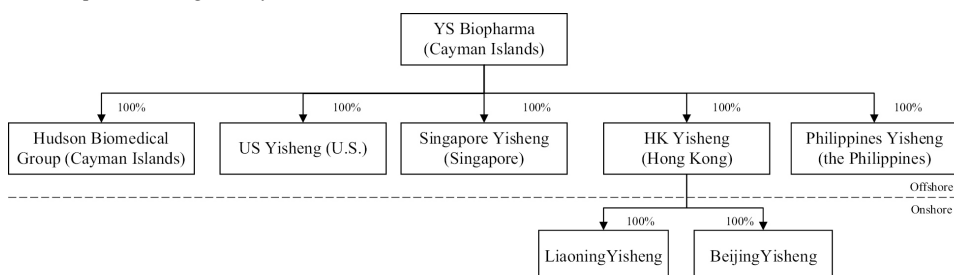

As of September 30, 2023, YS Group consists of the following legal entities:

Legal Entity	Nature of Operations	Date of Incorporation	Place of Incorporation
YS Biopharma Co., Ltd. (“YS Biopharma”)**	Holding Company	November 16, 2020	Cayman Islands
YishengBio (Hong Kong) Holdings Limited (“HK Yisheng”)	Holding Company	December 28, 2020	Hong Kong
Yisheng Biopharma (Singapore) Pte. Ltd. (“Singapore Yisheng”)**	Research and development of vaccines and therapeutic biologics	November 28, 2009	Singapore
Yisheng US Biopharma Inc. (“US Yisheng”)	Research of vaccines and therapeutic biologics	September 29, 2009	US
Liaoning Yisheng Biopharma Co., Ltd. (“Liaoning Yisheng”)*	Research and development, manufacturing and commercialization of vaccines and therapeutic biologics	May 26, 1994	PRC
Beijing Yisheng Biotechnology Co., Ltd. (“Beijing Yisheng”)	Research and development of vaccines and therapeutic biologics	February 4, 2021	PRC
Hudson Biomedical Group Co., Ltd.	Purpose of effecting a merger	August 15, 2022	Cayman Islands
YS Biopharma (Philippines) Inc. (“Philippines Yisheng”)	Researching, developing, producing, wholesaling and commercializing pharmaceutical products	May 9, 2023	Philippines

* Liaoning Yisheng was incorporated May 26, 1994, and acquired by YS Group in fiscal 2005.

** Singapore Yisheng was incorporated November 28, 2009, and acquired by YS Group in fiscal 2011

*** YS Biopharma, formerly known as Yisheng Bio Co., Ltd with the name changed on March 16, 2023.

YS BIOPHARMA CO., LTD AND SUBSIDIARIES
NOTES TO THE CONDENSED CONSOLIDATED FINANCIAL STATEMENTS
September 30, 2023 and March 31, 2023

NOTE 2 — LIQUIDITY

As reflected in the unaudited condensed accompanying consolidated financial statements (“CFS”), the Company reported net loss of RMB174,522,798 and RMB11,125,365 for the six months ended September 30, 2023 and 2022, respectively. And the Company reported accumulated deficit of RMB2,048,560,763 and RMB1,874,037,965 (audited) as of September 30, 2023 and March 31, 2023.

In assessing its liquidity, management monitors and analyzes the Company’s cash flow requirements, its ability to generate revenue in the future, and its operating and capital expenditure commitments. As of September 30, 2023, the Company had cash of approximately RMB259.9 million (US\$36.2 million). As of September 30, 2023, the Company had outstanding bank loans and other borrowings of approximately RMB544.7 million (US\$75.9 million) from various financial institutions.

On December 27, 2023, HK Yisheng received a letter from R-Bridge (the “R-Bridge Letter”), notifying the Company that they have reason to believe that HK Yisheng has defaulted under financial covenants and other obligations under the facility agreement, and under the instructions of the lenders to urge the Company to consider and reach an amicable solution with the lenders, including, without limitation, repaying the loan in full, as soon as possible. In response to the R-Bridge Letter, management has provided the financial information to R-Bridge at its request and is currently working with the lenders under the facility agreement to negotiate a resolution. Management believes that, our current cash position, coupled with various measures being taken by us, such as increase product sales, strengthen the accounts receivable management and improve the ability of debt and equity financing to improve liquidity, will allow us to meet the working capital needs in the ordinary course of business. However, if lenders under the facility agreement are not satisfied and insist that we have defaulted under the facility agreement, such lenders may declare that all or part of the loan, the accrued interest, and all other amounts accrued or outstanding be immediately due and payable. If such lenders demand the prepayment of the loan in its full amount of \$40 million, the Company may be forced to seek additional funding to meet its obligation under the facility agreement, otherwise it may not be able to continue as a going concern.

NOTE 3 — SUMMARY OF SIGNIFICANT ACCOUNTING POLICIES

Basis of Presentation

The accompanying unaudited interim condensed CFS of YS Group were prepared in accordance with the accounting principles generally accepted in the United States of America (“U.S. GAAP”) and applicable rules and regulations of the Securities and Exchange Commission (“SEC”). These unaudited interim condensed CFS do not include all the information and footnotes required by U.S. GAAP for annual financial statements.

In the opinion of YS Group’s management, the accompanying unaudited interim condensed CFS contain all normal recurring adjustments necessary to present fairly the financial position, operating results and cash flows of YS Group for each of the periods presented. The results of operations for the six months ended September 30, 2023 are not necessarily indicative of results to be expected for any other interim periods or for the year ending March 31, 2024. These unaudited interim condensed CFS should be read in conjunction with YS Group’s audited CFS for the years ended March 31, 2023 and 2022.

Basis of Consolidation

The CFS include the financial statements of YS Group and its wholly-owned subsidiaries. All significant intercompany transactions and balances were eliminated in consolidation. The CFS were prepared on a historical cost basis, except for financial assets and financial liabilities which were measured at fair value (“FV”). The functional currency of YS Group and its Hong Kong subsidiary, US subsidiary is the United States dollars (“US\$”). The functional currency of YS Group’s Singapore subsidiary is the Singapore dollars (“S\$”). The functional currency of YS Group’s PRC subsidiaries is the Chinese Renminbi (“RMB”). The functional currency of YS Group’s Philippines subsidiary is the Philippine Peso. The determination of functional currency is based on the criteria of Accounting Standard Codifications (“ASC”) as promulgated by the Financial Accounting Standards Board, ASC 830, Foreign Currency Matters (“ASC 830”). YS Group uses the RMB as its reporting currency.

YS BIOPHARMA CO., LTD AND SUBSIDIARIES
NOTES TO THE CONDENSED CONSOLIDATED FINANCIAL STATEMENTS
September 30, 2023 and March 31, 2023

NOTE 3 — SUMMARY OF SIGNIFICANT ACCOUNTING POLICIES (cont.)***Use of Estimates***

The preparation of the CFS in conformity with U.S. GAAP requires management to make estimates and assumptions that affect the reported amounts of assets and liabilities and disclosure of contingent assets and liabilities at the date of the CFS and the reported amounts of revenues and expenses during the reporting periods. Significant estimates and assumptions reflected in these CFS include, but are not limited to, the valuation of YS Group's convertible redeemable preferred shares and ordinary shares, accrual of stock-based compensation expense, allowance for doubtful accounts and obsolete inventories, useful life of property, plant and equipment, income taxes and uncertain tax positions. Actual amounts could differ from those estimates. Changes in estimates are recorded in the period when they become known. Due to the risks and uncertainties involved in YS Group's business and evolving market conditions and, given the subjective element of the estimates and assumptions made, actual results may differ from estimated results.

Foreign Currency Translation

YS Group's CFS are reported using the RMB. The results of operations and the consolidated statements of cash flows denominated in foreign currency are translated at the average rate of exchange during the reporting period. Assets and liabilities denominated in foreign currencies at the balance sheet date are translated at the applicable rates of exchange in effect at that date. The equity denominated in the functional currency is translated at the historical rate of exchange at the time of capital transaction. Because cash flows are translated based on the average translation rate, amounts related to assets and liabilities reported on the consolidated statements of cash flows will not necessarily agree with changes in the corresponding balances on the consolidated balance sheets. Foreign currency translation adjustments arising from the use of different exchange rates from period to period are included as a separate component of accumulated other comprehensive income included in YS Group's consolidated statements of changes in shareholders' equity. Gains and losses from foreign currency transactions are included in YS Group's consolidated statements of operations and comprehensive loss.

The value of RMB against US\$ and other currencies may fluctuate and is affected by, among other things, changes in the PRC's political and economic conditions. The following table outlines the currency exchange rates used in preparing YS Group's CFS:

	March 31, 2023	September 30, 2023	Six Months Ended September 30,	
			2022	2023
Foreign currency	Balance Sheet	Balance Sheet	Profit/Loss	Profit/Loss
RMB:1US\$	6.8717	7.1798	6.7240	7.0258
RMB:1S\$	5.1760	5.2599	4.8325	5.2180
RMB:1Peso	0.1264	0.1286	0.1217	0.1275

Convenience translation

Amounts in US\$ are presented for the convenience of the reader and translated at US\$1.00 to RMB7.1798, the central parity rate release of the People's Bank of China on September 30, 2023. No representation is made that the RMB amounts could have been, or converted, realized or settled into US\$ at such rate.

Cash

Cash includes cash on hand and demand deposits in accounts maintained with commercial banks. YS Group maintains bank accounts in China. Cash balances in bank accounts in China are not insured by the Federal Deposit Insurance Corporation or other programs.

Restricted Cash

Restricted cash balances mainly relate to restrictions imposed on banks as cash deposits for the issuance of letters of credit. And it is included in the total cash, cash equivalents, and restricted cash in the consolidated statements of cash flows.

YS BIOPHARMA CO., LTD AND SUBSIDIARIES
NOTES TO THE CONDENSED CONSOLIDATED FINANCIAL STATEMENTS
September 30, 2023 and March 31, 2023

NOTE 3 — SUMMARY OF SIGNIFICANT ACCOUNTING POLICIES (cont.)

Accounts Receivable, net

Accounts receivable is presented net of allowance for doubtful accounts. YS Group reduces its accounts receivable by recording a bad debt allowance to account for the estimated impact of collection issues resulting from a customer's inability or unwillingness to pay valid obligations to YS Group. YS Group determines the adequacy of allowance for doubtful accounts based on individual account analysis, historical collection trend, and best estimate of specific losses on individual exposures. YS Group establishes an allowance for doubtful accounts when there is objective evidence that YS Group may not be able to collect amounts due. Accounts receivable balances are written off after all collection efforts have been exhausted.

Advance to Suppliers, net

Advance to suppliers are amounts advanced to vendors or suppliers for providing raw materials to YS Group. The suppliers usually require advance payments when YS Group orders materials and the advance will be utilized to offset YS Group's actual payment obligations. These amounts advanced are unsecured, non-interest bearing and generally short term in nature. YS Group will reduce its advance to suppliers by recording an allowance that approximates the extent of the advance that may not be realizable during the procurement process. YS Group recorded RMB100 and RMB54,870 allowance against its advance to suppliers as of September 30, 2023 and March 31, 2023 it is audited.

Inventories, net

Inventories are stated at the lower of cost or net realizable value. Cost is determined on the weighted average basis and comprises all cost of purchase and other costs incurred in bringing the inventories to their present location and condition. Net realizable value is based on estimated selling prices less any estimated costs to be incurred to completion and disposal.

YS Group reviews the carrying amounts of inventories quarterly to determine if the inventories are carried at lower of cost or net realizable value. The net realizable value is estimated based on current market conditions and historical experience.

Adjustments are recorded to write down the cost of inventory based on the expiration date of raw materials and the estimate of future usage. Write-downs are recorded in cost of revenue in the consolidated statements of operations and comprehensive loss.

Property, Plant and Equipment, net

Property, plant and equipment are stated at cost less accumulated depreciation and any impairment losses. The cost of property, plant and equipment comprises its purchase price and any directly attributable costs of bringing the asset to its working condition and location for its intended use.

Expenditure incurred after items of property, plant and equipment have been put into operation, such as repairs and maintenance, are expensed when incurred. In situations where the recognition criteria are satisfied, the expenditure for a major reconstruction is capitalized as a replacement. Where significant parts of property, plant and equipment are required to be replaced at intervals, YS Group recognizes such parts as individual assets with specific useful lives and depreciates them accordingly.

Depreciation is calculated on the straight-line basis to reduce the cost of each item of property, plant and equipment to its residual value over its estimated useful life.

Category	Estimated useful life
Plant and building	6 – 20 years
Machinery and equipment	5 – 10 years
Furniture and fixtures	3 – 7 years
Motor vehicle	4 – 5 years
Leasehold improvement	Lesser of the lease term or life of assets

YS BIOPHARMA CO., LTD AND SUBSIDIARIES
NOTES TO THE CONDENSED CONSOLIDATED FINANCIAL STATEMENTS
September 30, 2023 and March 31, 2023

NOTE 3 — SUMMARY OF SIGNIFICANT ACCOUNTING POLICIES (cont.)

Where parts of an item of property, plant and equipment have different useful lives, the cost of that item is allocated on a reasonable basis among the parts and each part is depreciated separately. Residual values, useful lives and the depreciation method are reviewed, and adjusted if appropriate, at least at each quarter end.

An item of property, plant and equipment including any significant part initially recognized is derecognized upon disposal or when no future economic benefits are expected from its use or disposal. Any gain or loss on disposal or retirement recognized in the statement of operations in the period the asset is derecognized is the difference between the net sales proceeds and the carrying amount of the relevant asset.

Intangible assets, net

Intangible assets acquired separately are measured on initial recognition at cost. The cost of intangible assets acquired in a business combination is the FV at the date of acquisition. The useful lives of intangible assets are assessed to be either finite or indefinite. Intangible assets with finite lives are amortized over the useful economic life and assessed for impairment whenever there is an indication that the intangible asset may be impaired. The amortization period and method for an intangible asset with a finite useful life is reviewed for appropriateness at each financial year end.

Intangible assets with indefinite useful lives or not yet available for use are tested for impairment annually either individually or at the cash-generating unit level. Such intangible assets, including vaccine license and patent with indefinite useful lives, are not amortized. The useful life of an intangible asset with an indefinite life is reviewed annually to determine whether the indefinite life assessment continues to be supportable. If not, the change in the useful life assessment from indefinite to finite is accounted for on a prospective basis.

Patents with definite useful lives are stated at cost less any impairment losses and are amortized on the straightline basis over their estimated useful lives of 15 years. Software and laboratory information system are amortized on the straight-line basis over their estimated useful lives of 10 years.

An intangible asset determined to have an indefinite useful life is not amortized until its useful life is determined to be no longer indefinite. Management evaluates the remaining useful life of an intangible asset that is not amortized in each reporting period to determine whether events and circumstances continue to support an indefinite useful life. Indefinite-lived intangible assets are subject to impairment testing at least annually.

Management believes YS Group's Drug Manufacturing License granted by the Liaoning Food and Drug Administration ("FDA") is an intangible asset with an indefinite useful life because the certificate may be renewed indefinitely at little cost and has historically been renewed by Liaoning Yisheng. Liaoning Yisheng intends to renew the certificate indefinitely, and has the ability to do so. Cash flows from the certificate are expected to continue indefinitely. Therefore, the Drug Manufacturing License is not amortized until its estimated useful life is believed to be no longer indefinite.

All research and development costs are expensed as incurred. Expenditure incurred on projects to develop new products is capitalized and deferred only when YS Group can demonstrate the technical feasibility of completing the intangible asset so that it will be available for use or sale, its intention to complete and its ability to use or sell the asset, how the asset will generate future economic benefits, the availability of resources to complete the project and the ability to measure reliably the expenditure during the development. Product development expenditures which do not meet these criteria are expensed when incurred.

Land use rights: Land lease payments are amounts paid for the rights to use land in the PRC and are recorded net of accumulated amortization. Amortization is provided on a straight-line basis over the term of the lease agreement, which ranges from 48.75 to 50 years.

YS BIOPHARMA CO., LTD AND SUBSIDIARIES
NOTES TO THE CONDENSED CONSOLIDATED FINANCIAL STATEMENTS
September 30, 2023 and March 31, 2023

NOTE 3 — SUMMARY OF SIGNIFICANT ACCOUNTING POLICIES (cont.)***Impairment of Long-lived Assets***

YS Group reviews long-lived assets, including definitive-lived intangible assets and property and equipment, for impairment whenever events or changes in circumstances indicate the carrying amount of an asset may not be recoverable. When such events occur, YS Group assesses the recoverability of the asset group based on the undiscounted future cash flows the asset group is expected to generate and recognizes an impairment loss when estimated undiscounted future cash flows expected to result from the use of the asset group plus net proceeds expected from disposition of the asset group, if any, is less than the carrying value of the asset group. If YS Group identifies an impairment, YS Group reduces the carrying amount of the asset group to its estimated FV based on a discounted cash flow approach or, when available and appropriate, to comparable market values and the impairment loss, if any, is recognized in general and administrative expenses in the consolidated statements of operations. YS Group uses estimates and judgments in its impairment tests and if different estimates or judgments had been utilized, the timing or the amount of any impairment charges could be different. Asset groups to be disposed of would be reported at the lower of the carrying amount or FV less costs to sell, and no longer depreciated. YS Group did not record any impairment charges during the six months ended September 30, 2023 or 2022.

Concentrations of Credit Risk and Significant Suppliers

Financial instruments that potentially subject YS Group to concentration of credit risk consist of cash. YS Group mitigates this risk by maintaining its cash with high quality, accredited financial institutions. As of September 30, 2023, YS Group's cash was deposited at more than two financial institutions and it did not have any foreign currency exchange contracts, option contracts or other hedging arrangements. YS Group has not experienced any losses on its deposits of cash and does not believe that it is exposed to any unusual credit risk beyond the normal credit risk associated with commercial banking relationships.

YS Group's sales are made primarily to Centers for Disease Control and Prevention ("CDCs") located in China. YS Group does not have a concentration of its revenue and accounts receivable with specific customers. As of September 30, 2023 and March 31, 2023, there was no customer which accounted for more than 10% of YS Group's accounts receivable balance. During the six months ended September 30, 2023 and 2022, there were no customers that accounted for more than 10% of YS Group's net revenues.

Details of percentage of YS Group's top five vendors accounting for total purchases are as follows:

	Six Months Ended September 30, 2023		
	(RMB)	(US\$)	
Vendor F	26,744,400	\$ 3,724,951	28.8%
Vendor B	9,544,080	1,329,296	10.3%
Vendor G	5,844,185	813,976	6.3%
Vendor D	5,074,866	706,826	5.5%
Vendor H	4,799,409	668,460	5.2%
Total	52,006,940	\$ 7,243,509	56.1%

	Six Months Ended September 30, 2022		
	(RMB)	(US\$)	
Vendor A	21,661,500	\$ 3,051,001	38.8%
Vendor B	10,053,600	1,416,040	18.0%
Vendor C	3,005,828	423,368	5.4%
Vendor D	2,009,315	283,010	3.6%
Vendor E	1,859,500	261,909	3.3%
Total	38,589,743	\$ 5,435,328	69.1%

YS BIOPHARMA CO., LTD AND SUBSIDIARIES
NOTES TO THE CONDENSED CONSOLIDATED FINANCIAL STATEMENTS
September 30, 2023 and March 31, 2023

NOTE 3 — SUMMARY OF SIGNIFICANT ACCOUNTING POLICIES (cont.)

YS Group's business operation has been, and may continue to be, negatively affected by the outbreak of COVID-19. While many of the restrictions on movements within China have been relaxed, there is great uncertainty around the future of the COVID-19 outbreak and how it will impact YS Group's operations. If the outbreak persists or escalates, YS Group may be subject to further negative impact on business operations and financial condition.

Fair Value Measurements

ASC 825-10 requires certain disclosures regarding the FV of financial instruments. FV is defined as the price that would be received to sell an asset or paid to transfer a liability in an orderly transaction between market participants at the measurement date. A three-level FV hierarchy prioritizes the inputs used to measure FV. The hierarchy requires entities to maximize the use of observable inputs and minimize the use of unobservable inputs. The three levels of inputs used to measure FV are as follows:

- Level 1 — inputs to the valuation methodology are quoted prices (unadjusted) for identical assets or liabilities in active markets.
- Level 2 — inputs to the valuation methodology include quoted prices for similar assets and liabilities in active markets, quoted market prices for identical or similar assets in markets that are not active, inputs other than quoted prices that are observable and inputs derived from or corroborated by observable market data.
- Level 3 — inputs to the valuation methodology are unobservable.

Unless otherwise disclosed, the FV of YS Group's financial instruments including cash, accounts receivable, advances to suppliers, amounts due from related parties, prepaid expenses and other current assets, short-term bank loans and other loans, accounts payable, warrant liabilities, and accrued expenses and other current liabilities approximate their recorded values due to their short-term maturities. The FV of longer-term leases approximates their recorded values as their stated interest rates approximate the rates currently available.

YS Group's non-financial assets, such as property and equipment would be measured at FV only if they were determined to be impaired.

Social Security Insurance

Employees of YS Group's subsidiaries that operate in the PRC are required to participate in a pension scheme operated by the local municipal government. According to the Social Insurance Law of the PRC (the "Social Security Insurance Law") promulgated by the Standing Committee of the National People's Congress (the "Standing Committee") that became effective on December 29, 2018, there are five basic types of social security insurance, which include: basic pension, basic medical, unemployment, work-related injury and maternity insurance (collectively known as "social security insurance"). Both employees and employers make contributions for the first three kinds of social security insurance; and only employers make contributions for the latter two kinds, which means the employers must pay all or a portion of the social security insurance premiums for their employees. If the YS Group does not comply with the relevant requirements and does not make social insurance contributions in full to the social insurance scheme for the employees of PRC affiliated entities, the YS Group will be required to make up the social insurance contributions as well as to pay late fees at 0.05% per day of the outstanding amount from the due date. If the YS Group fails to make up for the shortfalls within the prescribed time limit, the relevant administrative authorities could impose a fine of one to three times the outstanding amount and file applications to competent courts for compulsory enforcement of payment and deposit. No fine or compulsory enforcement had been imposed by relevant authorities in connection with the delayed payment of the social security insurance premiums by the YS Group. As of September 30, 2023 and March 31, 2023, YS Group's recorded late fees of RMB10.2 million and RMB9.9 million, respectively, for its liabilities related to social security insurance (see Note 11). During six months ended September 30, 2023 and 2022, YS Group's recognized late fees for social security insurance were approximately, RMB0.4 million and RMB0.3 million, respectively.

YS BIOPHARMA CO., LTD AND SUBSIDIARIES
NOTES TO THE CONDENSED CONSOLIDATED FINANCIAL STATEMENTS
September 30, 2023 and March 31, 2023

NOTE 3 — SUMMARY OF SIGNIFICANT ACCOUNTING POLICIES (cont.)

Leases

Under ASC Topic 842, Leases (“ASC 842”), YS Group determines if an arrangement is or contains a lease at inception. For leases with a term of 12 months or less, YS Group does not recognize a right-of-use (“ROU”) asset or lease liability. YS Group’s operating leases are recognized on its consolidated balance sheets as noncurrent assets, current liabilities and noncurrent liabilities. YS Group does not have any finance leases.

ROU assets represent YS Group’s right to use an underlying asset for the lease term and lease liabilities represent YS Group’s obligation to make lease payments arising from the lease. Operating lease ROU assets and liabilities are recognized at the lease commencement date based on the present value of lease payments over the lease term. As YS Group’s leases typically do not provide an implicit rate, YS Group uses an estimate of its incremental borrowing rate based on the information available at the lease commencement date in determining the present value of lease payments. The lease terms may include options to extend or terminate the lease when it is reasonably certain that YS Group will exercise that option. Lease expense is recognized on a straight-line basis over the lease term. For leases with terms greater than 12 months, YS Group records the related asset and lease liability at the present value of lease payments over the lease term. For leases with terms less than 12 months, YS Group records rents in general and administrative expenses.

Government Grants

Government grants are primarily subsidies received from PRC governments for operating a business in their jurisdictions and in compliance with specific policies promoted by the government authorities. YS Group’s PRC-based subsidiaries received specific subsidies and other subsidies from certain local governments. Specific subsidies are subsidies the local government sets certain conditions. Other subsidies are subsidies the local government has not set any conditions and are not tied to future trends or performance of YS Group, receipt of such subsidy is not contingent upon any further actions or performance of YS Group and the amounts do not have to be refunded under any circumstances. Specific subsidies are recorded as deferred government grants upon receipt and are recognized as government grants in income when the conditions are met. Other subsidies are recognized as other income upon receipt as further performance by YS Group is not required.

Government grants for research and development (“R&D”) are recognized as a reduction to R&D expenses when the conditions attached to the grants are met or recognized as government grants recognized in income in the period when the conditions are met after the expenses are incurred. Government grants for property, plant and equipment are deferred and recognized as a reduction to the related depreciation and amortization expenses in the same manner as the property, plant and equipment are depreciated.

Warrants

YS Group accounts for warrants as either equity-method or liability-method instruments based on an assessment of the warrant’s specific terms and applicable authoritative guidance in ASC 480 and ASC 815. Warrants recorded as equity are recorded at their relative FV determined at the issuance date and remeasurement is not required. Warrants recorded as liabilities are recorded at their FV, within warrant liabilities on the consolidated balance sheets and are remeasured on each reporting date with changes recorded in FV changes of warrant liabilities on the consolidated statements of operations and comprehensive loss.

Upon consummation of the Business Combination, each Summit Warrant outstanding ceased to be a warrant with respect to Summit Public Shares and was assumed by YS Biopharma and converted into a YS Biopharma Warrant entitling the holder thereof to purchase such number of Ordinary Share on a one-on-one basis. After the merger with Summit, the Company accounts for the 10,750,000 public warrants as equity and 6,000,000 private warrants as liabilities.

YS BIOPHARMA CO., LTD AND SUBSIDIARIES
NOTES TO THE CONDENSED CONSOLIDATED FINANCIAL STATEMENTS
September 30, 2023 and March 31, 2023

NOTE 3 — SUMMARY OF SIGNIFICANT ACCOUNTING POLICIES (cont.)

Revenue from Contracts with Customers

YS Group follows ASC 606 — “Revenue from Contracts with Customers” for all periods presented. ASC 606 established principles for reporting information about the nature, amount, timing, and uncertainty of revenue and cash flows arising from our contracts to provide services to customers. Based on the following five steps analysis, revenues from contracts with customers are recognized when control of the promised goods or services is transferred to the customers, in an amount that reflects the consideration YS Group expects to be entitled in exchange for those goods or services.

Step 1: Identify the contract with the customer;

Step 2: Identify the performance obligations in the contract;

Step 3: Determine the transaction price;

Step 4: Allocate the transaction price to the performance obligations in the contract; and

Step 5: Recognize revenue when YS Group satisfies a performance obligation

YS Group is principally engaged in the research, development, manufacturing and sale of vaccines and therapeutic biologics. YS Group’s revenues primarily streams from the sales of vaccines.

The core principle underlying revenue recognition in ASC 606 is that YS Group recognizes revenue for the transfer of vaccines to customers in an amount that reflects the consideration to which YS Group expects to be entitled. This requires YS Group to identify contractual performance obligations and determine whether revenue should be recognized at a point in time or over time. YS Group’s sales contracts of vaccines have one performance obligation that is to sell vaccines to the customers. The sales contracts with customers do not involve variable considerations, such as discounts and rebates. And according to the historical operation, circumstance of discounts and rebates have never occurred. The customer pays after acceptance of the vaccines. According to ASC 606, the relevant revenue recognition is based on customer acceptance confirmation.

In accordance with ASC606-10-55-36 through 55-40, YS Group evaluates whether it is appropriate to record the gross amount of vaccines and related costs or the net amount earned as commissions. When the entity is a principal, that the entity obtains control of the specified goods or services before they are transferred to the customers, the revenues should be recognized in the gross amount of consideration to which it expects to be entitled in exchange for the specified goods or services transferred. When the entity is an agent and its obligation is to facilitate third parties in fulfilling their performance obligation for specified goods or services, the revenues should be recognized in the net amount for the amount of commission which the entity earns in exchange for arranging for the specified goods or services to be provided by other parties. Revenues are recorded net of value-added taxes. YS Group sells vaccines to the customers, and it obtains control of the vaccines before customer acceptance confirmation. Therefore, YS Group is a principal, and the revenues are recognized according to the gross method.

Cost of Revenues

Cost of revenues consists primarily of the cost of merchandise sold and write-down of slow-moving or obsolete inventories.

General and Administrative Expenses

General and administrative expenses consist mainly of payroll and related costs for employees involved in general corporate functions, including accounting, finance, tax, legal and human resources, professional fees, and provision for bad debts, value-added taxes and other general corporate expenses as well as costs associated with the use by these functions of facilities and equipment, such as depreciation and rental expenses.

YS BIOPHARMA CO., LTD AND SUBSIDIARIES
NOTES TO THE CONDENSED CONSOLIDATED FINANCIAL STATEMENTS
September 30, 2023 and March 31, 2023

NOTE 3 — SUMMARY OF SIGNIFICANT ACCOUNTING POLICIES (cont.)

Selling and Marketing Expenses

Selling and marketing expenses consist mainly of payroll and benefits for employees involved in the sales and distribution functions, meeting/event fees, promotion fees, marketing and selling expenses that are related to events and activities at YS Group's service centers designed to promote product sales as well as operating expenses related to the service centers.

Research and Development Expenses

R&D expenses include costs directly attributable to the conduct of R&D projects, primarily consist of salaries and other employee benefits, testing and clinical trial expenses, consulting service fees, depreciation and amortization, and office and leasing expenses. All costs associated with R&D are expensed as incurred.

Other Income (Expenses), net

Other income (expenses) consists of miscellaneous income and expenses not directly related to YS Group's core business operations. Other income primarily consists of recovery of previously written-off accounts receivable, and write-off of payment obligations that are either more than three years old or no longer justifiable. Other expenses primarily consist of late fees related to YS Group's social security insurance payment obligations, charitable donation, medical waste disposal fee and financial expenses.

From December 2013 to June 2019, because YS Group was undergoing the construction and certification process of new manufacturing plant, YS Group didn't produce and market its rabies vaccine and did not pay any income taxes nor social security insurance for its employees. It accounts for late fees as disclosed in the statements of operations.

Income Taxes

Cayman Islands. Under the current laws of the Cayman Islands, YS Group is not subject to tax on income or capital gains. In addition, upon payments of dividends by YS Group to its shareholders, no Cayman Islands withholding tax is imposed.

Hong Kong. Under the Hong Kong tax laws, Yisheng Hong Kong is exempted from profit tax on its foreign-sourced income and there are no withholding taxes in Hong Kong on remittance of dividends.

Singapore. The subsidiary incorporated in Singapore files separate income tax returns in Singapore and paid Singapore statutory income tax of 17%.

China. Pursuant to the PRC Corporate Income Tax Law and the respective regulations, subsidiaries operating in China are subject to corporate income tax at 25% on the taxable income.

United States. The subsidiary incorporated in Maryland, US is subject to statutory US federal corporate income tax at 21% and state income tax in Maryland at 8.25%.

Philippines. The subsidiary incorporated in Philippines is subject to income tax rate at 20%.

Current tax assets and liabilities are measured at the amount expected to be recovered from or paid to the taxation authorities, based on tax rates (and tax laws) that have been enacted or substantively enacted by the end of the Relevant Periods, taking into consideration interpretations and practices prevailing in the countries in which YS Group operates.

Deferred tax is provided, using the liability method in accordance with ASC740, *Income Taxes* ("ASC 740"), on all temporary differences at the end of each of the Relevant Periods between the tax bases of assets and liabilities and their carrying amounts for financial reporting purposes.

YS BIOPHARMA CO., LTD AND SUBSIDIARIES
NOTES TO THE CONDENSED CONSOLIDATED FINANCIAL STATEMENTS
September 30, 2023 and March 31, 2023

NOTE 3 — SUMMARY OF SIGNIFICANT ACCOUNTING POLICIES (cont.)

Deferred tax liabilities are recognized for all taxable temporary differences, except:

- when the deferred tax liability arises from the recognition of goodwill or an asset or liability in a transaction that is not a business combination and, at the time of the transaction, affects neither the accounting profit nor taxable profit or loss; and
- in respect of taxable temporary differences associated with investments in subsidiaries when the timing of the reversal of the temporary differences can be controlled and it is probable that the temporary differences will not reverse in the foreseeable future.

Deferred tax assets (“DTA”) are recognized for all deductible temporary differences, and the carryforward of unused tax credits and any unused tax losses. DTA are recognized to the extent it is probable that taxable profit will be available against which the deductible temporary differences, and the carryforward of unused tax credits and unused tax losses can be utilized, except:

- when the DTA relating to the deductible temporary differences arises from the initial recognition of an asset or liability in a transaction that is not a business combination and, at the time of the transaction, affects neither the accounting profit nor taxable profit or loss; and
- in respect of deductible temporary differences associated with investments in subsidiaries, DTA are only recognized to the extent that it is probable that the temporary differences will reverse in the foreseeable future and taxable profit will be available against which the temporary differences can be utilized.

The carrying amount of DTA is reviewed at the end of each reporting period and reduced to the extent it is no longer probable that sufficient taxable profit will be available to allow all or part of the DTA to be utilized.

DTA and liabilities are measured at the tax rates that are expected to apply to the period when the asset is realized or the liability is settled, based on tax rates (and tax laws) that have been enacted or substantively enacted by the end of the Relevant Periods.

DTA and liabilities are offset if and only if YS Group has a legally enforceable right to set off current tax assets and current tax liabilities and the DTA and deferred tax liabilities relate to income taxes levied by the same taxation authority on either the same taxable entity or different taxable entities which intend either to settle current tax liabilities and assets on a net basis, or to realize the assets and settle the liabilities simultaneously, in each future period in which significant amounts of deferred tax liabilities or assets are expected to be settled or recovered.

YS Group records a valuation allowance to offset DTA if based on the weight of available evidence, it is more-likely-than-not that some portion, or all, of the DTA will not be realized. The effect on deferred taxes of a change in tax rate is recognized in tax expense in the period that includes the enactment date of the change in tax rate.

YS Group accounted for uncertainties in income taxes in accordance with ASC 740. Interest and penalties arising from underpayment of income taxes shall be computed in accordance with the related PRC tax law. The amount of interest expense is computed by applying the applicable statutory rate of interest to the difference between the tax position recognized and the amount previously taken or expected to be taken in a tax return. Interest and penalties recognized in accordance with ASC 740 are classified in the consolidated statements of comprehensive loss as non-operating expense.

Value Added Tax (“VAT”)

Value-added taxes (“VAT”) collected from customers relating to product sales and remitted to governmental authorities are presented on a net basis. VAT collected from customers is excluded from revenue. The VAT payable is presented in the account of accrued expenses and other liabilities.

YS BIOPHARMA CO., LTD AND SUBSIDIARIES
NOTES TO THE CONDENSED CONSOLIDATED FINANCIAL STATEMENTS
September 30, 2023 and March 31, 2023

NOTE 3 — SUMMARY OF SIGNIFICANT ACCOUNTING POLICIES (cont.)

Taxes other than Income Tax

Under the PRC Tax Law, taxes other than income tax primarily include additional tax calculated based on value added tax payable, individual income tax, property tax, etc.

Share-based Compensation

YS Group has a share option scheme to provide incentives and rewards to eligible participants. Employees (including directors) of Company receive granted shares and share options in the form of share-based payments, whereby employees render services as consideration for equity instruments (“equity-settled transactions”).

The cost of equity-settled transactions with employees for grants is measured by reference to the FV of the equity instruments at the date when they are granted. The FV is determined by an external valuer using a binomial model. The cost of equity-settled transactions is recognized in employee benefit expense, together with a corresponding increase in equity, over the period in which the performance and/or service conditions are fulfilled.

The cumulative expense recognized for equity-settled transactions at the end of each of the relevant periods until the vesting date reflects the extent to which the vesting period has expired and YS Group’s best estimate of the number of equity instruments that will ultimately vest. The charge or credit to the statement of profit or loss for a period represents the movement in the cumulative expense recognized as at the beginning and end of that period. Service and non-market performance conditions are not taken into account when determining the grant date FV of awards, but the likelihood of the conditions being met is assessed as part of the YS Group’s best estimate of the number of equity instruments that will ultimately vest. Market performance conditions are reflected within the grant date FV. Any other conditions attached to an award, but without an associated service requirement, are considered to be non-vesting conditions. Non-vesting conditions are reflected in the FV of an award and lead to an immediate expensing of an award unless there are also service and/or performance conditions.

For awards that do not ultimately vest because non-market performance and/or service conditions have not been met, no expense is recognized. Where awards include a market or non-vesting condition, the transactions are treated as vesting irrespective of whether the market or non-vesting condition is satisfied, provided that all other performance and/or service conditions are satisfied.

Where the terms of an equity-settled award are modified, as a minimum an expense is recognized as if the terms had not been modified, if the original terms of the award are met. In addition, an expense is recognized for any modification that increases the total fair value of the share-based payments, or is otherwise beneficial to the employee as measured at the date of modification.

Where an equity-settled award is cancelled, it is treated as if it had vested on the date of cancellation, and any expense not yet recognized for the award is recognized. This includes any award where non-vesting conditions within the control of either the YS Group or the employee are not met. However, if a new award is substituted for the cancelled award, and is designated as a replacement award on the date is granted, the cancelled and new awards are treated as if they were a modification of the original award, as described in the previous paragraph. When an equity-settled award is surrendered, any expense recognized for the award is reversed immediately.

Comprehensive Loss

Comprehensive loss consists of two components, net loss and other comprehensive income (loss). Other comprehensive income (loss) consists of foreign currency translation adjustment from YS Group not using RMB as its functional currency.

YS BIOPHARMA CO., LTD AND SUBSIDIARIES
NOTES TO THE CONDENSED CONSOLIDATED FINANCIAL STATEMENTS
September 30, 2023 and March 31, 2023

NOTE 3 — SUMMARY OF SIGNIFICANT ACCOUNTING POLICIES (cont.)

Loss Per Share

In accordance with ASC 260, Earnings Per Share, basic loss per share is computed by dividing net loss attributable to ordinary shareholders by the weighted average number of ordinary shares outstanding during the period. Diluted loss per share is calculated by dividing net loss attributable to ordinary shareholders as adjusted for the effect of dilutive ordinary equivalent shares, if any, by the weighted average number of ordinary shares plus dilutive equivalent shares outstanding during the period. Dilutive equivalent shares are excluded from the computation of diluted loss per share if their effects would be anti-dilutive. No potential common shares were included in the computation of diluted loss per share when a loss from continuing operations exists.

Segment Reporting

ASC 280, “Segment Reporting”, establishes standards for reporting information about operating segments on a basis consistent with YS Group’s internal organizational structure as well as information about geographical areas, business segments and major customers in the CFS for details on YS Group’s business segments.

YS Group uses the management approach to determine reportable operating segments. The management approach considers the internal organization and reporting used by YS Group’s chief operating decision maker (“CODM”) for making decisions, allocating resources and assessing performance. YS Group’s CODM has been identified as the CEO, who reviews consolidated results when making decisions about allocating resources and assessing performance of YS Group.

Based on management’s assessment, YS Group has one operating segment, which is the development, production, marketing and sale of biopharmaceutical products. No operating segments were aggregated to form the reportable operating segment.

Significant Risks

Currency risk

A majority of YS Group’s expenses are denominated in RMB and a significant portion of YS Group and its subsidiaries’ assets and liabilities are denominated in RMB. RMB is not freely convertible into foreign currencies. In the PRC, certain foreign exchange transactions are required by law to be transacted only by authorized financial institutions at exchange rates set by the People’s Bank of China (“PBOC”). Remittances in currencies other than RMB by YS Group in China must be processed through the PBOC or other Company foreign exchange regulatory bodies which require certain supporting documentation in order to affect the remittance.

YS Group maintains bank accounts in the PRC. On May 1, 2015, China’s new Deposit Insurance Regulation came into effect, pursuant to which banking financial institutions, such as commercial banks, established in the PRC are required to purchase deposit insurance for deposits in RMB and in foreign currency placed with them. Such Deposit Insurance Regulation would not be effective in providing complete protection for YS Group’s accounts, as its aggregate deposits are higher than the compensation limit, which is RMB500,000 (approximately \$70,000) for one bank. However, YS Group believes the risk of failure of any of these Chinese banks is remote. Bank failure is uncommon in the PRC and YS Group believes that those Chinese banks that hold YS Group’s cash are financially sound based on public available information.

Concentration and political risk

Currently, YS Group involves significant operations in the PRC. Accordingly, YS Group’s business, financial condition and results of operations may be influenced by the political, economic and legal environment in the PRC, and by the general state of the PRC’s economy. YS Group’s operations in the PRC are subject to specific considerations and significant risks not typically associated with companies in North America and Western Europe. YS Group’s results may be adversely affected by changes in governmental policies in laws and regulations, anti-inflationary measures, currency conversion and remittance abroad, and rates and methods of taxation, among other things. Although YS Group has not experienced losses from these situations and believes it is in compliance with existing laws, this may not be indicative of future results.

YS BIOPHARMA CO., LTD AND SUBSIDIARIES
NOTES TO THE CONDENSED CONSOLIDATED FINANCIAL STATEMENTS
September 30, 2023 and March 31, 2023

NOTE 3 — SUMMARY OF SIGNIFICANT ACCOUNTING POLICIES (cont.)

Interest rate risk

Fluctuations in interest rates may negatively affect YS Group's financial condition and results of operations. YS Group is exposed to floating interest rate risk on cash deposit and floating rate borrowings, and the risks due to changes in interest rates is not material. YS Group has not used any derivative financial instruments to manage YS Group's interest risk exposure.

Related Parties

A party is considered related to YS Group if the party directly or indirectly or through one or more intermediaries, controls, is controlled by, or is under common control with YS Group. Related parties also include principal owners of YS Group, its management, members of the immediate families of principal owners of YS Group and its management and other parties with which YS Group may deal if one party controls or can significantly influence the management or operating policies of the other to an extent that one of the transacting parties might be prevented from fully pursuing its own separate interests. A party which can significantly influence the management or operating policies of the transacting parties or if it has an ownership interest in one of the transacting parties and can significantly influence the other to an extent that one or more of the transacting parties might be prevented from fully pursuing its own separate interests is also a related party.

Recently Issued Accounting Pronouncements

In June 2016, the FASB issued Accounting Standards Update ("ASU") 2016- 13, Financial Instruments — Credit Losses (Topic 326). The amendments in this Update require a financial asset (or a group of financial assets) measured at amortized cost basis to be presented at the net amount expected to be collected. The amendments broaden the information that an entity must consider in developing its expected credit loss estimate for assets measured either collectively or individually. The use of forecasted information incorporates more timely information in the estimate of expected credit loss, which will be more decision useful to users of the financial statements. This ASU is effective for annual and interim periods beginning after December 15, 2019 for issuers and December 15, 2020 for non-issuers. Early adoption is permitted for all entities for annual periods beginning after December 15, 2018, and interim periods therein. In May 2019, the FASB issued ASU 2019-05, Financial Instruments — Credit Losses (Topic 326): Targeted Transition Relief. This ASU adds optional transition relief for entities to elect the fair value option for certain financial assets previously measured at amortized cost basis to increase comparability of similar financial assets. The ASUs should be applied through a cumulative-effect adjustment to retained earnings as of the beginning of the first reporting period in which the guidance is effective (that is, a modified retrospective approach). On November 19, 2019, the FASB issued ASU 2019- 10 to amend the effective date for ASU 2016- 13 to be fiscal years beginning after December 15, 2022 and interim periods therein. The adoption of this ASU did not have a material impact on YS Group's CFS.

In December 2019, the FASB issued ASU 2019- 12, Income Taxes (Topic 740): Simplifying the Accounting for Income Taxes, which removes certain exceptions to the general principles in Topic 740, and improves consistent application of and simplify U.S. GAAP for other areas of Topic 740 by clarifying and amending existing guidance. For public business entities, the amendments in this update are effective for fiscal years, and interim periods within those fiscal years, beginning after December 15, 2020. For all other entities, the amendments in this update are effective for fiscal years beginning after December 15, 2021, and interim periods within fiscal years beginning after December 15, 2022. Early adoption of the amendments is permitted. The adoption of this ASU did not have a material impact on YS Group's CFS

YS Group does not believe other recently issued but not yet effective accounting standards, if currently adopted, would have a material effect on YS Group's CFS.

YS BIOPHARMA CO., LTD AND SUBSIDIARIES
NOTES TO THE CONDENSED CONSOLIDATED FINANCIAL STATEMENTS
September 30, 2023 and March 31, 2023

NOTE 4 — ACCOUNTS RECEIVABLE, NET

Accounts receivable, net are as follows:

	March 31, 2023	September 30, 2023	September 30, 2023
	(RMB)	(RMB)	(US\$)
		(Unaudited)	(Unaudited)
Trade receivables	487,418,616	459,077,454	\$ 63,940,145
Allowance for doubtful accounts	(24,366,824)	(29,708,520)	(4,137,792)
Accounts receivable, net	463,051,792	429,368,934	\$ 59,802,353

The allowance for doubtful accounts reflects YS Group's best estimate of probable losses inherent in the accounts receivable balance. YS Group estimates the allowance based on historical experience, the age of the accounts receivable balances, credit quality of YS Group's customers, current and forecasted future economic conditions, and other factors that may affect customers' ability to pay. During the six months ended September 30, 2023 and 2022, no YS Group's accounts receivable had been written off.

Below is an analysis of the movements in the allowance for doubtful accounts:

	Six Months Ended September 30,		
	2022	2023	2023
	(RMB)	(RMB)	(US\$)
Balance at beginning of the period (audited)	13,615,875	24,366,824	\$ 3,393,802
Additions (unaudited)	6,447,110	5,341,696	743,990
Balance at end of the period (unaudited)	20,062,985	29,708,520	\$ 4,137,792

NOTE 5 — INVENTORIES, NET

YS Group's inventories consist of the following:

	March 31, 2023	September 30, 2023	September 30, 2023
	(RMB)	(RMB)	(US\$)
		(Unaudited)	(Unaudited)
Raw materials	50,453,180	63,425,030	\$ 8,833,816
Work in progress	61,275,177	40,767,989	5,678,151
Finished goods ⁽¹⁾	78,432,041	118,253,022	16,470,239
Allowance for slow-moving or obsolete inventories	(4,779,446)	(9,625,670)	(1,340,660)
Inventories, net	185,380,952	212,820,371	\$ 29,641,546

(1) From March 2023, Liaoning Yisheng manufactures Yivyka Injection which obtained a pharmaceutical marketing authorization in Cambodia. All the Yivyka Injection will be exported to Cambodia and not marketed in PRC. As of September 30, 2023, approximately RMB1.0 million of Yivyka Injection was recorded in finished goods.

YS BIOPHARMA CO., LTD AND SUBSIDIARIES
NOTES TO THE CONDENSED CONSOLIDATED FINANCIAL STATEMENTS
September 30, 2023 and March 31, 2023

NOTE 5 — INVENTORIES, NET (cont.)

The movements in the allowance for slow-moving or obsolete inventories are as follows:

	Six Months Ended September 30,		
	2022	2023	2023
	(RMB)	(RMB)	(US\$)
Balance at beginning of the period (audited)	5,503,029	4,779,446	\$ 665,679
Additions (unaudited)	—	10,678,694	1,487,325
Inventories written off (unaudited)	(4,393,629)	(5,832,470)	(812,344)
Balance at end of the period	1,109,400	9,625,670	\$ 1,340,660

NOTE 6 — PROPERTY, PLANT AND EQUIPMENT, NET

Property, plant and equipment consists of the following:

	March 31, 2023	September 30, 2023	September 30, 2023
	(RMB)	(RMB)	(US\$)
		(Unaudited)	(Unaudited)
Cost			
Construction in progress	309,948,621	274,132,838	\$ 38,181,125
Plant and buildings	178,756,490	216,039,542	30,089,911
Machinery and equipment	237,637,928	241,771,870	33,673,900
Electronic equipment	11,117,440	11,314,439	1,575,871
Motor vehicles	3,031,087	3,252,678	453,032
Office equipment and furniture	34,423,995	38,522,520	5,365,403
Leasehold improvements	5,597,019	1,933,197	269,255
Total Cost	780,512,580	786,967,084	109,608,497
Less: accumulated depreciation	(178,864,241)	(195,396,698)	(27,214,783)
Less: asset impairment	(29,891,896)	(29,891,896)	(4,163,333)
Property and equipment, net	571,756,443	561,678,490	\$ 78,230,381

In fiscal 2014, based on an evaluation of the company's related production plan and conditions of property, plant and equipment, the Company recorded an asset impairment of approximately RMB29.9 million on those property, plant and equipment that could no longer be used for production.

There are no events or changes in circumstances that indicate the carrying amount of an asset may not be fully recoverable by comparing the carrying amount of the assets to the future undiscounted cash flows expected to result from the use of the assets and their eventual disposition.

YS BIOPHARMA CO., LTD AND SUBSIDIARIES
NOTES TO THE CONDENSED CONSOLIDATED FINANCIAL STATEMENTS
September 30, 2023 and March 31, 2023

NOTE 7 — PREPAID EXPENSES AND OTHER CURRENT ASSETS, NET

Prepaid expenses and other current assets, net consist of the following:

	March 31, 2023	September 30, 2023	September 30, 2023
	(RMB)	(RMB)	(US\$)
		(Unaudited)	(Unaudited)
Deposits ⁽¹⁾	4,339,791	4,204,925	\$ 585,660
Staff advances ⁽²⁾	606,859	283,299	39,458
Staff's social security ⁽³⁾	252,090	242,753	33,811
Value added tax recoverable ⁽⁴⁾	4,249,718	1,665,748	232,005
Clinical trial insurance ⁽⁵⁾	178,699	—	—
Prepaid expense ⁽⁸⁾	—	3,467,843	483,000
Other receivable ⁽⁶⁾	901,355	1,592,850	221,851
Allowance ⁽⁷⁾	(115,743)	(115,743)	(16,121)
Total	10,412,769	11,341,675	\$ 1,579,664

- (1) Deposits primarily are deposits to Centers for Disease Control and Prevention (“CDCs”) for participation in the public tender process held by province-level CDCs.
- (2) Staff advances primarily are cash advances to employees for their expected business travel or in connection with various expenses incurred in the ordinary course of business, such as sales and marketing activities.
- (3) Staff social security primarily is the portion of the government mandated defined contribution plan that should be made by employees. But this portion should be paid to the government by YS Group for the employees pursuant to PRC labor regulation. When YS Group pays wages to employees, this portion should be deducted.
- (4) Value-added taxes (“VAT”) includes input tax on purchase and output tax on sales. VAT collected from customers from product sales and remitted to governmental authorities is presented on a net basis, and it is excluded from revenue. YS Group is in a net VAT recoverable position when its input tax on purchase in the current year is greater than the output tax on sales. Such net amount can be deducted in the following years.
- (5) Clinical trial insurance is human clinical trial legal liability insurance for evaluating the safety, immunogenicity and preliminary efficacy of multiple ascending doses of PIKA recombinant protein COVID-19 Vaccine in the treatment of adult patients with mild to moderate COVID-19 infection.
- (6) Other receivable primarily consists of prepayment to third parties, such as freight, water and electricity, and promotion fees.
- (7) The allowance reflects YS Group’s best estimate of probable amounts not fully recoverable from the other receivables balance. Since some employees resigned and lost contact, the cash paid to them in advance of their expected business travel or in connection with various expense incurred in the ordinary course of business might not be recovered.
- (8) Prepaid expense primarily consists of insurance premium for directors and officers.

NOTE 8 — INTANGIBLE ASSETS, NET

YS Group’s intangible assets are presented below:

	March 31, 2023	September 30, 2023	September 30, 2023
	(RMB)	(RMB)	(US\$)
		(Unaudited)	(Unaudited)
Cost			
Patents	79,608,000	79,608,000	\$ 11,087,774
Licenses, software and laboratory information system	10,435,478	10,435,478	1,453,450
Land use rights	67,181,860	67,181,860	9,357,066
Total Cost	157,225,338	157,225,338	21,898,290
Less: Accumulated Amortization	(79,168,546)	(82,586,982)	(11,502,686)
Intangible Assets, net	78,056,792	74,638,356	\$ 10,395,604

YS BIOPHARMA CO., LTD AND SUBSIDIARIES
NOTES TO THE CONDENSED CONSOLIDATED FINANCIAL STATEMENTS
September 30, 2023 and March 31, 2023

NOTE 9 — BANK LOANS AND OTHER BORROWINGS

Bank loans and other borrowings are as follows:

	March 31, 2023	September 30, 2023	September 30, 2023	Maturity Date	Interest Rate
	(RMB)	(RMB)	(US\$)		
		(Unaudited)	(Unaudited)		
China Guangfa Bank Co., Ltd. – Shenyang Branch ⁽¹⁾	41,191,031	45,351,601	\$ 6,316,555	2023/12/16 – 2024/3/12	5.66%
Shanghai Pudong Development Bank Co., Ltd. Shenyang Branch ⁽²⁾	82,964,518	—	—	2023/6/29 – 2023/12/12	5.30%
China CITIC Bank Shenyang Tiexi Branch ⁽⁴⁾	23,596,350	36,424,414	5,073,179	2023/10/13 – 2024/5/29	5.00%
China CITIC Bank Shenyang Tiexi Branch ⁽⁵⁾	5,000,000	—	—	2023/5/25 – 2023/7/17	3.25%
China CITIC Bank Shenyang Tiexi Branch ⁽⁶⁾	—	3,550,600	494,526	2024/5/29	4.75%
China Construction Bank Shenyang Heping Branch ⁽⁷⁾	31,330,000	33,160,000	4,618,513	2023/11/21 – 2024/8/31	4.00%
China Construction Bank Shenyang Heping Branch ⁽⁸⁾	988,000	1,700,400	236,831	2024/1/12 – 2024/7/19	3.90%
Zhongguancun Technology Leasing Co., Ltd ⁽¹⁰⁾	8,666,664	8,666,664	1,207,090	2025/11/7	5.00%
CITIC Financial Leasing Co., Ltd ⁽¹¹⁾	—	12,825,276	1,786,300	2026/5/29	4.80%
Minsheng Bank Shenyang Huanghe Street Branch ⁽¹²⁾	—	11,286,310	1,571,953	2024/7/7 – 2024/7/19	4.00%
Industrial Bank Shenyang Branch ⁽¹⁴⁾	—	29,776,670	4,147,285	2024/8/15 – 2024/9/17	4.00%
Bank loans due within one year	193,736,563	182,741,935	25,452,232		
R-Bridge Healthcare Fund, LP ⁽³⁾	274,868,000	287,192,000	40,000,000	2026/9/15	4.00%
China Construction Bank Shenyang Heping Branch ⁽⁹⁾	4,430,000	14,720,000	2,050,196	2024/9/16 – 2024/12/6	4.00%
Zhongguancun Technology Leasing Co., Ltd ⁽¹⁰⁾	14,492,596	10,111,116	1,408,273	2025/11/7	5.00%
CITIC Financial Leasing Co., Ltd ⁽¹¹⁾	—	23,993,182	3,341,762	2026/5/29	4.80%
Industrial Bank Shenyang Branch ⁽¹³⁾	—	19,993,041	2,784,624	2026/7/31 – 2026/9/3	4.25%
Shanghai Pudong Development Bank Co., Ltd. Shenyang Branch ⁽¹⁵⁾	—	5,955,734	829,512	2024/3/21 – 2025/9/26	4.00%
Long-term bank loans	293,790,596	361,965,073	50,414,367		
Total bank loans	487,527,159	544,707,008	\$ 75,866,599		

- (1) On September 13, 2021, YS Group entered into a credit facility of RMB100 million with China Guangfa Bank Co., Ltd. Shenyang Branch for three years to finance our working capital requirements. YS Group drew RMB45.4 million from January 13, 2023 to August 24, 2023. As of date of this report, YS Group repaid RMB45.4 million.
- (2) On July 12, 2021, YS Group entered into a credit facility of RMB140 million with Shanghai Pudong Development Bank Co., Ltd. Shenyang Branch for three years to finance its working capital requirements. YS Group drew RMB83.0 million from June 30, 2022 to December 13, 2022. In April, July and September, 2023, YS Group repaid RMB20.9 million, RMB32.4 million and RMB29.7 million, respectively.

YS BIOPHARMA CO., LTD AND SUBSIDIARIES
NOTES TO THE CONDENSED CONSOLIDATED FINANCIAL STATEMENTS
September 30, 2023 and March 31, 2023

NOTE 9 — BANK LOANS AND OTHER BORROWINGS (cont.)

- (3) On March 16, 2022, YS Group entered into a facility agreement with R-Bridge Healthcare Fund, LP, as agent, to finance RMB287,192,000 (US\$40,000,000) for 54 months. YS Group shall repay the loan in instalments by repaying on each Repayment Date which means the fifth business day after each financial quarter date an amount equal to the relevant percentage of the aggregate outstanding principal amount of the loan as at the end of the Availability Period as set out in the table below:

Repayment Date	Repayment Instalment
April 7, 2025	6,400,000
July 7, 2025	6,400,000
October 7, 2025	6,400,000
January 7, 2026	6,400,000
April 7, 2026	6,400,000
July 7, 2026	8,000,000
Total	40,000,000

Under the terms of the Facility Agreement, YS Group shall ensure:

- (a) at any time on or prior to the date falling 12 months after the utilization date:
- (i) the net sales of the included products in respect of each period of 12 months ending on the last day of each financial year and each period of 12 months ending on the last day of each financial quarter (“Relevant Period”) shall not be less than RMB400,000,000; and
 - (ii) the total debt to net sales of the included products for any Relevant Period shall not be more than 1.25:1;
- (b) at any time after the date falling 12 months after the utilization date:
- (i) the net sales of the included products in respect of any annual Relevant Period shall not be less than RMB500,000,000; and
 - (ii) the total debt to net sales of the included products for any Relevant Period shall not be more than 1:1;
- (c) the EBITDA margin for any Relevant Period shall not be less than 25%; and
- (d) at any time after the date falling 18 Months after the utilization date, the EBITDA margin for any Relevant Period shall not be less than 20%.

If there is (or it is anticipated that there will be) a breach, YS Group may apply for a waiver of such breach or requirement by the majority lenders. Such breach shall cease to constitute an event of default if the majority lenders agreed to grant such waiver. If not, YS Group shall prepay the loan in whole or in part.

YS Group shall ensure that no other group member will acquire any company, shares, securities, business, assets, or undertaking or make any investment except for that an acquisition the total consideration for which (when aggregated with (A) the total consideration for any other acquisition made in the same financial year, and (B) the aggregate amount of investments in any joint venture made in the same financial year) does not exceed RMB30,000,000 (or its equivalent in another currency or currencies). On December 27, 2023, YS Group received a letter from R-Bridge (the “R-Bridge Letter”), notifying YS Group they have reason to believe YS Group has defaulted under financial covenants and other obligations under the facility agreement, and under the instructions of the lenders to urge YS Group to consider and reach an amicable solution with the lenders, including, without limitation, repaying the Loan in full, as soon as possible. In response to the R-Bridge Letter, YS Group has provided the financial information to R-Bridge at its request and is currently working with the lenders under the facility agreement to negotiate a resolution. If lenders under the facility agreement are not satisfied and insist YS Group has defaulted under the facility agreement, such lenders may declare all or part of the loan, the accrued interest, and all other amounts accrued or outstanding be immediately due and payable. If such lenders demand the prepayment of the loan in its full amount of \$40 million, YS Group may be forced to seek additional funding to meet its obligation under the facility agreement, otherwise it may not be able to continue as a going concern.

Under the terms of the Facility Agreement, YS Group and Agent also entered into a Deed, pursuant to which YS Group will pay to Agent, the Royalties on the Products as contingent interest in addition to the payments made to Agent under the Facility Agreement, on the terms and subject to the conditions of the Deed. YS Group is obliged to pay royalties to such agent as contingent interest for the facility based upon YS Group’s annual net sales of rabies vaccines by multiplying the royalty rate ranging from 1.5% to 3.5% by the corresponding amount incremental net sales for that financial year.

YS Group shall pay accrued interest on the Loan on each Payment Date. As of September 30, 2023, YS Group accrued approximately RMB4.4 million (US\$0.6 million) of interest.

- (4) On January 13, 2023, YS Group entered into a credit facility of RMB40 million with China CITIC Bank Shenyang Tiexi Branch, due on November 29, 2023, to finance our working capital requirements. YS Group drew RMB36.4 million from January 18, 2023 to July 11, 2023. As of date of this report, YS Group repaid RMB23.6 million.

YS BIOPHARMA CO., LTD AND SUBSIDIARIES
NOTES TO THE CONDENSED CONSOLIDATED FINANCIAL STATEMENTS
September 30, 2023 and March 31, 2023

NOTE 9 — BANK LOANS AND OTHER BORROWINGS (cont.)

- (5) On May 6, 2022, China CITIC Bank Shenyang Tiexi Branch issued one letter of credit of RMB5.0 million to YS Group. As of March 31, 2023, YS Group had RMB4.7 million in letters of credit issued, which is due from May to July 2023, YS Group repaid RMB4.7 million.
- (6) From July 17 to July 18, 2023, YS Group borrowed RMB3,550,600 from China CITIC Bank Shenyang Tiexi Branch.
- (7) From November 22, 2022 to September 1, 2023, YS Group borrowed RMB33.2 million in total from China Construction Bank Shenyang Heping Branch for one year. As of date of this report, YS Group repaid RMB8.9 million.
- (8) On January 16, 2023, YS Group borrowed RMB988,000 from China Construction Bank Shenyang Heping Branch for one year. In December 2023, YS Group repaid RMB988,000 in advance. On July 20, 2023, YS Group borrowed RMB712,400 with interest at 3.90% for one year. The loan is due on July 19, 2024.
- (9) From March 17 to June 7 2023, YS Group borrowed RMB14.7 million from China Construction Bank Shenyang Heping Branch for 18 months.
- (10) On November 8, 2022, YS Group borrowed RMB26.0 million from Zhongguancun Technology Leasing Co., Ltd for 36 months. YS Group shall repay RMB722,222 monthly from December 15, 2022 to October 15, 2025 and pay the last repayment of RMB722,230 on November 7, 2025. YS Group repaid RMB7.2 million from December 2022 to September 2023. The balance of RMB18.8 million is outstanding, of which RMB8.7 million is due within one year. As of date of this report, YS Group repaid RMB2.9 million.
- (11) On May 29, 2023, YS Group borrowed RMB40.0 million from CITIC Financial Leasing Co., Ltd. On August 15, 2023, we repaid RMB3.2 million. The balance of RMB36.8 million is outstanding, of which RMB12.8 million is due within one year. As of date of this report, YS Group repaid RMB3.2 million.
- (12) From July 7 to July 19, 2023, YS Group borrowed RMB11.3 million from Minsheng Bank Shenyang Huanghe Street Branch for one year.
- (13) On August 14 and September 14, 2023, YS Group borrowed RMB4.0 million and RMB16.0 million from Industrial Bank Shenyang Branch for approximately three years.
- (14) From August 16 to September 18, 2023, YS Group borrowed RMB29.8 million from Industrial Bank Shenyang Branch for one year.
- (15) On September 27, 2023, YS Group borrowed RMB6.0 million from Shanghai Pudong Development Bank Co., Ltd. Shenyang Branch.

YS Group recorded RMB14.9 million and RMB15.2 million of interest expense for the six months ended September 30 2023 and 2022, respectively.

NOTE 10 — LEASES

A summary of YS Group's operating leases as of March 31, 2023 and September 30, 2023 are as follows:

	March 31, 2023	September 30, 2023	September 30, 2023
	(RMB)	(RMB)	(US\$)
		(Unaudited)	(Unaudited)
Operating lease ROU assets	11,132,428	9,607,109	\$ 1,338,075
Operating lease liabilities – current	4,753,547	5,027,649	\$ 700,249
Operating lease liabilities – non-current	6,348,890	4,462,505	\$ 621,536
Weighted average remaining lease term	2.5	2.0	2.0
Weighted average discount rate	4.7%	4.9%	4.9%

A summary of lease cost recognized in YS Group's CFS and supplemental cash flow information for operating leases is as follows:

	Six Months Ended September 30,		
	2022	2023	2023
	(RMB)	(RMB)	(US\$)
	(Unaudited)	(Unaudited)	(Unaudited)
Operating lease cost	2,508,388	2,711,527	\$ 377,661
Cash paid for operating leases	786,888	2,822,023	\$ 393,050

YS BIOPHARMA CO., LTD AND SUBSIDIARIES
NOTES TO THE CONDENSED CONSOLIDATED FINANCIAL STATEMENTS
September 30, 2023 and March 31, 2023

NOTE 10 — LEASES (cont.)

A summary of maturity of operating lease liabilities under the YS Group's non-cancelable operating leases as of September 30, 2023 is as follows:

12 months Ending September 30,	As of September 30, 2023	
	(RMB)	(US\$)
2024	5,332,992	\$ 742,777
2025	4,275,341	595,468
2026	357,806	49,835
Total lease payments	9,966,139	1,388,080
Less: Interest	(475,985)	(66,295)
Present value of operating lease liabilities	9,490,154	\$ 1,321,785

NOTE 11 — ACCRUED EXPENSES AND OTHER CURRENT LIABILITIES

Accrued expenses and other current liabilities consist of the following:

	March 31, 2023	September 30, 2023	September 30, 2023
	(RMB)	(RMB)	(US\$)
		(Unaudited)	(Unaudited)
Salaries and social security insurance payable ⁽¹⁾	55,188,497	55,003,111	\$ 7,660,814
Promotion service fee ⁽²⁾	87,567,459	110,977,249	15,456,872
Taxes other than income tax	379,595	—	—
Late fees ⁽³⁾	9,927,056	10,219,206	1,423,327
Payable for property, plant and equipment	47,579,463	30,549,960	4,254,988
CDC transportation and storage fee	49,976,200	45,314,910	6,311,445
Guarantee deposits ⁽⁴⁾	108,795,884	121,848,973	16,971,082
Professional service fees ⁽⁵⁾	5,121,970	2,290,725	319,051
Interest payable ⁽⁶⁾	6,055,245	4,652,964	648,063
Other ⁽⁷⁾	6,945,275	7,214,894	1,004,888
Total	377,536,644	388,071,992	\$ 54,050,530

(1) This includes unpaid salaries and outstanding social security insurance. Salaries and social security insurance payables consist of the following:

	March 31, 2023	September 30, 2023	September 30, 2023
	(RMB)	(RMB)	(US\$)
		(Unaudited)	(Unaudited)
Salaries	47,390,831	47,586,649	\$ 6,627,852
Social security insurance	7,179,828	6,808,494	948,285
Union Fee	617,838	607,968	84,677
Total	55,188,497	55,003,111	\$ 7,660,814

(2) Promotion service fee primarily is for the vaccine promotion, including design and implementation of academic activities, and collection of market information.

(3) Late fees primarily are fees for corporate income tax, taxes other than income tax and social security insurance and housing reserve fund contributions due to the fact that YS Group failed to pay income tax for calendar 2011 to calendar 2013, taxes other than income tax for calendar 2014 to the beginning of calendar 2021 and social security insurance for calendar 2015 to the beginning of calendar 2021. As of June, 2021, YS Group paid the unpaid taxes, including income tax and other taxes other than income tax, as well as the late fees charge of them. From fiscal 2022, the late fee is incurred for unpaid social insurance.

YS BIOPHARMA CO., LTD AND SUBSIDIARIES
NOTES TO THE CONDENSED CONSOLIDATED FINANCIAL STATEMENTS
September 30, 2023 and March 31, 2023

NOTE 11 — ACCRUED EXPENSES AND OTHER CURRENT LIABILITIES (cont.)

- (4) Guarantee deposits primarily are refundable deposits paid to YS Group by external service providers to guarantee us that external service providers will provide us with high quality and reasonable professional services. The external service providers' professional service scope includes conducting market research and analysis, monitoring product clinical information, collecting and reporting adverse events of the product use, providing academic visits and education seminars, assisting product shipment and payment collections. Their services don't assume inventory risk for the vaccines before they are transferred to the end customers.
- (5) Professional service fees primarily are from consultants and other advisors.
- (6) Interest payable primarily is interest and royalties payable to R-Bridge Healthcare Fund, LP.
- (7) Other primarily is employees' reimbursement and value added tax.

NOTE 12 — WARRANTS

As of September 30, 2023, YS Group has 10,750,000 public warrants and 6,000,000 private warrants.

YS Group accounts for its outstanding warrants in accordance with ASC 815-40-15-7D and 7F. Management determined the private warrants do not meet the criteria for equity treatment and must be recorded as liabilities. Accordingly, YS Group records the private warrants as liabilities at their FV and adjusts them to FV at each reporting period. Management further determined its public warrants qualify for equity treatment. Warrant liability is subject to re-measurement at each balance sheet date until exercised, and any change in FV is recognized in statements of operations. The private warrants are valued using a Binomial Option Pricing Model.

Upon the consummation of the business combination, each Summit Warrant outstanding ceased to be a warrant with respect to Summit Public Shares and be assumed by YS Biopharma and converted into a YS Biopharma Warrant entitling the holder thereof to purchase such number of Ordinary Share on a one-on-one basis. Each YS Biopharma Warrant will otherwise continue to have and be subject to substantially the same terms and conditions as were applicable to such Summit Warrant immediately prior to the consummation of the Business Combination (including any repurchase rights and cashless exercise provisions). Upon the consummation of the Business Combination with Summit, YS Group had 10,000,000 public and 6,000,000 private warrants.

The private warrants are accounted for as liabilities in accordance with ASC 815-40 and are presented within warrant liabilities on the balance sheets. The warrants were classified as Level 3 at the initial measurement date due to the use of unobservable inputs. The Binomial Option Pricing Model with the following key assumptions is used for estimating the FV of private warrants.

	As of September 30, 2023
Fair value of the underlying asset as of the Valuation Date	0.8
Strike price	11.5
Life to expiration (Years.)	4.5
Volatility	67.0%
Number of steps	100
Redemption price (per share)	0.1

As of September 30, 2023, the value of the private warrants was RMB2.2 million. The change in FV from March 31, 2023 to September 30, 2023 was RMB6.9 million. The table below reflects the movement of warrant liabilities for the six months ended September 30, 2023:

	April 1, 2023	Additions	Change in fair value	Foreign currency translation	September 30, 2023	September 30, 2023
	(RMB)	(RMB)	(RMB)	(RMB)	(RMB)	(US\$)
Private Warrants	8,792,389	—	(6,851,308)	244,041	2,185,122	\$ 304,343
Total	8,792,389	—	(6,851,308)	244,041	2,185,122	\$ 304,343

YS BIOPHARMA CO., LTD AND SUBSIDIARIES
NOTES TO THE CONDENSED CONSOLIDATED FINANCIAL STATEMENTS
September 30, 2023 and March 31, 2023

NOTE 13 — WARRANTS ACCOUNTED AS EQUITY-METHOD INSTRUMENTS

Upon consummation of the Business Combination with Summit, Summit's 10,000,000 public warrants were converted into YS Biopharma warrants, and YS Group sold additional 750,000 public warrants.

Following the Business Combination, YS Biopharma may redeem public warrants prior to their exercise at a time that is disadvantageous to the holders of such warrants, thereby making such warrants worthless. More specifically:

- YS Biopharma can redeem outstanding warrants at any time after they become exercisable and prior to their expiration, at \$0.01 per warrant, provided the last reported sales price of YS Biopharma Ordinary Shares equals or exceeds \$18.00 per share (as adjusted for capitalization, share dividends, split-up and the like) for any 20 trading days within a 30 trading-day period ending on the third trading day prior to proper notice of such redemption and provided that certain other conditions are met.
- YS Biopharma also can redeem outstanding warrants at any time after they become exercisable and prior to their expiration, at \$0.10 per warrant upon a minimum of 30 days' prior written notice of redemption provided that the last reported sales price of YS Biopharma Ordinary Shares equals or exceeds \$10.00 per share (as adjusted for capitalization, share dividends, split-up and the like) for any 20 trading days within a 30 trading-day period ending on the third trading day prior to proper notice of such redemption and provided that certain other conditions are met, including that holders of the Warrants will be able to exercise their Warrants prior to redemption for a number of YS Biopharma Ordinary Shares determined based on the redemption date and the fair market value of the YS Biopharma Ordinary Shares. The value received upon exercise of the Warrants: (1) may be less than the value the holders would have received if they had exercised their Warrants at a later time where the underlying share price is higher and (2) may not compensate the holders for the value of the warrants, including because the number of YS Biopharma Ordinary Shares received is capped at 0.361 YS Biopharma Ordinary Shares per warrant (subject to adjustment) irrespective of the remaining life of the warrants

In each case, YS Biopharma may only call the Warrants for redemption upon a minimum of 30 days' prior notice of redemption.

Redemption of the outstanding Warrants could force holders of the Warrants to (a) exercise Warrants and pay the exercise price therefor at a time when it may be disadvantageous for such holders to do so, (b) sell Warrants at the then-current market price when they might otherwise wish to hold their Warrants or (c) accept the nominal redemption price which, at the time the outstanding Warrants are called for redemption, is likely to be substantially less than the market value of the Warrants.

NOTE 14 — STOCK-BASED COMPENSATION

YS Group operates a share-based payment scheme (the "Scheme") to provide incentives and rewards to eligible participants who contribute to the success of YS Group's operations. Eligible participants of the Scheme include YS Group's directors, employees and consultants.

The 2010 Share Incentive Plan

On June 21, 2010, YS Group adopted the 2010 Share Incentive Plan (the "Plan") that has a contractual term of 10 years. The Plan provides for the granting of stock options and other stock-based awards to employees and directors. YS Group's Board of Directors authorized and reserved the issuance of up to 2,725,650 ordinary shares under the Plan from 2010 to 2013, giving retroactive effect of combination in March 2023. Starting from 1 January 2014, the maximum number of shares subject to awards that may be granted during any single calendar year is 1.5% of total issued and outstanding shares as of the first business day of that calendar year.

The stock options granted to employees are accounted for as equity awards and measured at their grant date FVs. Options that vest based on service conditions generally become vested over a three-year period in equal quarterly instalments of 0.08% each on the last day of every quarter that has elapsed until the options are 100% vested.

YS BIOPHARMA CO., LTD AND SUBSIDIARIES
NOTES TO THE CONDENSED CONSOLIDATED FINANCIAL STATEMENTS
September 30, 2023 and March 31, 2023

NOTE 14 — STOCK-BASED COMPENSATION (cont.)

On January 1, 2015, an annual grant of 127,500 options, giving retroactive effect of combination in March 2023, which vest based on performance conditions, were granted to various employees. The annual grant was applicable for calendar 2015, 2016, 2017, 2018, 2019 and 2020, respectively. The options vest in equal quarterly instalments based on performance targets established on January 1st of each calendar year from 2015 to 2020. There are no more grants after December 31, 2020 under the 2010 share incentive plan.

For options granted to YS Group’s senior executives, the grantee can exercise vested options after the commencement date of exercise and before the earlier of: 1) its contractual term (i.e., 10 years after each of its vesting date); or 2) 5 years after the grantee terminates their employment if the vested option has not been exercised.

For options granted to the remaining employees, the grantee can exercise vested options after the commencement date of exercise and before the earlier of: 1) its contractual term (i.e., 10 years after each of its vesting date); or 2) 12 months after the grantee terminates their employment if the vested option has not been exercised.

For those awards, evaluations are made as of each reporting period to assess the likelihood of performance criteria being met. Share-based payment expenses are then adjusted to reflect the revision of original estimates.

The exercise prices and exercise periods, giving retroactive effect of combination in March 2023, of the share options outstanding as at the end of each of the Relevant Periods are as follows:

	Number of shares options	Average exercise price per share option
		(RMB)
As of March 31, 2022	3,253,565	29.3156
Granted during the period	—	—
Forfeited during the period	—	—
Exercised during the period	—	—
Expired during the period	—	—
As of March 31, 2023	3,253,565	32.4020
Granted during the period	—	—
Forfeited during the period	—	—
Exercised during the period	—	—
Expired during the period	—	—
As of September 30, 2023	3,253,565	32.4020

The exercise prices and exercise periods of the share options outstanding as at the end of the reporting periods are as follows:

Six Months Ended September 30, 2023			
Number of options	Exercise price	Exercise period	
	(RMB)		
1,533,252	13.938	2021 – 2031	
613,369	25.8524	2021 – 2026	
1,106,944	52.5376	2021 – 2026	
3,253,565			

Restricted share units (“RSU”)

Giving retroactive effect of combination in March 2023, on February 1, 2018, YS Group granted 692,500 RSUs to employees under the Plan. The weighted average grant-date FV of restricted share units was \$7.24, which was derived from the FV of the underlying ordinary shares. 405,000 of the 692,500 restricted share units were subject to service conditions vesting in six equal semi-annual instalments over three years or eight equal semi-annual instalments over

YS BIOPHARMA CO., LTD AND SUBSIDIARIES
NOTES TO THE CONDENSED CONSOLIDATED FINANCIAL STATEMENTS
September 30, 2023 and March 31, 2023

NOTE 14 — STOCK-BASED COMPENSATION (cont.)

four years, respectively. The remaining 287,500 RSUs vested on March 16, 2023 due to the successful closing of the public offering. YS Group recognized expenses associated with these RSUs immediately in fiscal 2023. As of March 31, 2023, all the granted options are vested, and there were no unrecognized share-based payment expenses related to unvested restricted shares.

Giving retroactive effect of combination in March 2023, on July 25, 2018, YS Group granted 270,000 RSUs to three independent directors. Starting from the effective date of August 1, 2018, 30,000 RSUs will be awarded to each of the three directors annually, which shall vest at 7,500 units per three months' Director services rendered by each director. For each of the new directors, 5,000 units will be vested for the two-month period starting from August 1, 2018, and the remaining vested quarterly from October 1, 2018 to July 31, 2021. The grant-date FV of the restricted share units was \$1.84, which was derived from the FV of the underlying ordinary shares. As of March 31, 2023, all the granted options are vested and there were no unrecognized share-based payment expenses related to unvested restricted shares.

The 2020 Share Incentive Plan

On December 31, 2020, YS Group's board of directors adopted the 2020 Share Incentive Plan to grant share-based compensation awards to employees, directors and consultants to incentivize their performance and align their interests with YS Group. Pursuant to such plan, YS Group can grant awards to directors, employees and consultants of YS Group with rights to subscribe for up to 8,750,000 underlying ordinary shares of YS Biopharma. As of the date of this report, (1) 2,093,418 shares as RSU incentive shares were fully vested and issued to the respective directors and employees of YS Group, and (2) 6,656,582 shares are reserved but not issued, among which, options to subscribe for 3,471,546 ordinary shares of YS Biopharma are granted to certain senior management and employees of YS Group but not exercised, giving retroactive effect of combination in March 2023.

Stock-based compensation expense included in YS Group's consolidated statements of operations and comprehensive loss is as follows:

	Six Months Ended September 30,		
	2022	2023	2023
	(RMB)	(RMB)	(US\$)
	(Unaudited)	(Unaudited)	(Unaudited)
Research and development	(1,015,055)	—	\$ —
General and administrative	929,739	—	—
Total stock-based compensation	(85,316)	—	\$ —

On August 15, 2022, unanimous written resolution of the BOD of YS Group accepted from a former employee, surrender of 143,750 of issued shares with US\$0.00002 each in YS Group registered in his name, giving retroactive effect of combination in March 2023.

NOTE 15 — RELATED PARTY TRANSACTIONS AND BALANCES

The following companies are related parties that had balances or transactions with YS Group as of and during the six months ended September 30, 2023 and 2022:

Name of related parties	Relationship with YS Group
Yisheng Biopharma Co., Ltd	An entity controlled by Yi Zhang
Yisheng Biopharma Holdings Ltd.	An entity controlled by Yi Zhang
Kaifeng Yisheng Pan-Asia Technology Co., Ltd	An entity controlled by Yi Zhang
Beijing Yisheng Xingye Technology Co., Ltd.	An entity controlled by Yi Zhang
Changchun Bailong Biotechnology Co., Ltd.	An entity controlled by Yi Zhang
Henan Yisheng Huizhong Health Services Co., Ltd.	An entity controlled by Yi Zhang
Henan Yisheng Biopharma Co., Ltd.	An entity controlled by Yi Zhang
Beijing Huaerdun Kangqi Biotechnology Co., Ltd.	An entity controlled by Yi Zhang

YS BIOPHARMA CO., LTD AND SUBSIDIARIES
NOTES TO THE CONDENSED CONSOLIDATED FINANCIAL STATEMENTS
September 30, 2023 and March 31, 2023

NOTE 15 — RELATED PARTY TRANSACTIONS AND BALANCES (cont.)

Name of related parties	Relationship with YS Group
Liaoning Yisheng Pan-Asia	An entity controlled by Yi Zhang
Yi Zhang*	Chairman of Board of Directors
Hui Shao	Chief Executive Officer
Nan Zhang	Daughter of the Chairman
Xu Zhang	Daughter of the Chairman
Rui Mi	Spouse of the Chairman

* On December 9, 2023, the Board, acting upon an ad hoc motion raised at a Board meeting, appointed Dr. Ajit Shetty, an independent director of YS Group, as an interim Chairperson of the Board for a six-month period to replace Mr. Yi Zhang, the current Chairperson of the Board, effective from December 9, 2023. Mr. Yi Zhang remains as a director of the Board.

Transactions with related parties

There's no transaction with related parties during the six months ended September 30, 2022. In July, 2023, YS Group spent US\$20,000 to purchase a vehicle from Ms. Ruimi, spouse of Mr. Yi Zhang.

NOTE 16 — INCOME TAX

Cayman Islands. Under the current laws of the Cayman Islands, YS Group is not subject to tax on income or capital gains. In addition, upon payments of dividends by YS Group to its shareholders, no Cayman Islands withholding tax is imposed.

Hong Kong. Under the Hong Kong tax laws, Yisheng Hong Kong, as a holding company, is exempted from profit tax on its foreign-sourced income and there are no withholding taxes in Hong Kong on remittance of dividends.

Singapore. Yisheng Singapore, a subsidiary incorporated in Singapore, files separate income tax returns in Singapore at the statutory income tax rate of 17%.

China. Under the Enterprise Income Tax ("EIT") Law of the PRC, domestic enterprises and Foreign Investment Enterprises (the "FIE") are usually subject to a unified 25% EIT rate while preferential tax rates, tax holidays, and even tax exemption may be granted on case-by-case basis. The PRC tax authorities grant preferential tax treatment to High and New Technology Enterprises ("HNTEs"). Under this preferential tax treatment, HNTEs are entitled to an income tax rate of 15%, subject to a requirement that they re-apply for HNTE status every three years. Since Liaoning Yisheng and Beijing Yisheng were approved as an HNTE in December 2021 and December 2022, Liaoning Yisheng and Beijing Yisheng are entitled to a reduced income tax rate of 15% and is able to enjoy the reduced income tax rate in the next three years.

United States. US Yisheng, a subsidiary incorporated in Maryland, United States is subject to statutory federal corporate income tax at 21% and state income tax at 8.25%.

Philippines. The subsidiary incorporated in Philippines is subject to income tax at 20%.

The provision for income tax consisted only of deferred tax.

The following table reconciles the statutory rate to YS Group's effective tax rate:

	Six Months Ended September 30,	
	2022	2023
	(Unaudited)	(Unaudited)
PRC statutory income tax rate	25.00%	25%
Effect of different tax rates in different jurisdictions	(182.62)%	(14.93)%
Effect of PRC preferential tax rate	(100.49)%	3.93%
Effect of R&D expenses deduction and other	80.56%	11.94%
Temporary differences*	5.03%	(0.71)%
Change in valuation allowance	177.88%	(25.70)%
Effective tax rate	5.36%	(0.47)%

* Temporary differences primarily are for impairment of inventories, property, plant and equipment and government grants.

YS BIOPHARMA CO., LTD AND SUBSIDIARIES
NOTES TO THE CONDENSED CONSOLIDATED FINANCIAL STATEMENTS
September 30, 2023 and March 31, 2023

NOTE 16 — INCOME TAX (cont.)

Net deferred tax assets as of September 30, 2023 and March 31, 2023, consist of the following:

	March 31, 2023	September 30, 2023	September 30, 2023
	(RMB)	(RMB)	(US\$)
		(Unaudited)	(Unaudited)
Deferred tax assets:			
Write-down of inventories to net realizable value	716,917	1,443,851	\$ 201,099
Impairment of property, plant and building	1,769,405	1,638,378	228,193
Deferred government grants	3,296,223	3,124,045	435,116
Losses available for offsetting against future taxable profits	39,366,020	39,366,020	10,792,055
Less: valuation allowance	(39,366,020)	(39,366,020)	(10,792,055)
Total deferred tax assets, net	5,782,545	6,206,274	864,408
Deferred tax liabilities:			
Fair value adjustments arising from historical acquisition of subsidiaries	(3,876,964)	(3,480,340)	(484,741)
Total deferred tax liabilities	(3,876,964)	(3,480,340)	(484,741)
Net deferred tax asset	1,905,581	2,725,934	\$ 379,667

In assessing the realizability of the net DTA, YS Group considers all relevant positive and negative evidence in determining whether it is more likely than not that some portion or all of the deferred income tax assets will not be realized. The realization of the gross DTA is dependent on several factors, including the generation of sufficient taxable income in the future. Based upon an assessment of the level of historical taxable income and projections for future taxable income over the periods in which the DTA are deductible or can be utilized. The amount of the DTA is considered unrealizable because it is more likely than not that YS Group will not generate sufficient future taxable income to utilize this portion of the net operating loss.

Uncertain tax positions

There were no uncertain tax positions as of September 30, 2023 and March 31, 2023 and management does not anticipate any potential future adjustments which would result in a material change to its tax positions.

NOTE 17 — DEFERRED GOVERNMENT GRANTS

Deferred government grants are funds received from the PRC government for R&D, investment in building or improvement in YS Group's production facilities. These specific subsidies are recorded as deferred government grants upon receipt and are recognized as government grants recognized in income when the conditions are met. Other subsidies are recognized as other income upon receipt as further performance by YS Group is not required. YS Group received government grants that were deferred of nil and RMB1.2 million in the six months of 2023 and 2022, respectively. In addition, YS Group received RMB13.5 million and RMB13.2 million other subsidies that the government has not set any conditions and are not tied to future trends or performance of YS Group and were recognized in other income in the six months of 2023 and 2022, respectively.

YS BIOPHARMA CO., LTD AND SUBSIDIARIES
NOTES TO THE CONDENSED CONSOLIDATED FINANCIAL STATEMENTS
September 30, 2023 and March 31, 2023

NOTE 17 — DEFERRED GOVERNMENT GRANTS (cont.)

Deferred government grants included the following:

	March 31, 2023	September 30, 2023	September 30, 2023
	(RMB)	(RMB)	(US\$)
		(Unaudited)	(Unaudited)
Government grants for property, plant and equipment			
Balance at beginning of the period (audited)	22,030,690	20,575,012	\$ 2,865,680
Addition	—	—	—
Recognized as income	(1,455,678)	(727,839)	(101,373)
Subtotal	20,575,012	19,847,173	\$ 2,764,307
Government grants for R&D			
Balance at beginning of the period (audited)	10,318,528	5,327,196	\$ 741,970
Addition	4,000,000	—	—
Recognized as income	(8,991,332)	(420,011)	(58,499)
Subtotal	5,327,196	4,907,185	\$ 683,471
Total deferred government grants	25,902,208	24,754,358	\$ 3,447,778
Less: current portion	2,295,701	2,295,701	\$ 319,744
Non-current portion	23,606,507	22,458,657	\$ 3,128,034

Government grants included the following:

	September 30,		
	2022	2023	2023
	(RMB)	(RMB)	(US\$)
		(Unaudited)	(Unaudited)
Government grants for property, plant and equipment			
Specific subsidies	727,839	727,839	\$ 101,373
Other subsidies	—	260,200	36,241
Subtotal	727,839	988,039	\$ 137,614
Government grants for R&D			
Specific subsidies	8,498,711	420,011	\$ 58,499
Other subsidies	—	2,510,000	349,592
Subtotal	8,498,711	2,930,011	\$ 408,091
Other	13,230,141	10,709,509	\$ 1,491,616
Total	22,456,691	14,627,559	\$ 2,037,321

Government grants for property, plant and equipment

YS Group has seven deferred government grants for property, plant and equipment, and fulfilled the conditions attached to all the grants. RMB0.7 million was amortized from deferred government grant into government grant recognized in income in the six months ended September 30, 2023, compared to RMB0.7 million for the six months ended September 30, 2022. RMB1.5 million will be amortized in next 12 months ended September 30, 2024 which was included in the current deferred government grant and RMB18.4 million will be amortized after September 2024 which was included in the non-current portion of deferred government grants. RMB0.3 million was recorded as government grant recognized in income for the six months ended September 30, 2023, compared to nil for the six months ended September 30, 2022.

YS BIOPHARMA CO., LTD AND SUBSIDIARIES
NOTES TO THE CONDENSED CONSOLIDATED FINANCIAL STATEMENTS
September 30, 2023 and March 31, 2023

NOTE 17 — DEFERRED GOVERNMENT GRANTS (cont.)***Government grants for research and development***

YS Group has one deferred government grant for various R&D projects, and fulfilled the conditions attached to it in 2010. RMB0.8 million will be amortized in next 12 months ended September 30, 2024 which was included in the current deferred government grant and RMB4.1 million will be amortized after September 2024 which was included in the non-current portion of deferred government grants. RMB2.5 million was recorded as government grant recognized in income for the six months ended September 30, 2023, compared to nil for the six months ended September 30, 2022.

NOTE 18 — COMMITMENTS AND CONTINGENCIES

As of September 30, 2023, YS Group has the following commitments to purchase raw materials:

	2023	2023
	(RMB)	(US\$)
Research and development	143,463,250	19,981,511
Purchase raw materials	25,563,268	\$ 3,560,443
Total	169,026,518	\$ 23,541,954

In 2018, Liaoning Yisheng filed a sales contract dispute with Hebei Defense Biological Products Supply Center. The Supreme People's Court of Liaoning supported the Liaoning Yisheng's claim the defendant Hebei Weifang should pay RMB2,465,807 for Liaoning Yisheng vaccine within 20 days after the judgment came into effect. As of the date of this report, YS Group received RMB1,636,755 from Hebei Defense Biological Products Supply Center, and the balance of RMB829,052 may be received in fiscal 2024.

In 2023, Liaoning Yisheng was involved in a dispute with Shenyang Haoyu Landscape Engineering Co., Ltd ("Shenyang Haoyu") for the greening construction. In December, 2023, Shenyang Shenbei New District People's Court of Liaoning supported Shenyang Haoyu's claim that Liaoning Yisheng should pay RMB73,601. To the date, YS Group paid RMB73,601 to Shenyang Haoyu.

In March 2023, Beijing Yisheng filed a technology transfer contract dispute with Tianjin Hemu Jianmin Biotechnology Co., Ltd ("Tianjin Hemu Jianmin") to Tianjin Arbitration Commission. Beijing Yisheng claimed Tianjin Hemu Jianmin should refund RMB1.0 million and the contract should terminate. In December, 2023, Tianjin Arbitration Commission supported Beijing Yisheng's claim of terminating the contract. Beijing Yisheng is considering applying for dismissal from Tianjin Second Intermediate People's Court. As the proceedings are in the early stages, there is uncertainty regarding the timing or ultimate resolution of such matters, and therefore, an estimate for the reasonably possible gain or a range of reasonably possible gains cannot be made.

In October, 2023, Liaoning Yisheng filed an engineering dispute with Shenyang Baimu Technology Co., Ltd ("Shenyang Baimu"), claiming Shenyang Baimu should pay a penalty of RMB2,180,000 for engineering delays and refund the overpaid funds. As the proceedings are in the early stages, there is uncertainty regarding the timing or ultimate resolution of such matters, and therefore, an estimate for the reasonably possible gain or a range of reasonably possible gains cannot be made.

YS Group was also involved in labor disputes as of September 30, 2023. As the proceedings are in the early stages or the second appeal, there is uncertainty regarding the timing or ultimate resolution of such matters, and therefore, an estimate for the reasonably possible loss or a range of reasonably possible losses cannot be made.

YS BIOPHARMA CO., LTD AND SUBSIDIARIES
NOTES TO THE CONDENSED CONSOLIDATED FINANCIAL STATEMENTS
September 30, 2023 and March 31, 2023

NOTE 18 — COMMITMENTS AND CONTINGENCIES (cont.)

On December 27, 2023, HK Yisheng received a letter from R-Bridge (the “R-Bridge Letter”), notifying the Company that they have reason to believe that HK Yisheng has defaulted under financial covenants and other obligations under the facility agreement, and under the instructions of the lenders to urge the Company to consider and reach an amicable solution with the lenders, including, without limitation, repaying the loan in full, as soon as possible. In response to the R-Bridge Letter, management has provided the financial information to R-Bridge at its request and is currently working with the lenders under the facility agreement to negotiate a resolution. Management believes that, our current cash position, coupled with various measures being taken by us, such as increase product sales, strengthen the accounts receivable management and improve the ability of debt and equity financing to improve liquidity, will allow us to meet the working capital needs in the ordinary course of business. However, if lenders under the facility agreement are not satisfied and insist that we have defaulted under the facility agreement, such lenders may declare that all or part of the loan, the accrued interest, and all other amounts accrued or outstanding be immediately due and payable. If such lenders demand the prepayment of the loan in its full amount of \$40 million, the Company may be forced to seek additional funding to meet its obligation under the facility agreement, otherwise it may not be able to continue as a going concern.

NOTE 19 — SEGMENT INFORMATION

Based on management’s assessment, YS Group has one operating segment, which is the development, production, marketing and sale of biopharmaceutical products. No operating segments were aggregated to form the reportable operating segment.

YS Group’s non-current assets are located in the PRC and other countries, such as Singapore and US. The location of these non-current assets is aggregated to form the reportable geographical segment.

	March 31, 2023	September 30, 2023	September 30, 2023
	(RMB)	(RMB)	(US\$)
		(Unaudited)	(Unaudited)
PRC	645,210,788	631,678,369	\$ 87,979,939
Other countries/regions	4,602,447	4,638,477	\$ 646,045

The non-current asset information above is based on the location of the assets and excludes financial instruments and deferred tax assets.

NOTE 20 — SUBSEQUENT EVENTS

YS Group performed an evaluation of events and transactions for potential recognition or disclosure through the date of this report. YS Group is not aware of any material subsequent events other than those disclosed below and elsewhere in the notes to the consolidated financial statements.

As the Company disclosed in its previous filings with the Securities Exchange Commission, the Board has appointed Dr. Ajit Shetty, an independent director of the Company, as an interim Chairperson of the Board for a six-month period to replace Mr. Yi Zhang, effective from December 9, 2023. On December 21, 2023, the Board established a special committee comprised of Dr. Ajit Shetty (interim chairperson of the Board and independent director), Dr. Viren Mehta (independent director) and Dr. Hui Shao (director and chief executive officer of the Company) (the “Special Committee”), with powers and authorities to, among other things, commence legal proceedings in the Cayman Islands regarding invalid actions to convene an extraordinary general meeting of the Company. On January 8, 2024, the Board approved Ms. Rui Yu as the new Chairperson of its Audit Committee, as a member of its Compensation Committee, and as a member of the Nominating and Corporate Governance Committee with immediate effect.

On November 21, 2023, YS Group borrowed RMB7.1 million with interest at 4.5% from China Guangfa Bank Co, Ltd. Shenyang Branch. The loan are due on September 10, 2024.

YS BIOPHARMA CO., LTD AND SUBSIDIARIES
NOTES TO THE CONDENSED CONSOLIDATED FINANCIAL STATEMENTS
September 30, 2023 and March 31, 2023

NOTE 20 — SUBSEQUENT EVENTS (cont.)

From November 27, 2023 to January 16, 2024, YS Group borrowed RMB18.7 million with interest at 4.0% from Minsheng Bank Shenyang Huanghe Street Branch. The loan are due from November, 2024 to January, 2025.

From October 12, 2023 to December 12, 2023, YS Group borrowed RMB49 million with interest at 4.0% from Shanghai Pudong Development Bank Co., Ltd. Shenyang Branch. The loans are due from March, 2024 to November, 2025.

On October 17, 2023, YS Group borrowed RMB1.9 million with interest at 4.0% from China Construction Bank Shenyang Heping Branch. The loan is due on October 15, 2025. On November 15, 2023, YS Group also borrowed RMB2.9 million with interest at 4.0% from the same bank. The loan is due on November 14, 2025.

On November 15, 2023, YS Group borrowed RMB6.9 million with interest at 4.55% from China CITIC Bank Shenyang Tiexi Branch. The loans are due in May, 2024, November, 2024, May 2025 and November, 2025 respectively. On January 8, 2024, YS Group borrowed RMB4.5 million with interest at 4.55% from China CITIC Bank Shenyang Tiexi Branch. The loans will be due in July, 2024, January, 2025, July 2025 and January, 2026, respectively.

On December 6, 2023, YS Group borrowed RMB4.8 million with interest at 4.0% from Minsheng Bank Shenyang Huanghe Street Branch. The loan is due on December 6, 2024.

On December 12, 2023, YS Group borrowed RMB5.0 million with interest at 4.0% from Shanghai Pudong Development Bank Shenyang Branch. The loan is due on December 11, 2024.

NOTE 21 — PARENT COMPANY ONLY CONDENSED FINANCIAL INFORMATION (UNAUDITED)

Pursuant to the requirements of Rule 12-04(a), 5-04(c) and 4-08(e)(3) of Regulation S-X, the condensed financial information of the parent company shall be filed when the restricted net assets of consolidated subsidiaries exceed 25% of consolidated net assets as of the end of the most recently completed fiscal year. YS Group performed a test on the restricted net assets of consolidated subsidiaries in accordance with such requirement and concluded it was applicable to YS Group as the restricted net assets of YS Group's PRC subsidiaries exceeded 25% of the consolidated net assets of YS Group. Therefore, the condensed financial statements of the parent company are included herein.

YS BIOPHARMA CO., LTD AND SUBSIDIARIES
NOTES TO THE CONDENSED CONSOLIDATED FINANCIAL STATEMENTS
September 30, 2023 and March 31, 2023

NOTE 21 — PARENT COMPANY ONLY CONDENSED FINANCIAL INFORMATION (UNAUDITED)
(cont.)

PARENT COMPANY BALANCE SHEETS

	March 31, 2023	September 30, 2023	September 30, 2023
	(RMB)	(RMB)	(US\$)
		(Unaudited)	(Unaudited)
ASSETS			
Current Assets			
Cash	3,045,660	200,226,800	\$ 27,887,518
Prepaid expenses and other current assets	—	3,467,843	483,000
Amounts due from subsidiaries	1,039,986,896	874,990,142	121,868,317
Total current assets	1,043,032,556	1,078,684,785	150,238,835
Non-current assets			
Long-term investments, net	158,734,357	165,851,381	23,099,722
Total non-current assets	158,734,357	165,851,381	23,099,722
Total Assets	1,201,766,913	1,244,536,166	\$ 173,338,557
LIABILITIES AND EQUITY			
Current Liabilities			
Accrued expenses and other liabilities	461,105,636	681,685,969	\$ 94,944,980
Warrants liability	8,792,389	2,185,122	304,343
Amounts due to subsidiaries	3,415,603	3,568,745	497,054
Total current liabilities	473,313,628	687,439,836	95,746,377
Total Liabilities	473,313,628	687,439,836	95,746,377
Shareholders' equity:			
Ordinary shares, par value US\$0.00002 per share; 9,950,000,000 shares authorized; 93,058,197 shares issued and outstanding;	12,297	12,297	1,713
Additional paid-in capital	2,656,891,036	2,656,891,036	370,050,842
Accumulated deficit	(1,874,037,965)	(2,048,560,763)	(285,322,817)
Accumulated other comprehensive loss	(54,412,083)	(51,246,240)	(7,137,558)
Total shareholders' equity	728,453,285	557,096,330	77,592,180
Total liabilities and shareholders' equity	1,201,766,913	1,244,536,166	\$ 173,338,557

YS BIOPHARMA CO., LTD AND SUBSIDIARIES
NOTES TO THE CONDENSED CONSOLIDATED FINANCIAL STATEMENTS
September 30, 2023 and March 31, 2023

NOTE 21 — PARENT COMPANY ONLY CONDENSED FINANCIAL INFORMATION (UNAUDITED)
(cont.)

PARENT COMPANY STATEMENTS OF OPERATIONS AND COMPREHENSIVE LOSS

	Six Months Ended September 30,		
	2022	2023	2023
	(RMB)	(RMB)	(US\$)
	(Unaudited)	(Unaudited)	(Unaudited)
Equity loss of subsidiaries	(5,703,582)	(172,494,083)	\$ (24,024,916)
Operating expenses:			
General and administrative	6,356,204	10,798,610	1,504,027
Research and development	(934,367)	—	—
Total operating expenses	5,421,837	10,798,610	1,504,027
Loss from operations	(11,125,419)	(183,292,693)	(25,528,943)
Other income:			
Interest income	54	1,918,587	267,220
Fair value changes of warrant liability	—	6,851,308	954,248
Total other income, net	54	8,769,895	1,221,468
Net loss	(11,125,365)	(174,522,798)	(24,307,475)
Accretion to redemption value of convertible redeemable preferred shares	(72,083,238)	—	—
Net loss attributable to YS Biopharma	(83,208,603)	(174,522,798)	(24,307,475)
Net loss	(11,125,365)	(174,522,798)	(24,307,475)
Foreign currency translation (loss) gain	(168,653,952)	3,165,843	440,937
Total comprehensive loss	(179,779,317)	(171,356,955)	\$ (23,866,538)
Loss per share*:			
– Basic and Diluted	(0.18)	(1.88)	\$ (0.26)
Weighted average number of ordinary shares outstanding*:			
– Basic and Diluted	61,785,466	93,058,197	93,058,197

* Gives retroactive effect to reflect the reorganization in February 2021 and business combination in March 2023.

YS BIOPHARMA CO., LTD AND SUBSIDIARIES
NOTES TO THE CONDENSED CONSOLIDATED FINANCIAL STATEMENTS
September 30, 2023 and March 31, 2023

NOTE 21 — PARENT COMPANY ONLY CONDENSED FINANCIAL INFORMATION (UNAUDITED)
(cont.)

PARENT COMPANY STATEMENTS OF CASH FLOWS

	Six Months Ended September 30,		
	2022	2023	2023
	(RMB)	(RMB)	(US\$)
	(Unaudited)	(Unaudited)	(Unaudited)
Net loss	(11,125,365)	(174,522,798)	\$ (24,307,475)
Equity loss of subsidiaries	5,703,582	172,494,083	24,024,915
Share-based compensation	(85,316)	—	—
Fair value changes of warrant liability	—	(6,851,308)	(954,248)
Changes in operating assets and liabilities:			
Amounts due from subsidiaries	(328,910,623)	164,996,754	22,980,689
Amounts due to subsidiaries	373,586	153,142	21,330
Prepaid expenses and other current assets	—	(3,467,843)	(483,000)
Accrued expenses and other liabilities	55,467,639	37,562,847	5,231,740
Net cash (used in) provided by operating activities	(278,576,497)	190,364,877	26,513,951
Effect of exchange rate on cash	29,908,137	6,816,263	949,369
Net (decrease) increase in cash	(248,668,360)	197,181,140	27,463,320
Cash at the beginning of the period	252,611,535	3,045,660	424,198
Cash at the end of the period	3,943,175	200,226,800	\$ 27,887,518
Non-cash transactions:			
Accretion to redemption value of convertible redeemable preferred shares	72,083,238	—	\$ —



REPORT OF INDEPENDENT REGISTERED PUBLIC ACCOUNTING FIRM

• **MAIN OFFICE**
133-10 39TH Avenue
Flushing, NY 11354
Tel. (718) 445-6308
Fax. (718) 445-6760

• **CALIFORNIA OFFICE**
440 E Huntington Drive
Suite 300
Arcadia, CA 91006
Tel. (626) 282-1630
Fax. (626) 282-9726

• **BEIJING OFFICE**
11/F North Tower
Beijing Kerry Centre
1 Guanghua Road
Chaoyang District
Beijing, 100020, PRC
Tel. (86 10) 65997923
Fax. (86 10) 65999100

To the Board of Directors and Shareholders of
YS Biopharma Co., Ltd.

Opinion on the Financial Statements

We have audited the accompanying consolidated balance sheets of YS Biopharma Co., Ltd. (formerly, YishengBio Co., Ltd.) and Subsidiaries (the “Company”) as of March 31, 2023 and 2022, and the related consolidated statements of operations and comprehensive loss, changes in shareholders’ (deficit)/equity, and cash flows for each of the years in the three-year period ended March 31, 2023, and the related notes (collectively referred to as the financial statements). In our opinion, the financial statements present fairly, in all material respects, the financial position of the Company as of March 31, 2023 and 2022, and the results of its operations and its cash flows for each of the years in the three-year period ended March 31, 2023, in conformity with accounting principles generally accepted in the United States of America.

Convenience Translation

Our audits also comprehended the translation of Renminbi amounts into United States dollar amounts and, in our opinion, such translation was made in conformity with the basis stated in Note 3 to the financial statements. Such United States dollar amounts are presented solely for the convenience of readers outside the People’s Republic of China.

Basis for Opinion

These financial statements are the responsibility of the Company’s management. Our responsibility is to express an opinion on the Company’s financial statements based on our audits. We are a public accounting firm registered with the Public Company Accounting Oversight Board (United States) (PCAOB) and are required to be independent with respect to the Company in accordance with the U.S. federal securities laws and the applicable rules and regulations of the Securities and Exchange Commission and the PCAOB.

We conducted our audits in accordance with the standards of the PCAOB. Those standards require that we plan and perform the audit to obtain reasonable assurance about whether the financial statements are free of material misstatement, whether due to error or fraud. The Company is not required to have, nor were we engaged to perform, an audit of its internal control over financial reporting. As part of our audits, we are required to obtain an understanding of internal control over financial reporting, but not for the purpose of expressing an opinion on the effectiveness of the Company’s internal control over financial reporting. Accordingly, we express no such opinion.

Our audits included performing procedures to assess the risks of material misstatement of the financial statements, whether due to error or fraud, and performing procedures that respond to those risks. Such procedures included examining, on a test basis, evidence regarding the amounts and disclosures in the financial statements. Our audits also included evaluating the accounting principles used and significant estimates made by management, as well as evaluating the overall presentation of the financial statements. We believe that our audits provide a reasonable basis for our opinion.

/s/ Wei, Wei & Co., LLP

Flushing, New York
July 26, 2023

We have served as the Company’s auditor since 2022.

YS BIOPHARMA CO., LTD AND SUBSIDIARIES
CONSOLIDATED BALANCE SHEETS

	As of March 31,		
	2022	2023	2023
	(RMB)	(RMB)	(US\$)
ASSETS			
Current assets			
Cash	271,067,503	370,108,059	\$ 53,859,752
Restricted cash	—	261,766	38,093
Accounts receivable, net	308,555,105	463,051,792	67,385,333
Advance to suppliers, net	10,648,306	6,763,326	984,229
Inventories, net	166,505,565	185,380,952	26,977,451
Prepaid expenses and other current assets	7,987,914	10,412,769	1,515,312
Total current assets	764,764,393	1,035,978,664	150,760,170
Non-current assets			
Property, plant and equipment, net	550,153,110	571,756,443	83,204,512
Operating lease right-of-use assets, net	14,850,283	11,132,428	1,620,040
Deferred tax assets, net	3,039,084	1,905,581	277,309
Intangible assets, net	80,717,978	78,056,792	11,359,168
Other assets, non-current	28,228,293	20,923,703	3,044,909
Total non-current assets	676,988,748	683,774,947	99,505,938
Total assets	1,441,753,141	1,719,753,611	\$ 250,266,108
LIABILITIES, MEZZANINE EQUITY AND SHAREHOLDERS' (DEFICIT)/EQUITY			
Current liabilities			
Bank loans and other borrowings – current	111,733,754	193,736,563	\$ 28,193,397
Accounts payable	30,811,100	80,439,489	11,705,908
Accrued expenses and other liabilities	326,751,353	377,536,644	54,940,793
Operating lease liabilities – current	4,322,252	4,753,547	691,757
Deferred government grants – current	2,295,701	2,295,701	334,081
Total current liabilities	475,914,160	658,761,944	95,865,936
Non-current liabilities			
Bank loans and other borrowings – non-current	253,928,000	293,790,596	42,753,699
Operating lease liabilities – non-current	10,605,260	6,348,890	923,918
Deferred government grants – non-current	30,053,517	23,606,507	3,435,323
Warrants liability	—	8,792,389	1,279,507
Total non-current liabilities	294,586,777	332,538,382	48,392,447
Total liabilities	770,500,937	991,300,326	144,258,383
Mezzanine equity			
Series A and Series A-1 redeemable convertible preferred shares (par value US\$0.000005 per share, 50,000,000 shares authorized; 21,548,589 shares issued and outstanding)	458,074,468	—	—
Series B redeemable convertible preferred shares (par value US\$0.000005 per share, 100,000,000 shares authorized; 65,414,858 shares issued and outstanding)	912,146,924	—	—
Total mezzanine equity	1,370,221,392	—	—

YS BIOPHARMA CO., LTD AND SUBSIDIARIES
CONSOLIDATED BALANCE SHEETS — (Continued)

	As of March 31,		
	2022	2023	2023
	(RMB)	(RMB)	(US\$)
Shareholders' (deficit)/equity			
Ordinary shares, par value US\$0.00002 per share; 9,950,000,000 shares authorized; 61,827,883 and 93,058,197 shares issued and outstanding as of March 31, 2022 and 2023, respectively;*	7,978	12,297	1,790
Additional paid-in capital	808,502,018	2,656,891,036	386,642,466
Accumulated deficit	(1,590,567,163)	(1,874,037,965)	(272,718,245)
Accumulated other comprehensive income/(loss)	83,087,979	(54,412,083)	(7,918,286)
Total shareholders' (deficit)/equity	(698,969,188)	728,453,285	106,007,725
Total liabilities, mezzanine equity and shareholders' (deficit)/equity	1,441,753,141	1,719,753,611	\$ 250,266,108

* Gives retroactive effect to reflect the reorganization in February 2021 and business combination in March 2023.

The accompanying notes are an integral part of these consolidated financial statements.

YS BIOPHARMA CO., LTD AND SUBSIDIARIES
CONSOLIDATED STATEMENTS OF OPERATIONS AND COMPREHENSIVE LOSS

	Years Ended March 31,			
	2021	2022	2023	2023
	(RMB)	(RMB)	(RMB)	(US\$)
Revenues	257,015,929	502,949,894	687,201,070	\$ 100,004,521
Cost of revenues	59,656,877	117,066,090	153,360,262	22,317,660
Gross profit	197,359,052	385,883,804	533,840,808	77,686,861
Operating expenses:				
Selling and marketing	73,485,259	185,999,704	272,927,356	39,717,589
General and administrative	155,334,386	107,620,500	81,595,277	11,874,103
Research and development	94,387,144	211,222,263	318,700,526	46,378,702
Total operating expenses	323,206,789	504,842,467	673,223,159	97,970,394
Loss from operations	(125,847,737)	(118,958,663)	(139,382,351)	(20,283,533)
Other income (expenses):				
Late fees related to income tax	(11,464,741)	—	—	—
Late fees related to taxes other than income tax	(7,261,947)	(231,231)	(3,603)	(524)
Late fees related to social security insurance	(7,701,793)	(1,852,378)	(747,609)	(108,795)
Government grants	3,530,405	23,020,413	26,072,517	3,794,187
Financial expenses, net	(29,689,927)	(2,717,433)	(30,857,673)	(4,490,544)
Fair value changes of warrant liability	—	—	21,358	3,108
Other income (expense), net	4,063,743	(327,987)	551,760	80,295
Total other (expense) income, net	(48,524,260)	17,891,384	(4,963,250)	(722,273)
Loss before income taxes	(174,371,997)	(101,067,279)	(144,345,601)	(21,005,806)
Income tax expense	(17,454,245)	(4,937,122)	(1,133,504)	(164,952)
Net loss	(191,826,242)	(106,004,401)	(145,479,105)	(21,170,758)
Accretion to redemption value of convertible redeemable preferred shares	(16,610,297)	(130,662,326)	(137,991,697)	(20,081,159)
Net loss attributable to YS Group	(208,436,539)	(236,666,727)	(283,470,802)	\$ (41,251,917)
Net loss	(191,826,242)	(106,004,401)	(145,479,105)	\$ (21,170,758)
Other comprehensive income (loss): foreign currency translation adjustment	22,455,217	38,864,606	(137,500,062)	(20,009,614)
Total comprehensive loss	(169,371,025)	(67,139,795)	(282,979,167)	\$ (41,180,372)
Loss per share*:				
– Basic and Diluted	(3.10)	(1.71)	(1.56)	\$ (0.23)
Weighted average number of ordinary shares outstanding*:				
– Basic and Diluted	61,827,883	61,827,883	93,058,197	93,058,197

* Gives retroactive effect to reflect the reorganization in February 2021 and business combination in March 2023.

The accompanying notes are an integral part of these consolidated financial statements.

YS BIOPHARMA CO., LTD AND SUBSIDIARIES
CONSOLIDATED STATEMENTS OF CHANGES IN SHAREHOLDERS' (DEFICIT)/EQUITY

	Years Ended March 31,					
	Ordinary shares*		Additional paid-in capital	Deficit	Accumulated other comprehensive income/(loss)	Total stockholders' (deficit)/equity
	Shares	Amount				
		(RMB)	(RMB)	(RMB)	(RMB)	(RMB)
Balance as of March 31, 2020	53,220,905	6,797	276,368,115	(1,145,463,897)	21,768,156	(847,320,829)
Shareholders' contribution	8,606,978	1,181	447,681,763	—	—	447,682,944
Accretion to redemption value of convertible redeemable preferred shares	—	—	—	(16,610,297)	—	(16,610,297)
Net loss	—	—	—	(191,826,242)	—	(191,826,242)
Share-based compensation	—	—	76,756,500	—	—	76,756,500
Foreign currency translation adjustment	—	—	—	—	22,455,217	22,455,217
Balance as of March 31, 2021	61,827,883	7,978	800,806,378	(1,353,900,436)	44,223,373	(508,862,707)
Accretion to redemption value of convertible redeemable preferred shares	—	—	—	(130,662,326)	—	(130,662,326)
Net loss	—	—	—	(106,004,401)	—	(106,004,401)
Share-based compensation	—	—	7,764,448	—	—	7,764,448
Foreign currency translation adjustment	—	—	(68,808)	—	38,864,606	38,795,798
Balance as of March 31, 2022	61,827,883	7,978	808,502,018	(1,590,567,163)	83,087,979	(698,969,188)
Accretion to redemption value of convertible redeemable preferred shares	—	—	—	(137,991,697)	—	(137,991,697)
Net loss	—	—	—	(145,479,105)	—	(145,479,105)
Conversion of mezzanine equity	21,740,862	3,007	1,636,894,077	—	—	1,636,897,084
Share-based compensation	(143,750)	(20)	3,505,021	—	—	3,505,001
Issuance of common stock	9,633,202	1,332	216,376,861	—	—	216,378,193
Warrant from business combination	—	—	(8,870,007)	—	—	(8,870,007)
Additional paid-in capital from business combination	—	—	483,066	—	—	483,066
Foreign currency translation adjustment	—	—	—	—	(137,500,062)	(137,500,062)
Balance as of March 31, 2023 (in RMB)	93,058,197	12,297	2,656,891,036	(1,874,037,965)	(54,412,083)	728,453,285
Balance as of March 31, 2023 (in US\$)	93,058,197	\$ 1,790	\$ 386,642,466	\$ (272,718,245)	\$ (7,918,286)	\$ 106,007,725

* Gives retroactive effect to reflect the reorganization in February 2021 and business combination in March 2023.

The accompanying notes are an integral part of these consolidated financial statements.

YS BIOPHARMA CO., LTD AND SUBSIDIARIES
CONSOLIDATED STATEMENTS OF CASH FLOWS

	Years Ended March 31,			
	2021	2022	2023	2023
	(RMB)	(RMB)	(RMB)	(US\$)
Cash flows from operating activities:				
Net loss	(191,826,242)	(106,004,401)	(145,479,105)	\$ (21,170,758)
Adjustments to reconcile net loss to net cash used in operating activities:				
Deferred income taxes	17,454,245	4,937,120	1,133,504	164,952
Depreciation of property, plant and equipment	22,240,060	24,475,736	29,735,024	4,327,171
Amortization of intangible assets	5,665,735	6,678,233	6,952,783	1,011,800
Loss on disposal of property, plant and equipment	24,876	273,982	—	—
Share-based compensation	76,756,500	7,764,448	3,505,001	510,063
Bad debt provision of accounts receivable	6,414,634	5,084,925	10,750,948	1,564,525
Write-down (reversal) of inventories to net realizable value	1,109,400	4,393,630	(723,583)	(105,299)
Non-cash lease expense	2,233,089	3,787,628	4,423,612	643,743
Fair value changes of warrant liability	—	—	(21,358)	(3,108)
Changes in operating assets and liabilities:				
Inventories	(68,728,378)	(89,459,313)	(18,151,804)	(2,641,530)
Accounts receivable	(220,734,141)	(99,137,291)	(165,247,635)	(24,047,562)
Amounts due from related parties	(3,086,330)	30,088,833	—	—
Prepaid expenses and other current assets	146,767,686	59,229,801	8,992,574	1,308,639
Accounts payable	(4,424,337)	14,427,864	49,628,389	7,222,141
Amounts due to related parties	(245,808)	—	—	—
Accrued expenses and other liabilities	140,210	(35,633,487)	43,029,496	6,261,841
Deferred government grants	(44,290)	(656,673)	(6,447,010)	(938,197)
Income taxes payable	(34,105,055)	—	—	—
Operating lease liabilities	(2,222,291)	(3,796,392)	(4,550,232)	(662,170)
Net cash used in operating activities	(246,610,437)	(173,545,357)	(182,469,396)	(26,553,749)
Cash flows from investing activities:				
Proceeds from disposal of property, plant and equipment	644,842	8,000	68,001	9,896
Purchases of property, plant and equipment	(104,883,783)	(295,314,351)	(52,758,124)	(7,677,594)
Purchases of intangible assets	—	(3,617,607)	(4,291,597)	(624,532)
Net cash used in investing activities	(104,238,941)	(298,923,958)	(56,981,720)	(8,292,230)
Cash flows from financing activities:				
Proceeds from issuance of mezzanine equity	729,412,999	—	—	—
Shareholders' contribution	1,589,236	—	—	—
Proceeds from business combination	—	—	252,457,329	36,738,701
Offering cost	—	—	(35,884,661)	(5,222,094)
Proceeds from bank loans and other borrowings	32,253,609	414,116,587	247,387,392	36,000,901
Repayment of bank loans and other borrowings	(160,407,571)	(49,558,442)	(146,510,134)	(21,320,799)
Proceeds from borrowings from related parties	299,757,219	—	—	—
Repayment of borrowings from related parties	(163,346,796)	—	—	—
Net cash provided by financing activities	739,258,696	364,558,145	317,449,926	46,196,709

YS BIOPHARMA CO., LTD AND SUBSIDIARIES
CONSOLIDATED STATEMENTS OF CASH FLOWS — (Continued)

	Years Ended March 31,			
	2021	2022	2023	2023
	(RMB)	(RMB)	(RMB)	(US\$)
Effect of foreign exchange rate on cash	(2,674)	(11,478,411)	21,303,512	3,100,180
Net increase (decrease) in cash	388,406,644	(119,389,581)	99,302,322	14,450,910
Cash at the beginning of the year	2,050,440	390,457,084	271,067,503	39,446,935
Cash at the end of the year	<u>390,457,084</u>	<u>271,067,503</u>	<u>370,369,825</u>	<u>\$ 53,897,845</u>
Supplemental disclosures of cash flow information:				
Income taxes paid	<u>34,105,055</u>	<u>—</u>	<u>—</u>	<u>—</u>
Interest paid	<u>8,124,572</u>	<u>2,404,357</u>	<u>27,289,057</u>	<u>\$ 3,971,224</u>
Non-cash transactions:				
Accretion to redemption value of convertible redeemable preferred shares	<u>16,610,297</u>	<u>130,662,326</u>	<u>137,991,697</u>	<u>\$ 20,081,159</u>
Operating right-of-use assets recognized for related operating lease liabilities	<u>15,048,446</u>	<u>1,516,478</u>	<u>331,218</u>	<u>\$ 48,200</u>
Forgiveness of amounts due to related parties	<u>446,092,527</u>	<u>—</u>	<u>—</u>	<u>—</u>
Equity transaction from warrants	<u>—</u>	<u>—</u>	<u>(8,870,007)</u>	<u>\$ (1,290,802)</u>
Equity transaction from preferred shares	<u>—</u>	<u>—</u>	<u>1,636,897,084</u>	<u>\$ 238,208,461</u>

The accompanying notes are an integral part of these consolidated financial statements.

YS BIOPHARMA CO., LTD AND SUBSIDIARIES
NOTES TO THE CONSOLIDATED FINANCIAL STATEMENTS
March 31, 2021, 2022 and 2023

NOTE 1 — ORGANIZATION AND BUSINESS DESCRIPTION

YS Biopharma Co., Ltd (“YS Biopharma”), formerly known as Yisheng Bio Co., Ltd (with the name changed March 16, 2023), was incorporated under the laws of the Cayman Islands as an exempted company with limited liability in November 2020. It owns four companies and their subsidiaries that were incorporated in the Cayman Islands, United States of America (“US”), Singapore, Hong Kong and the People’s Republic of China (“China” or the “PRC”) (collectively, the “Company” or “YS Group”). YS Group is principally engaged in the research, development, manufacturing and sale of vaccines and therapeutic biologics. It developed a PIKA immunomodulating technology platform and a series of product candidates targeting rabies, hepatitis B, influenza and other indications. It is also conducting the production and sale of YSJA™ (依生君安™) rabies vaccine, the first aluminum-free lyophilized rabies vaccine launched in China.

Business Reorganization

Prior to the business reorganization completed in February 2021, YS Group conducted its business under Yisheng Biopharma Co., Ltd (“Yisheng Biopharma”), a Cayman Islands company established in April 2010, as an offshore holding company used by its shareholders to hold and control its business operation. Before or after the reorganization, both YS Biopharma and Yisheng Biopharma are controlled by the same major shareholder, Yi Zhang, founder of YS Group and Yisheng Biopharma.

In February 2021, YS Group’s business and technology segments were separated and spun-off from the parent company of Yisheng Biopharma Co., Ltd. by a series of corporate and business restructurings. In connection with such restructurings, YishengBio (Hong Kong) Holdings Limited (“HK Yisheng”) and Beijing Yisheng Biotechnology Co., Ltd. (“Beijing Yisheng”) were established under the laws of Hong Kong in December 2020 and the PRC in February 2021, respectively. In January 2021 and February 2021, Liaoning Yisheng Biopharma Co., Ltd. (“Liaoning Yisheng”) and Beijing Yisheng became wholly-owned subsidiaries of HK Yisheng in December 2020, YS Biopharma issued shares and entered into shareholders agreement with the then shareholders of Yisheng Biopharma to substantially mirror their respective interests in Yisheng Biopharma to YS Biopharma. In January 2021, YS Biopharma acquired all the equity interests of Yisheng US Biopharma Inc. (“US Yisheng”) and Yisheng Biopharma (Singapore) Pte. Ltd. (“Singapore Yisheng”) from Yisheng Biopharma, both of which became wholly-owned subsidiaries of YS Biopharma. In February 2021, Beijing Yisheng acquired all the relevant assets and business from a Beijing subsidiary of Yisheng Biopharma. The restructuring was completed in February 2021. After the reorganization, there is no equity relationship, no business activities and no business relevance or competition between Yisheng Biopharma and YS Biopharma, and both are controlled by the same shareholder, Yi Zhang.

After the reorganization completed in February 2021, YS Group’s legal entity structure was as follows:

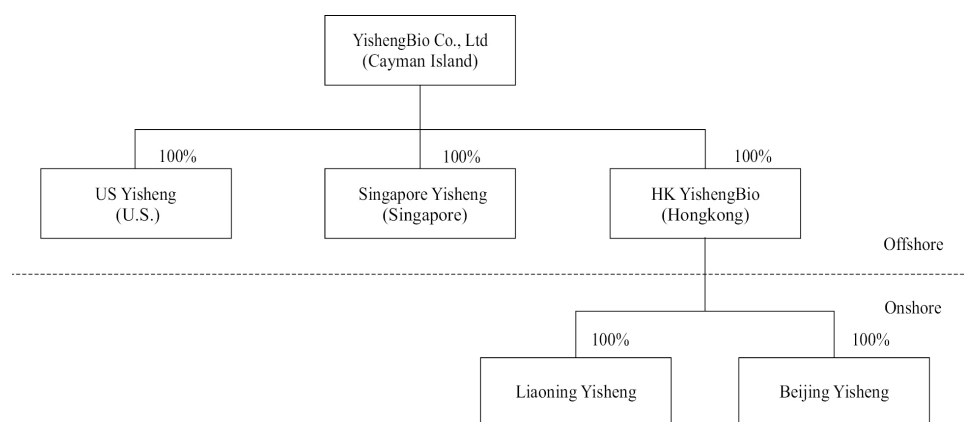

YS BIOPHARMA CO., LTD AND SUBSIDIARIES
NOTES TO THE CONSOLIDATED FINANCIAL STATEMENTS
March 31, 2021, 2022 and 2023

NOTE 1 — ORGANIZATION AND BUSINESS DESCRIPTION (cont.)

Business Combination

On August 15, 2022, Oceanview Bioscience Acquisition Co., Ltd. (“Oceanview Bioscience”) and Hudson Biomedical Group Co., Ltd. (“Hudson Biomedical”) were incorporated under the laws of Cayman Islands as exempted companies with limited liability. The companies were incorporated for the purpose of effecting a merger with Summit Healthcare Acquisition Corp, a Special Purpose Acquisition Company (“SPAC”). YS Group’s legal entity structure was as follows:

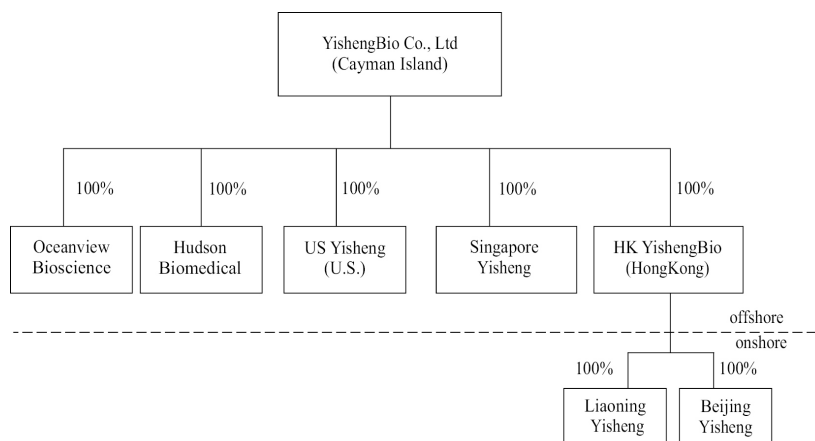

On September 29, 2022, YS Biopharma entered into the Business Combination Agreement with Summit Healthcare Acquisition Corp (“Summit”), Oceanview Bioscience Acquisition Co., Ltd., (“Merger Sub I”) and Hudson Biomedical Group Co., Ltd., (“Merger Sub II”). The Business Combination Agreement provides for (1) the merger of Merger Sub I with and into Summit (the “First Merger”), with Summit surviving the First Merger as the surviving entity (the “Surviving Entity”) and becoming a wholly-owned subsidiary of YS Biopharma, and (2) the merger of the Surviving Entity with and into Merger Sub II (the “Second Merger,” and together with the First Merger, the “Mergers,” together with other transactions contemplated by the Business Combination Agreement, the “Business Combination”), with Merger Sub II surviving the Second Merger as the surviving company (the “Surviving Company”) and remaining as a wholly-owned subsidiary of YS Biopharma.

In accordance with the Business Combination Agreement, on the date of closing of the Mergers (“First Merger and Second Merger”), (1) each YS Biopharma’s preferred share was converted into one pre-consolidation Ordinary Share; (2) every four of the pre-consolidation Ordinary Shares and every four pre-consolidation options of YS Biopharma was consolidated into one Ordinary Share and one option of YS Biopharma, respectively, subject to rounding up to the nearest whole number of Ordinary Shares.

YS BIOPHARMA CO., LTD AND SUBSIDIARIES
NOTES TO THE CONSOLIDATED FINANCIAL STATEMENTS
March 31, 2021, 2022 and 2023

NOTE 1 — ORGANIZATION AND BUSINESS DESCRIPTION (cont.)

On March 16, 2023 (the “Closing Date”), YS Biopharma announced the completion of its business combination with Summit pursuant to the above Business Combination Agreement. YS Group’s current legal entity structure is as follows:

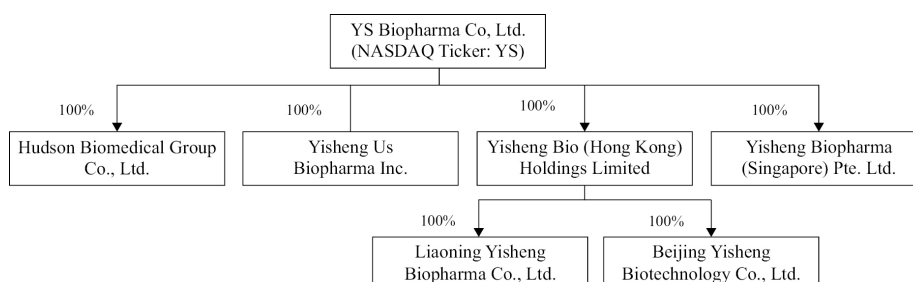

As of March 31, 2023, YS Group consists of the following legal entities:

Legal Entity	Nature of Operations	Date of Incorporation	Place of Incorporation
YS Biopharma Co., Ltd. (“YS Biopharma”) ^{***}	Holding Company	November 16, 2020	Cayman Islands
YishengBio (Hong Kong) Holdings Limited (“HK Yisheng”)	Holding Company	December 28, 2020	Hong Kong
Yisheng Biopharma (Singapore) Pte. Ltd. (“Singapore Yisheng”) ^{**}	Research and development of vaccines and therapeutic biologics	November 28, 2009	Singapore
Yisheng US Biopharma Inc. (“US Yisheng”)	Research of vaccines and therapeutic biologics	September 29, 2009	US
Liaoning Yisheng Biopharma Co., Ltd. (“Liaoning Yisheng”) [*]	Research and development, manufacturing and commercialization of vaccines and therapeutic biologics	May 26, 1994	PRC
Beijing Yisheng Biotechnology Co., Ltd. (“Beijing Yisheng”)	Research and development of vaccines and therapeutic biologics	February 4, 2021	PRC
Hudson Biomedical Group Co., Ltd.	Purpose of effecting a merger	August 15, 2022	Cayman Islands

* Liaoning Yisheng was incorporated May 26, 1994, and acquired by YS Group in fiscal 2005.

** Singapore Yisheng was incorporated November 28, 2009, and acquired by YS Group in fiscal 2011

*** YS Biopharma, formerly known as Yisheng Bio Co., Ltd with the name changed on March 16, 2023.

NOTE 2 — LIQUIDITY

As reflected in the accompanying consolidated financial statements (“CFS”), the Company reported net loss of RMB191,826,242, RMB106,004,401 and RMB145,479,105 for the years ended March 31, 2021, 2022 and 2023, respectively. And the Company reported accumulated deficit of RMB1,590,567,163 and RMB1,874,037,965 as of March 31, 2022 and 2023.

In assessing its liquidity, management monitors and analyzes the Company’s cash flow requirements, its ability to generate sufficient revenue sources in the future, and its operating and capital expenditure commitments. As of March 31, 2023, the Company had cash of approximately RMB370.4 million (US\$53.9 million). As of March 31, 2023, the Company had outstanding bank loans and other borrowings of approximately RMB487.5 million (US\$70.9 million) from various financial institutions.

YS BIOPHARMA CO., LTD AND SUBSIDIARIES
NOTES TO THE CONSOLIDATED FINANCIAL STATEMENTS
March 31, 2021, 2022 and 2023

NOTE 2 — LIQUIDITY (cont.)

Currently, the Company is working to improve its liquidity and capital sources primarily through debt and equity financing. Based on the Company's current operating plan, management believes the above-mentioned measures collectively will provide sufficient liquidity for YS Group to meet its future liquidity and capital requirement for at least 12 months from the date of this report.

NOTE 3 — SUMMARY OF SIGNIFICANT ACCOUNTING POLICIES

Basis of Presentation

These CFS and related notes of YS Group were prepared in accordance with accounting principles generally accepted in the United States of America ("GAAP") and the rules and regulations of the U.S. Securities and Exchange Commission ("SEC"). In the opinion of management, all adjustments necessary to present fairly in all material respects the financial position, results of operations and cash flows for all periods presented were made.

Basis of Consolidation

The CFS include the financial statements of YS Group and its wholly-owned subsidiaries. All significant intercompany transactions and balances were eliminated in consolidation. The CFS were prepared on a historical cost basis, except for financial assets and financial liabilities which were measured at fair value ("FV"). The functional currency of YS Group and its Hong Kong subsidiary, US subsidiary is the United States dollars ("US\$"). The functional currency of YS Group's Singapore subsidiary is the Singapore dollars ("S\$"). The functional currency of YS Group's PRC subsidiaries is the Chinese Renminbi ("RMB"). The determination of functional currency is based on the criteria of Accounting Standard Codifications ("ASC") as promulgated by the Financial Accounting Standards Board, ASC 830, Foreign Currency Matters ("ASC 830"). YS Group uses the RMB as its reporting currency.

The business reorganization as described in Note 1 was treated as a recapitalization of entities under common control and the accompanying CFS of YS Group give retroactive effect to this transaction.

Use of Estimates

The preparation of the CFS in conformity with GAAP requires management to make estimates and assumptions that affect the reported amounts of assets and liabilities and disclosure of contingent assets and liabilities at the date of the CFS and the reported amounts of revenues and expenses during the reporting periods. Significant estimates and assumptions reflected in these CFS include, but are not limited to, the valuation of YS Group's convertible redeemable preferred shares and ordinary shares, accrual of stock-based compensation expense, allowance for doubtful accounts and obsolete inventories, useful life of property, plant and equipment, income taxes and uncertain tax positions. Actual amounts could differ from those estimates. Changes in estimates are recorded in the period when they become known. Due to the risks and uncertainties involved in YS Group's business and evolving market conditions and, given the subjective element of the estimates and assumptions made, actual results may differ from estimated results.

Foreign Currency Translation

YS Group's CFS are reported using the RMB. The results of operations and the consolidated statements of cash flows denominated in foreign currency are translated at the average rate of exchange during the reporting period. Assets and liabilities denominated in foreign currencies at the balance sheet date are translated at the applicable rates of exchange in effect at that date. The equity denominated in the functional currency is translated at the historical rate of exchange at the time of capital transaction. Because cash flows are translated based on the average translation rate, amounts related to assets and liabilities reported on the consolidated statements of cash flows will not necessarily agree with changes in the corresponding balances on the consolidated balance sheets. Foreign currency translation adjustments arising from the use of different exchange rates from period to period are included as a separate component of accumulated

YS BIOPHARMA CO., LTD AND SUBSIDIARIES
NOTES TO THE CONSOLIDATED FINANCIAL STATEMENTS
March 31, 2021, 2022 and 2023

NOTE 3 — SUMMARY OF SIGNIFICANT ACCOUNTING POLICIES (cont.)

other comprehensive income included in YS Group's consolidated statements of changes in shareholders' deficit. Gains and losses from foreign currency transactions are included in YS Group's consolidated statements of operations and comprehensive loss.

The value of RMB against US\$ and other currencies may fluctuate and is affected by, among other things, changes in the PRC's political and economic conditions. The following table outlines the currency exchange rates used in preparing YS Group's CFS:

Foreign currency	As of March 31,		Years Ended March 31,		
	2022	2023	2021	2022	2023
	Balance Sheet	Balance Sheet	Profit/Loss	Profit/Loss	Profit/Loss
RMB:1US\$	6.3482	6.8717	6.8282	6.4598	6.6100
RMB:1S\$	4.6932	5.1760	4.9246	4.7850	4.9346

Convenience translation

Amounts in US\$ are presented for the convenience of the reader and translated at US\$1.00 to RMB6.8717, representing the central parity rate release of the People's Bank of China on March 31, 2023. No representation is made that the RMB amounts could have been, or converted, realized or settled into US\$ at such rate.

Cash

Cash includes cash on hand and demand deposits in accounts maintained with commercial banks. YS Group maintains bank accounts in China. Cash balances in bank accounts in China are not insured by the Federal Deposit Insurance Corporation or other programs.

Restricted Cash

Restricted cash balances mainly relate to restrictions imposed on banks as cash deposits for the issuance of letters of credit. And it is included in the total cash, cash equivalents, and restricted cash in the consolidated statements of cash flows.

Accounts Receivable, net

Accounts receivable is presented net of allowance for doubtful accounts. YS Group reduces its accounts receivable by recording a bad debt allowance to account for the estimated impact of collection issues resulting from a client's inability or unwillingness to pay valid obligations to YS Group. YS Group determines the adequacy of allowance for doubtful accounts based on individual account analysis, historical collection trend, and best estimate of specific losses on individual exposures. YS Group establishes an allowance for doubtful accounts when there is objective evidence that YS Group may not be able to collect amounts due. Accounts receivable balances are written off after all collection efforts have been exhausted.

Advance to Suppliers, net

Advance to suppliers represent amounts advanced to vendors or suppliers for providing raw materials to YS Group. The suppliers usually require advance payments when YS Group orders materials and the advance will be utilized to offset YS Group's actual payment obligations. These amounts advanced are unsecured, non-interest bearing and generally short term in nature. YS Group will reduce its advance to suppliers by recording an allowance that approximates the extent of the advance that may not be realizable during the procurement process. YS Group recorded nil, nil and RMB54,870 allowance against its advance to suppliers as of March 31, 2021, 2022 and 2023.

YS BIOPHARMA CO., LTD AND SUBSIDIARIES
NOTES TO THE CONSOLIDATED FINANCIAL STATEMENTS
March 31, 2021, 2022 and 2023

NOTE 3 — SUMMARY OF SIGNIFICANT ACCOUNTING POLICIES (cont.)

Inventories, net

Inventories are stated at the lower of cost or net realizable value. Cost is determined on the weighted average basis and comprises all cost of purchase and other costs incurred in bringing the inventories to their present location and condition. Net realizable value is based on estimated selling prices less any estimated costs to be incurred to completion and disposal.

YS Group reviews the carrying amounts of the inventories on a quarterly basis to determine if the inventories are carried at lower of cost or net realizable value. The net realizable value is estimated based on current market conditions and historical experience.

Adjustments are recorded to write down the cost of inventory based on the expiration date of raw materials and the estimate of future usage. Write-downs are recorded in cost of revenue in the consolidated statements of operations and comprehensive loss.

Property, Plant and Equipment, net

Property, plant and equipment are stated at cost less accumulated depreciation and any impairment losses. The cost of property, plant and equipment comprises its purchase price and any directly attributable costs of bringing the asset to its working condition and location for its intended use.

Expenditure incurred after items of property, plant and equipment have been put into operation, such as repairs and maintenance, are expensed when incurred. In situations where the recognition criteria are satisfied, the expenditure for a major reconstruction is capitalized as a replacement. Where significant parts of property, plant and equipment are required to be replaced at intervals, YS Group recognizes such parts as individual assets with specific useful lives and depreciates them accordingly.

Depreciation is calculated on the straight-line basis to reduce the cost of each item of property, plant and equipment to its residual value over its estimated useful life.

Category	Estimated useful life
Plant and building	6 – 20 years
Machinery and equipment	5 – 10 years
Furniture and fixtures	3 – 7 years
Motor vehicle	4 – 5 years
Leasehold improvement	Lesser of the lease term or life of assets

Where parts of an item of property, plant and equipment have different useful lives, the cost of that item is allocated on a reasonable basis among the parts and each part is depreciated separately. Residual values, useful lives and the depreciation method are reviewed, and adjusted if appropriate, at least at each quarter end.

An item of property, plant and equipment including any significant part initially recognized is derecognized upon disposal or when no future economic benefits are expected from its use or disposal. Any gain or loss on disposal or retirement recognized in the statement of operations in the period the asset is derecognized is the difference between the net sales proceeds and the carrying amount of the relevant asset.

Intangible assets, net

Intangible assets acquired separately are measured on initial recognition at cost. The cost of intangible assets acquired in a business combination is the FV at the date of acquisition. The useful lives of intangible assets are assessed to be either finite or indefinite. Intangible assets with finite lives are amortized over the useful economic life and assessed

YS BIOPHARMA CO., LTD AND SUBSIDIARIES
NOTES TO THE CONSOLIDATED FINANCIAL STATEMENTS
March 31, 2021, 2022 and 2023

NOTE 3 — SUMMARY OF SIGNIFICANT ACCOUNTING POLICIES (cont.)

for impairment whenever there is an indication that the intangible asset may be impaired. The amortization period and the amortization method for an intangible asset with a finite useful life is reviewed for appropriateness at each financial year end.

Intangible assets with indefinite useful lives or not yet available for use are tested for impairment annually either individually or at the cash-generating unit level. Such intangible assets, including vaccine license and patent with indefinite useful lives, are not amortized. The useful life of an intangible asset with an indefinite life is reviewed annually to determine whether the indefinite life assessment continues to be supportable. If not, the change in the useful life assessment from indefinite to finite is accounted for on a prospective basis.

Patents with definite useful lives are stated at cost less any impairment losses and are amortized on the straightline basis over their estimated useful lives of 15 years. Software and laboratory information system are amortized on the straight-line basis over their estimated useful lives of 10 years.

An intangible asset that is determined to have an indefinite useful life is not amortized until its useful life is determined to be no longer indefinite. Management evaluates the remaining useful life of an intangible asset that is not being amortized in each reporting period to determine whether events and circumstances continue to support an indefinite useful life. Indefinite-lived intangible assets are subject to impairment testing at least annually.

Management believes that YS Group's Drug Manufacturing License that was granted by the Liaoning Food and Drug Administration ("FDA") is an intangible asset with an indefinite useful life because the certificate may be renewed indefinitely at little cost and has historically been renewed by Liaoning Yisheng. Liaoning Yisheng intends to renew the certificate indefinitely, and has the ability to do so. Cash flows from the certificate are expected to continue indefinitely. Therefore, the Drug Manufacturing License is not amortized until its estimated useful life is believed to be no longer indefinite.

All R&D costs are expensed as incurred. Expenditure incurred on projects to develop new products is capitalized and deferred only when YS Group can demonstrate the technical feasibility of completing the intangible asset so that it will be available for use or sale, its intention to complete and its ability to use or sell the asset, how the asset will generate future economic benefits, the availability of resources to complete the project and the ability to measure reliably the expenditure during the development. Product development expenditures which do not meet these criteria are expensed when incurred.

Land use rights: Land lease payments are amounts paid for the rights to use land in the PRC and are recorded net of accumulated amortization. Amortization is provided on a straight-line basis over the term of the lease agreement, which ranges from 48.75 to 50 years.

Impairment of Long-lived Assets

YS Group reviews long-lived assets, including definitive-lived intangible assets and property and equipment, for impairment whenever events or changes in circumstances indicate the carrying amount of an asset may not be recoverable. When such events occur, YS Group assesses the recoverability of the asset group based on the undiscounted future cash flows the asset group is expected to generate and recognizes an impairment loss when estimated undiscounted future cash flows expected to result from the use of the asset group plus net proceeds expected from disposition of the asset group, if any, is less than the carrying value of the asset group. If YS Group identifies an impairment, YS Group reduces the carrying amount of the asset group to its estimated fair value based on a discounted cash flow approach or, when available and appropriate, to comparable market values and the impairment loss, if any, is recognized in general and administrative expenses in the consolidated statements of operations. YS Group uses estimates and judgments in its impairment tests and if different estimates or judgments had been utilized, the timing or the amount of any impairment charges could be different. Asset groups to be disposed of would be reported at the lower of the carrying amount or fair value less costs to sell, and no longer depreciated. YS Group did not record any impairment charges during the years ended March 31, 2021, 2022 and 2023.

YS BIOPHARMA CO., LTD AND SUBSIDIARIES
NOTES TO THE CONSOLIDATED FINANCIAL STATEMENTS
March 31, 2021, 2022 and 2023

NOTE 3 — SUMMARY OF SIGNIFICANT ACCOUNTING POLICIES (cont.)

Concentrations of Credit Risk and Significant Suppliers

Financial instruments that potentially subject YS Group to concentration of credit risk consist of cash. YS Group mitigates this risk by maintaining its cash with high quality, accredited financial institutions. As of March 31, 2023, YS Group's cash was deposited at more than two financial institutions and it did not have any foreign currency exchange contracts, option contracts or other hedging arrangements. YS Group has not experienced any losses on its deposits of cash and does not believe that it is exposed to any unusual credit risk beyond the normal credit risk associated with commercial banking relationships.

YS Group's sales are made primarily to Centers for Disease Control and Prevention ("CDCs") located in China. YS Group does not have a concentration of its revenue and accounts receivable with specific customers. As of March 31, 2022 and 2023, there was no customers which accounted for more than 10% of YS Group's accounts receivable balance. During the years ended March 31, 2021, 2022 and 2023, there were no customers that accounted for more than 10% of YS Group's net revenues.

Details of percentage of YS Group's top 5 vendors accounting for total purchases are as follows:

	Year Ended March 31, 2023		
	(RMB)	(US\$)	
Vendor A	48,006,500	\$ 6,986,117	37.9%
Vendor F	15,178,020	2,208,772	12.0%
Vendor G	10,053,600	1,463,044	7.9%
Vendor H	6,846,214	996,291	5.4%
Vendor C	4,746,530	690,736	3.7%
Total	84,830,864	\$ 12,344,960	66.9%

	Year Ended March 31, 2022		
	(RMB)	(US\$)	
Vendor A	35,172,250	\$ 5,540,508	20.9%
Vendor B	16,227,146	2,556,181	9.6%
Vendor C	9,995,189	1,574,492	5.9%
Vendor D	7,426,500	1,169,859	4.4%
Vendor E	6,621,300	1,043,020	3.9%
Total	75,442,385	\$ 11,884,060	44.7%

	Year Ended March 31, 2021		
	(RMB)	(US\$)	
Vendor A	32,063,500	\$ 4,879,324	37.9%
Vendor F	5,781,888	879,870	6.8%
Vendor G	4,862,320	739,933	5.7%
Vendor C	4,568,088	695,157	5.4%
Vendor H	3,199,200	486,844	3.8%
Total	50,474,996	\$ 7,681,128	59.6%

YS BIOPHARMA CO., LTD AND SUBSIDIARIES
NOTES TO THE CONSOLIDATED FINANCIAL STATEMENTS
March 31, 2021, 2022 and 2023

NOTE 3 — SUMMARY OF SIGNIFICANT ACCOUNTING POLICIES (cont.)

Details of percentage of YS Group’s top 5 vendors accounting for accounts payable are as follows:

	As of March 31, 2023		
	(RMB)	(US\$)	
Vendor A	3,220,000	\$ 468,589	4.0%
Vendor F	420	61	0.0%
Vendor H	16,118	2,346	0.0%
Total	3,236,538	\$ 470,996	4.0%

	As of March 31, 2022		
	(RMB)	(US\$)	
Vendor E	1,420,549	\$ 223,772	4.6%
Total	1,420,549	\$ 223,772	4.6%

YS Group’s business operation has been, and may continue to be, negatively affected by the outbreak of COVID-19. While many of the restrictions on movements within China have been relaxed, there is great uncertainty around the future of the COVID-19 outbreak and how it will impact YS Group’s operations, particularly in terms of the spread of Omicron virus in China.

Fair Value Measurements

ASC 825-10 requires certain disclosures regarding the FV of financial instruments. FV is defined as the price that would be received to sell an asset or paid to transfer a liability in an orderly transaction between market participants at the measurement date. A three-level FV hierarchy prioritizes the inputs used to measure FV. The hierarchy requires entities to maximize the use of observable inputs and minimize the use of unobservable inputs. The three levels of inputs used to measure FV are as follows:

- Level 1 — inputs to the valuation methodology are quoted prices (unadjusted) for identical assets or liabilities in active markets.
- Level 2 — inputs to the valuation methodology include quoted prices for similar assets and liabilities in active markets, quoted market prices for identical or similar assets in markets that are not active, inputs other than quoted prices that are observable and inputs derived from or corroborated by observable market data.
- Level 3 — inputs to the valuation methodology are unobservable.

Unless otherwise disclosed, the FV of YS Group’s financial instruments including cash, accounts receivable, advances to suppliers, amounts due from related parties, prepaid expenses and other current assets, short-term bank loans and other loans, accounts payable, warrant liabilities, and accrued expenses and other current liabilities approximate their recorded values due to their short-term maturities. The FV of longer-term leases approximates their recorded values as their stated interest rates approximate the rates currently available.

YS Group’s non-financial assets, such as property and equipment would be measured at FV only if they were determined to be impaired.

Social Security Insurance

Employees of YS Group’s subsidiaries that operate in the PRC are required to participate in a pension scheme operated by the local municipal government. According to the Social Insurance Law of the PRC (the “Social Security Insurance Law”) promulgated by the Standing Committee of the National People’s Congress (the “Standing Committee”) that became effective on December 29, 2018, there are five basic types of social security insurance, which include: basic

YS BIOPHARMA CO., LTD AND SUBSIDIARIES
NOTES TO THE CONSOLIDATED FINANCIAL STATEMENTS
March 31, 2021, 2022 and 2023

NOTE 3 — SUMMARY OF SIGNIFICANT ACCOUNTING POLICIES (cont.)

pension, basic medical, unemployment, work-related injury and maternity insurance (collectively known as “social security insurance”). Both employees and employers make contributions for the first three kinds of social security insurance; and only employers make contributions for the latter two kinds, which means the employers must pay all or a portion of the social security insurance premiums for their employees. If YS Group does not fully comply with the relevant requirements and does not make social insurance contributions in full to the social insurance scheme for the employees of PRC affiliated entities, YS Group will be required to make up the social insurance contributions as well as to pay late fees at 0.05% per day of the outstanding amount from the due date. If YS Group fails to make up for the shortfalls within the prescribed time limit, the relevant administrative authorities could impose a fine of one to three times the outstanding amount and file applications to competent courts for compulsory enforcement of payment and deposit. No fine or compulsory enforcement had been imposed by relevant authorities in connection with the delayed payment of the social security insurance premiums by YS Group. As of March 31, 2023, 2022 and 2021, YS Group’s recorded late fees of RMB9.9 million, RMB9.5 million and RMB29.4 million, respectively, for its liabilities related to social security insurance (see Note 11).

Leases

Under ASC Topic 842, Leases (“ASC 842”), YS Group determines if an arrangement is or contains a lease at inception. For leases with a term of 12 months or less, YS Group does not recognize a right-of-use (“ROU”) asset or lease liability. YS Group’s operating leases are recognized on its consolidated balance sheets as noncurrent assets, current liabilities and noncurrent liabilities. YS Group does not have any finance leases.

ROU assets represent YS Group’s right to use an underlying asset for the lease term and lease liabilities represent YS Group’s obligation to make lease payments arising from the lease. Operating lease ROU assets and liabilities are recognized at the lease commencement date based on the present value of lease payments over the lease term. As YS Group’s leases typically do not provide an implicit rate, YS Group uses an estimate of its incremental borrowing rate based on the information available at the lease commencement date in determining the present value of lease payments. The lease terms may include options to extend or terminate the lease when it is reasonably certain that YS Group will exercise that option. Lease expense is recognized on a straight-line basis over the lease term. For leases with terms greater than 12 months, YS Group records the related asset and lease liability at the present value of lease payments over the lease term. For leases with terms less than 12 months, YS Group records rents in administrative expenses.

Government Grants

Government grants represent primarily subsidies received from PRC governments for operating a business in their jurisdictions and in compliance with specific policies promoted by the government authorities. YS Group’s PRC-based subsidiaries received specific subsidies and other subsidies from certain local governments. Specific subsidies are subsidies the local government has set certain conditions for the subsidies. Other subsidies are subsidies the local government has not set any conditions and are not tied to future trends or performance of YS Group, receipt of such subsidy is not contingent upon any further actions or performance of YS Group and the amounts do not have to be refunded under any circumstances. Specific subsidies are recorded as deferred government grants upon receipt and are recognized as government grants recognized in income when the conditions are met. Other subsidies are recognized as other income upon receipt as further performance by YS Group is not required.

Government grants for R&D are recognized as a reduction to R&D expenses when the conditions attached to the grants are met or recognized as government grants recognized in income in the period when the conditions are met after the expenses are incurred. Government grants for property, plant and equipment are deferred and recognized as a reduction to the related depreciation and amortization expenses in the same manner as the property, plant and equipment are depreciated.

YS BIOPHARMA CO., LTD AND SUBSIDIARIES
NOTES TO THE CONSOLIDATED FINANCIAL STATEMENTS
March 31, 2021, 2022 and 2023

NOTE 3 — SUMMARY OF SIGNIFICANT ACCOUNTING POLICIES (cont.)

Convertible Redeemable Preferred Shares

YS Group has two classes of preferred shares: Series A and Series B and Series A consists of Series A and Series A-1 (collectively, the “Convertible Redeemable Preferred Shares”). These Convertible Redeemable Preferred Shares are considered “probable of becoming redeemable” as one of the redemption events depends solely on the passage of time, and the shares become redeemable following the respective anniversary of the issuance date.

Since the Series A, Series A-1 and Series B Preferred Shares are redeemable at a determinable price on a determinable date, at the option of the holder, or upon occurrence of an event that depends solely on the passage of time, the Series A, they are accounted for as mezzanine equity on the consolidated balance sheets.

The mezzanine equity is carried at the higher of (1) the carrying amount after the attribution of net income of YS Group or (2) the expected redemption value. YS Group accretes the difference between the initial carrying value and the ultimate redemption price using the effective interest rate method from the issuance dates to the earliest possible redemption date.

Upon the completion of YS Group’s business combination on March 16, 2023, all the outstanding Convertible Redeemable Preferred Shares were converted into Ordinary Shares. No mezzanine equity was recognized as of March 31, 2023.

Warrants

YS Group accounts for warrants as either equity-method or liability-method instruments based on an assessment of the warrant’s specific terms and applicable authoritative guidance in ASC 480 and ASC 815. Warrants recorded as equity are recorded at their relative FV determined at the issuance date and remeasurement is not required. Warrants recorded as liabilities are recorded at their FV, within warrant liabilities on the consolidated balance sheets and are remeasured on each reporting date with changes recorded in FV changes of warrant liabilities on the consolidated statements of operations and comprehensive loss.

Upon the consummation of the Business Combination, each Summit Warrant outstanding immediately prior had ceased to be a warrant with respect to Summit Public Shares and was assumed by YS Biopharma and converted into a YS Biopharma Warrant entitling the holder thereof to purchase such number of Ordinary Share on a one-on-one basis. After the merger with Summit, the Company accounts for the 10,750,000 public warrants as equity and 6,000,000 private warrants as liabilities.

Revenue from Contracts with Customers

YS Group follows ASC 606 — “Revenue from Contracts with Customers” for all periods presented. ASC 606 established principles for reporting information about the nature, amount, timing, and uncertainty of revenue and cash flows arising from YS Group’s contracts to provide services to customers. Based on the following five steps analysis, revenues from contracts with customers are recognized when control of the promised goods or services is transferred to the customers, in an amount that reflects the consideration YS Group expects to be entitled in exchange for those goods or services.

- Step 1: Identify the contract with the customer;
- Step 2: Identify the performance obligations in the contract;
- Step 3: Determine the transaction price;
- Step 4: Allocate the transaction price to the performance obligations in the contract; and
- Step 5: Recognize revenue when YS Group satisfies a performance obligation

YS BIOPHARMA CO., LTD AND SUBSIDIARIES
NOTES TO THE CONSOLIDATED FINANCIAL STATEMENTS
March 31, 2021, 2022 and 2023

NOTE 3 — SUMMARY OF SIGNIFICANT ACCOUNTING POLICIES (cont.)

YS Group is principally engaged in the research, development, manufacturing and sale of vaccines and therapeutic biologics. YS Group's revenues primarily streams from the sales of vaccines.

The core principle underlying the revenue recognition ASC 606 is that YS Group recognizes revenue to represent the transfer of vaccines to customers in an amount that reflects the consideration to which YS Group expects to be entitled in such exchange. This requires YS Group to identify contractual performance obligations and determine whether revenue should be recognized at a point in time or over time. YS Group's sales contracts of vaccines have one single performance obligation that is to sell vaccines to the customers. The sales contracts with customers do not involve variable considerations, such as discounts and rebates. And according to the historical operation, circumstance of discounts and rebates have never occurred. The customer pays after acceptance of the vaccines. According to ASC 606, the relevant revenue recognition is based on a point in time of customer acceptance confirmation.

In accordance with ASC606-10-55-36 through 55-40, YS Group evaluates whether it is appropriate to record the gross amount of vaccines and related costs or the net amount earned as commissions. When the entity is a principal, that the entity obtains control of the specified goods or services before they are transferred to the customers, the revenues should be recognized in the gross amount of consideration to which it expects to be entitled in exchange for the specified goods or services transferred. When the entity is an agent and its obligation is to facilitate third parties in fulfilling their performance obligation for specified goods or services, the revenues should be recognized in the net amount for the amount of commission which the entity earns in exchange for arranging for the specified goods or services to be provided by other parties. Revenues are recorded net of value-added taxes. YS Group sells vaccines to the customers, and it obtains control of the vaccines before customer acceptance confirmation. Therefore, YS Group is a principal, and the revenues should be recognized according to the gross method.

Cost of Revenues

Cost of revenues consists primarily of the cost of merchandise sold and write-down of slow-moving or obsolete inventories.

General and Administrative Expenses

General and administrative expenses consist mainly of payroll and related costs for employees involved in general corporate functions, including accounting, finance, tax, legal and human resources, professional fees, and provision for bad debts, value-added taxes and other general corporate expenses as well as costs associated with the use by these functions of facilities and equipment, such as depreciation and rental expenses.

Selling and Marketing Expenses

Selling and marketing expenses consist mainly of payroll and benefits for employees involved in the sales and distribution functions, meeting/event fees, promotion fees, marketing and selling expenses that are related to events and activities at YS Group's service centers designed to promote product sales as well as operating expenses related to the service centers.

Research and Development Expenses

R&D expenses include costs directly attributable to the conduct of R&D projects, primarily consist of salaries and other employee benefits, testing and clinical trial expenses, consulting service fees, depreciation and amortization, and office and leasing expenses. All costs associated with R&D are expensed as incurred.

Other Income (Expenses), net

Other income (expenses) consists of miscellaneous income and expenses not directly related to YS Group's core business operations. Other income primarily consists of recovery of previously written-off accounts receivable, and

YS BIOPHARMA CO., LTD AND SUBSIDIARIES
NOTES TO THE CONSOLIDATED FINANCIAL STATEMENTS
March 31, 2021, 2022 and 2023

NOTE 3 — SUMMARY OF SIGNIFICANT ACCOUNTING POLICIES (cont.)

write-off of payment obligations that are either more than three years old or no longer justifiable. Other expenses primarily consist of late fees related to YS Group's income tax and social security insurance payment obligations, charitable donation, medical waste disposal fee and financial expenses.

From December 2013 to June 2019, because YS Group was undergoing the construction and certification process of new manufacturing plant, YS Group didn't produce and market its rabies vaccine and did not pay any income taxes nor social security insurance for its employees. It accounts for late fees as disclosed in the statements of operations.

Income Taxes

Cayman Islands. Under the current laws of the Cayman Islands, YS Group is not subject to tax on income or capital gains. In addition, upon payments of dividends by YS Group to its shareholders, no Cayman Islands withholding tax is imposed.

Hong Kong. Under the Hong Kong tax laws, Yisheng Hong Kong is exempted from profit tax on its foreign-sourced income and there are no withholding taxes in Hong Kong on remittance of dividends.

Singapore. The subsidiary incorporated in Singapore files separate income tax returns in Singapore and paid Singapore statutory income tax of 17%.

China. Pursuant to the PRC Corporate Income Tax Law and the respective regulations, subsidiaries operating in China are subject to corporate income tax at 25% on the taxable income.

United States. The subsidiary incorporated in Maryland, United States is subject to statutory United States federal corporate income tax at 21% and state income tax in Maryland at 8.25%.

Current tax assets and liabilities are measured at the amount expected to be recovered from or paid to the taxation authorities, based on tax rates (and tax laws) that have been enacted or substantively enacted by the end of the Relevant Periods, taking into consideration interpretations and practices prevailing in the countries in which YS Group operates.

Deferred tax is provided, using the liability method in accordance with ASC740, *Income Taxes* ("ASC 740"), on all temporary differences at the end of each of the Relevant Periods between the tax bases of assets and liabilities and their carrying amounts for financial reporting purposes.

Deferred tax liabilities are recognized for all taxable temporary differences, except:

- when the deferred tax liability arises from the initial recognition of goodwill or an asset or liability in a transaction that is not a business combination and, at the time of the transaction, affects neither the accounting profit nor taxable profit or loss; and
- in respect of taxable temporary differences associated with investments in subsidiaries when the timing of the reversal of the temporary differences can be controlled and it is probable that the temporary differences will not reverse in the foreseeable future.

Deferred tax assets are recognized for all deductible temporary differences, and the carryforward of unused tax credits and any unused tax losses. Deferred tax assets are recognized to the extent that it is probable that taxable profit will be available against which the deductible temporary differences, and the carryforward of unused tax credits and unused tax losses can be utilized, except:

- when the deferred tax asset relating to the deductible temporary differences arises from the initial recognition of an asset or liability in a transaction that is not a business combination and, at the time of the transaction, affects neither the accounting profit nor taxable profit or loss; and

YS BIOPHARMA CO., LTD AND SUBSIDIARIES
NOTES TO THE CONSOLIDATED FINANCIAL STATEMENTS
March 31, 2021, 2022 and 2023

NOTE 3 — SUMMARY OF SIGNIFICANT ACCOUNTING POLICIES (cont.)

- in respect of deductible temporary differences associated with investments in subsidiaries, deferred tax assets are only recognized to the extent that it is probable that the temporary differences will reverse in the foreseeable future and taxable profit will be available against which the temporary differences can be utilized.

The carrying amount of deferred tax assets is reviewed at the end of each reporting period and reduced to the extent it is no longer probable that sufficient taxable profit will be available to allow all or part of the deferred tax asset to be utilized.

Deferred tax assets and liabilities are measured at the tax rates that are expected to apply to the period when the asset is realized or the liability is settled, based on tax rates (and tax laws) that have been enacted or substantively enacted by the end of the Relevant Periods.

Deferred tax assets and liabilities are offset if and only if YS Group has a legally enforceable right to set off current tax assets and current tax liabilities and the deferred tax assets and deferred tax liabilities relate to income taxes levied by the same taxation authority on either the same taxable entity or different taxable entities which intend either to settle current tax liabilities and assets on a net basis, or to realize the assets and settle the liabilities simultaneously, in each future period in which significant amounts of deferred tax liabilities or assets are expected to be settled or recovered.

YS Group records a valuation allowance to offset deferred tax assets if based on the weight of available evidence, it is more-likely-than-not that some portion, or all, of the deferred tax assets will not be realized. The effect on deferred taxes of a change in tax rate is recognized in tax expense in the period that includes the enactment date of the change in tax rate.

YS Group accounted for uncertainties in income taxes in accordance with ASC 740. Interest and penalties arising from underpayment of income taxes shall be computed in accordance with the related PRC tax law. The amount of interest expense is computed by applying the applicable statutory rate of interest to the difference between the tax position recognized and the amount previously taken or expected to be taken in a tax return. Interest and penalties recognized in accordance with ASC 740 are classified in the consolidated statements of comprehensive loss as non-operating expense.

Value Added Tax (“VAT”)

Value-added taxes (“VAT”) collected from customers relating to product sales and remitted to governmental authorities are presented on a net basis. VAT collected from customers is excluded from revenue. The VAT payable is presented in the account of accrued expenses and other liabilities.

Taxes other than Income Tax

Under the PRC Tax Law, taxes other than income tax primarily include additional tax calculated based on value-added tax payable, individual income tax, property tax, etc.

Share-based Compensation

YS Group operates a share option scheme to provide incentives and rewards to eligible participants who contribute to the success of YS Group’s operations. Employees (including directors) of Company receive granted shares and share options in the form of share-based payments, whereby employees render services as consideration for equity instruments (“equity-settled transactions”).

YS BIOPHARMA CO., LTD AND SUBSIDIARIES
NOTES TO THE CONSOLIDATED FINANCIAL STATEMENTS
March 31, 2021, 2022 and 2023

NOTE 3 — SUMMARY OF SIGNIFICANT ACCOUNTING POLICIES (cont.)

The cost of equity-settled transactions with employees for grants is measured by reference to the FV of the equity instruments at the date when they are granted. The FV is determined by an external valuer using a binomial model. The cost of equity-settled transactions is recognized in employee benefit expense, together with a corresponding increase in equity, over the period in which the performance and/or service conditions are fulfilled.

The cumulative expense recognized for equity-settled transactions at the end of each of the relevant periods until the vesting date reflects the extent to which the vesting period has expired and YS Group's best estimate of the number of equity instruments that will ultimately vest. The charge or credit to the statement of profit or loss for a period represents the movement in the cumulative expense recognized as at the beginning and end of that period. Service and non-market performance conditions are not taken into account when determining the grant date FV of awards, but the likelihood of the conditions being met is assessed as part of YS Group's best estimate of the number of equity instruments that will ultimately vest. Market performance conditions are reflected within the grant date FV. Any other conditions attached to an award, but without an associated service requirement, are considered to be non-vesting conditions. Non-vesting conditions are reflected in the FV of an award and lead to an immediate expensing of an award unless there are also service and/or performance conditions.

For awards that do not ultimately vest because non-market performance and/or service conditions have not been met, no expense is recognized. Where awards include a market or non-vesting condition, the transactions are treated as vesting irrespective of whether the market or non-vesting condition is satisfied, provided that all other performance and/or service conditions are satisfied.

Where the terms of an equity-settled award are modified, as a minimum an expense is recognized as if the terms had not been modified, if the original terms of the award are met. In addition, an expense is recognized for any modification that increases the total fair value of the share-based payments, or is otherwise beneficial to the employee as measured at the date of modification.

Where an equity-settled award is cancelled, it is treated as if it had vested on the date of cancellation, and any expense not yet recognized for the award is recognized immediately. This includes any award where non-vesting conditions within the control of either YS Group or the employee are not met. However, if a new award is substituted for the cancelled award, and is designated as a replacement award on the date that it is granted, the cancelled and new awards are treated as if they were a modification of the original award, as described in the previous paragraph. When an equity-settled award is surrendered, any expense recognized for the award is reversed immediately.

Comprehensive Loss

Comprehensive loss consists of two components, net loss and other comprehensive income (loss). Other comprehensive income (loss) consists of foreign currency translation adjustment from YS Group not using RMB as its functional currency.

Shareholders' Contribution

Main sources of shareholders' contribution include debt forgiveness from related parties, cash donations from shareholders and offering. YS Group recorded the forgiveness and donations as an increase in additional paid-in capital.

Loss Per Share

In accordance with ASC 260, Earnings Per Share, basic loss per share is computed by dividing net loss attributable to ordinary shareholders by the weighted average number of ordinary shares outstanding during the period. Diluted loss per share is calculated by dividing net loss attributable to ordinary shareholders as adjusted for the effect of dilutive ordinary equivalent shares, if any, by the weighted average number of ordinary shares plus dilutive equivalent shares

YS BIOPHARMA CO., LTD AND SUBSIDIARIES
NOTES TO THE CONSOLIDATED FINANCIAL STATEMENTS
March 31, 2021, 2022 and 2023

NOTE 3 — SUMMARY OF SIGNIFICANT ACCOUNTING POLICIES (cont.)

outstanding during the period. Dilutive equivalent shares are excluded from the computation of diluted loss per share if their effects would be anti-dilutive. No potential common shares were included in the computation of diluted loss per share when a loss from continuing operations exists.

Segment Reporting

ASC 280, “Segment Reporting”, establishes standards for reporting information about operating segments on a basis consistent with YS Group’s internal organizational structure as well as information about geographical areas, business segments and major customers in the CFS for details on YS Group’s business segments.

YS Group uses the management approach to determine reportable operating segments. The management approach considers the internal organization and reporting used by YS Group’s chief operating decision maker (“CODM”) for making decisions, allocating resources and assessing performance. YS Group’s CODM has been identified as the CEO, who reviews consolidated results when making decisions about allocating resources and assessing performance of YS Group.

Based on management’s assessment, YS Group has only one operating segment, which is the development, production, marketing and sale of biopharmaceutical products. No operating segments were aggregated to form the reportable operating segment.

Significant Risks

Currency risk

A majority of YS Group’s expenses are denominated in RMB and a significant portion of YS Group and its subsidiaries’ assets and liabilities are denominated in RMB. RMB is not freely convertible into foreign currencies. In the PRC, certain foreign exchange transactions are required by law to be transacted only by authorized financial institutions at exchange rates set by the People’s Bank of China (“PBOC”). Remittances in currencies other than RMB by YS Group in China must be processed through the PBOC or other Company foreign exchange regulatory bodies which require certain supporting documentation in order to affect the remittance.

YS Group maintains bank accounts in the PRC. On May 1, 2015, China’s new Deposit Insurance Regulation came into effect, pursuant to which banking financial institutions, such as commercial banks, established in the PRC are required to purchase deposit insurance for deposits in RMB and in foreign currency placed with them. Such Deposit Insurance Regulation would not be effective in providing complete protection for YS Group’s accounts, as its aggregate deposits are higher than the compensation limit, which is RMB500,000 for one bank. However, YS Group believes the risk of failure of any of these Chinese banks is remote. Bank failure is uncommon in the PRC and YS Group believes that those Chinese banks that hold YS Group’s cash are financially sound based on public available information.

Concentration and political risk

Currently, YS Group involves significant operation carried out in the PRC. Accordingly, YS Group’s business, financial condition and results of operations may be influenced by the political, economic and legal environment in the PRC, and by the general state of the PRC’s economy. YS Group’s operations in the PRC are subject to specific considerations and significant risks not typically associated with companies in North America and Western Europe. YS Group’s results may be adversely affected by changes in governmental policies with respect to laws and regulations, anti-inflationary measures, currency conversion and remittance abroad, and rates and methods of taxation, among other things. Although YS Group has not experienced losses from these situations and believes that it is in compliance with existing laws, this may not be indicative of future results.

YS BIOPHARMA CO., LTD AND SUBSIDIARIES
NOTES TO THE CONSOLIDATED FINANCIAL STATEMENTS
March 31, 2021, 2022 and 2023

NOTE 3 — SUMMARY OF SIGNIFICANT ACCOUNTING POLICIES (cont.)

Interest rate risk

Fluctuations in market interest rates may negatively affect YS Group's financial condition and results of operations. YS Group is exposed to floating interest rate risk on cash deposit and floating rate borrowings, and the risks due to changes in interest rates is not material. YS Group has not used any derivative financial instruments to manage YS Group's interest risk exposure.

Related Parties

A party is considered to be related to YS Group if the party directly or indirectly or through one or more intermediaries, controls, is controlled by, or is under common control with YS Group. Related parties also include principal owners of YS Group, its management, members of the immediate families of principal owners of YS Group and its management and other parties with which YS Group may deal if one party controls or can significantly influence the management or operating policies of the other to an extent that one of the transacting parties might be prevented from fully pursuing its own separate interests. A party which can significantly influence the management or operating policies of the transacting parties or if it has an ownership interest in one of the transacting parties and can significantly influence the other to an extent that one or more of the transacting parties might be prevented from fully pursuing its own separate interests is also a related party.

Recently Issued Accounting Pronouncements

In June 2016, the FASB issued Accounting Standards Update ("ASU") 2016-13, Financial Instruments — Credit Losses (Topic 326). The amendments in this Update require a financial asset (or a group of financial assets) measured at amortized cost basis to be presented at the net amount expected to be collected. The amendments broaden the information that an entity must consider in developing its expected credit loss estimate for assets measured either collectively or individually. The use of forecasted information incorporates more timely information in the estimate of expected credit loss, which will be more decision useful to users of the financial statements. This ASU is effective for annual and interim periods beginning after December 15, 2019 for issuers and December 15, 2020 for non-issuers. Early adoption is permitted for all entities for annual periods beginning after December 15, 2018, and interim periods therein. In May 2019, the FASB issued ASU 2019-05, Financial Instruments — Credit Losses (Topic 326): Targeted Transition Relief. This ASU adds optional transition relief for entities to elect the fair value option for certain financial assets previously measured at amortized cost basis to increase comparability of similar financial assets. The ASUs should be applied through a cumulative-effect adjustment to retained earnings as of the beginning of the first reporting period in which the guidance is effective (that is, a modified retrospective approach). On November 19, 2019, the FASB issued ASU 2019-10 to amend the effective date for ASU 2016-13 to be fiscal years beginning after December 15, 2022 and interim periods therein. YS Group is still evaluating the impact of accounting standard of credit losses on YS Group's CFS.

In December 2019, the FASB issued ASU 2019-12, Income Taxes (Topic 740): Simplifying the Accounting for Income Taxes, which removes certain exceptions to the general principles in Topic 740, and improves consistent application of and simplify U.S. GAAP for other areas of Topic 740 by clarifying and amending existing guidance. For public business entities, the amendments in this update are effective for fiscal years, and interim periods within those fiscal years, beginning after December 15, 2020. For all other entities, the amendments in this update are effective for fiscal years beginning after December 15, 2021, and interim periods within fiscal years beginning after December 15, 2022. Early adoption of the amendments is permitted. YS Group will adopt this ASU within annual reporting period of March 31, 2023 and expects that the adoption of this ASU did not have a material impact on YS Group's CFS.

YS Group does not believe other recently issued but not yet effective accounting standards, if currently adopted, would have a material effect on YS Group's consolidated financial position, statements of Income and comprehensive income and cash flows.

YS BIOPHARMA CO., LTD AND SUBSIDIARIES
NOTES TO THE CONSOLIDATED FINANCIAL STATEMENTS
March 31, 2021, 2022 and 2023

NOTE 4 — ACCOUNTS RECEIVABLE, NET

	As of March 31,		
	2022	2023	2023
	(RMB)	(RMB)	(US\$)
Trade receivables	322,170,980	487,418,616	\$ 70,931,300
Allowance for doubtful accounts	(13,615,875)	(24,366,824)	(3,545,967)
Accounts receivable, net	308,555,105	463,051,792	\$ 67,385,333

The allowance for doubtful accounts reflects YS Group's best estimate of probable losses inherent in the accounts receivable balance. YS Group estimates the allowance based on historical experience, the age of the accounts receivable balances, credit quality of YS Group's customers, current and forecasted future economic conditions, and other factors that may affect customers' ability to pay. During the years ended March 31, 2021, 2022 and 2023, no YS Group's accounts receivable had been written off.

Below is an analysis of the movements in the allowance for doubtful accounts:

	Year Ended March 31,		
	2022	2023	2023
	(RMB)	(RMB)	(US\$)
Balance at beginning of the year	8,530,951	13,615,875	\$ 1,981,442
Additions	5,084,924	10,750,949	1,564,525
Balance at end of the year	13,615,875	24,366,824	\$ 3,545,967

NOTE 5 — INVENTORIES, NET

YS Group's inventories consist of the following:

	As of March 31,		
	2022	2023	2023
	(RMB)	(RMB)	(US\$)
Raw materials	57,926,980	50,453,180	\$ 7,342,169
Work in progress	40,795,744	61,275,177	8,917,033
Finished goods	73,285,870	78,432,041	11,413,775
Allowance for slow-moving or obsolete inventories	(5,503,029)	(4,779,446)	(695,526)
Inventories, net	166,505,565	185,380,952	\$ 26,977,451

The movements in the allowance for slow-moving or obsolete inventories are as follows:

	Year Ended March 31,		
	2022	2023	2023
	(RMB)	(RMB)	(US\$)
Balance at beginning of the year	41,301,797	5,503,029	\$ 800,825
Additions	4,393,629	3,670,046	534,081
Inventories written off	(40,192,397)	(4,393,629)	(639,380)
Balance at end of the year	5,503,029	4,779,446	\$ 695,526

YS BIOPHARMA CO., LTD AND SUBSIDIARIES
NOTES TO THE CONSOLIDATED FINANCIAL STATEMENTS
March 31, 2021, 2022 and 2023

NOTE 6 — PROPERTY, PLANT AND EQUIPMENT, NET

Property, plant and equipment consist of the following:

	As of March 31,		
	2022	2023	2023
	(RMB)	(RMB)	(US\$)
Cost			
Construction in progress	318,000,074	309,948,621	\$ 45,105,086
Plant and buildings	170,206,987	178,756,490	26,013,430
Machinery and equipment	194,875,303	237,637,928	34,582,116
Electronic equipment	10,107,578	11,117,440	1,617,859
Motor vehicles	2,978,155	3,031,087	441,097
Office equipment and furniture	29,888,526	34,423,995	5,009,531
Leasehold improvements	4,390,980	5,597,019	814,503
Total Cost	730,447,603	780,512,580	113,583,622
Less: accumulated depreciation	(150,402,597)	(178,864,241)	(26,029,112)
Less: asset impairment	(29,891,896)	(29,891,896)	(4,349,998)
Property and equipment, net	550,153,110	571,756,443	\$ 83,204,512

In fiscal 2014, based on an evaluation of the company's related production plan and conditions of property, plant and equipment, the Company recorded an asset impairment for approximately RMB29.9 million on those property, plant and equipment that could no longer be used for production.

There are no events or changes in circumstances that indicate the carrying amount of an asset may not be fully recoverable by comparing the carrying amount of the assets to the future undiscounted cash flows expected to result from the use of the assets and their eventual disposition.

NOTE 7 — PREPAID EXPENSES AND OTHER CURRENT ASSETS, NET

Prepaid expenses and other current asset, net consist of the following:

	As of March 31,		
	2022	2023	2023
	(RMB)	(RMB)	(US\$)
Deposits ⁽¹⁾	2,807,847	4,339,791	\$ 631,545
Staff advances ⁽²⁾	383,251	606,859	88,313
Staff's social security ⁽³⁾	615,581	252,090	36,685
Value added tax recoverable ⁽⁴⁾	3,442,733	4,249,718	618,438
Clinical trial insurance ⁽⁵⁾	—	178,699	26,005
Other receivable ⁽⁶⁾	854,245	901,355	131,169
Allowance ⁽⁷⁾	(115,743)	(115,743)	(16,843)
Total	7,987,914	10,412,769	\$ 1,515,312

- (1) Deposits primarily represented deposits to Centers for Disease Control and Prevention ("CDCs") in connection with participation in the public tender process held by province-level CDCs.
- (2) Staff advances primarily represented cash advances paid to employees in advance of their expected business travel or in connection with various expense incurred in the ordinary course of business, such as sales and marketing activities.
- (3) Staff social security primarily represented the portion of the government mandated defined contribution plan that should be made by employees. But this portion should be paid to the government by YS Group on behalf of the employees pursuant to PRC labor regulation. When YS Group pays wages to employees, this portion should be deducted accordingly.
- (4) Value-added taxes ("VAT") includes input tax on purchase and output tax on sales. VAT collected from customers relating to product sales and remitted to governmental authorities is presented on a net basis, and it is excluded from revenue. YS Group is in a net VAT recoverable position when its input tax on purchase in the current year is greater than the output tax on sales. Such net amount can be deducted in the following years.
- (5) Clinical trial insurance represented human clinical trial legal liability insurance for evaluating the safety, immunogenicity and preliminary efficacy of multiple ascending doses of PIKA recombinant protein COVID-19 Vaccine in the treatment of adult patients with mild to moderate COVID-19 infection.

YS BIOPHARMA CO., LTD AND SUBSIDIARIES
NOTES TO THE CONSOLIDATED FINANCIAL STATEMENTS
March 31, 2021, 2022 and 2023

NOTE 7 — PREPAID EXPENSES AND OTHER CURRENT ASSETS, NET (cont.)

- (6) Other receivable primarily consists of prepayment to third parties, such as freight, water and electricity, and promotion fees.
- (7) The allowance reflects YS Group's best estimate of probable amounts not fully recoverable from the other receivables balance. Due to the fact that some employees resigned and lost contact, the cash paid to them in advance of their expected business travel or in connection with various expense incurred in the ordinary course of business might not be recovered.

NOTE 8 — INTANGIBLE ASSETS, NET

YS Group's intangible assets are presented below:

	As of March 31,		
	2022	2023	2023
	(RMB)	(RMB)	(US\$)
Cost			
Patents	79,608,000	79,608,000	\$ 11,584,906
Licenses, software and laboratory information system	6,143,880	10,435,478	1,518,617
Land use rights	67,181,860	67,181,860	9,776,600
Total Cost	152,933,740	157,225,338	22,880,123
Less: Accumulated Amortization	(72,215,762)	(79,168,546)	(11,520,955)
Intangible Assets, net	80,717,978	78,056,792	\$ 11,359,168

NOTE 9 — BANK LOANS AND OTHER BORROWINGS

	As of March 31,			Maturity Date	Interest Rate
	2022	2023	2023		
	(RMB)	(RMB)	(US\$)		
China Guangfa Bank Co., Ltd. – Shenyang Branch ⁽¹⁾	46,456,142	41,191,031	\$ 5,994,300	2023/10/13 – 2023/12/16	5.66%
Shanghai Pudong Development Bank Co., Ltd. Shenyang Branch ⁽²⁾	64,647,870	82,964,518	12,073,361	2023/6/29 – 2023/12/12	5.30%
Citi Bank ⁽³⁾	234,743	—	—	2022/5/1	1.00%
R-Bridge Healthcare Fund, LP ⁽⁴⁾	394,999	—	—	2026/9/15	4.00%
China CITIC Bank Shenyang Tiexi Branch ⁽⁵⁾	—	23,596,350	3,433,845	2023/10/13 – 2023/11/9	5.00%
China CITIC Bank Shenyang Tiexi Branch ⁽⁶⁾	—	5,000,000	727,622	2023/5/25 – 2023/7/17	3.25%
China Construction Bank Shenyang Heping Branch ⁽⁷⁾	—	31,330,000	4,559,279	2023/9/8 – 2023/11/24	4.00%
China Construction Bank Shenyang Heping Branch ⁽⁸⁾	—	988,000	143,778	2024/1/12	3.90%
Zhongguancun Technology Leasing Co., Ltd ⁽¹⁰⁾	—	8,666,664	1,261,212	2025/11/7	5.00%
Bank loans due within one year	111,733,754	193,736,563	\$ 28,193,397		
R-Bridge Healthcare Fund, LP ⁽⁴⁾	253,928,000	274,868,000	40,000,000	2026/9/15	4.00%
China Construction Bank Shenyang Heping Branch ⁽⁹⁾	—	4,430,000	644,673	2024/9/16	4.00%
Zhongguancun Technology Leasing Co., Ltd ⁽¹⁰⁾	—	14,492,596	2,109,026	2025/11/7	5.00%
Long-term bank loans	253,928,000	293,790,596	\$ 42,753,699		
Total bank loans	365,661,754	487,527,159	\$ 70,947,096		

- (1) On September 13, 2021, YS Group entered into a credit facility of RMB100 million with China Guangfa Bank Co., Ltd. Shenyang Branch for three years to finance its working capital requirements. YS Group drew RMB41.2 million in total from October 14 2022 to January 13, 2023 with interest at 5.66%, which is due from October 13, 2023 to December 16, 2023. In June, 2023, YS Group repaid RMB31.7 million in advance.

YS BIOPHARMA CO., LTD AND SUBSIDIARIES
NOTES TO THE CONSOLIDATED FINANCIAL STATEMENTS
March 31, 2021, 2022 and 2023

NOTE 9 — BANK LOANS AND OTHER BORROWINGS (cont.)

- (2) On July 12, 2021, YS Group entered into a credit facility of RMB140 million with Shanghai Pudong Development Bank Co., Ltd. Shenyang Branch for three years to finance its working capital requirements. YS Group drew down RMB83.0 million from June 30, 2022 to December 13, 2022 with interest at 5.30%, which is due from June 29, 2023 to December 12, 2023. In April and July, 2023, YS Group repaid RMB20.9 million and RMB32.4 million in advance, respectively.
- (3) On May 2, 2020, YS Group borrowed RMB1,103,609 (US\$166,400) with interest at 1.00% from Citi Bank. The loan was due on May 1, 2022. Before March 31, 2022, YS Group repaid approximately RMB869,000 (US\$129,422). As of March 31, 2022, the balance of approximately RMB235,000 (US\$36,978) was outstanding, which amount was repaid in full in May, 2022.
- (4) On March 16, 2022, YS Group entered into a facility agreement with R-Bridge Healthcare Fund, LP, as agent, to finance RMB274,868,000 (US\$40,000,000) for 54 months with interest at 4.00%. YS Group shall repay the loan in instalments by repaying on each Repayment Date which means the fifth business day after each financial quarter date an amount equal to the relevant percentage of the aggregate outstanding principal amount of the loan as at the end of the Availability Period as set out in the table below:

Repayment Date	Repayment Instalment
April 7, 2025	6,400,000
July 7, 2025	6,400,000
October 7, 2025	6,400,000
January 7, 2026	6,400,000
April 7, 2026	6,400,000
July 7, 2026	8,000,000
Total	40,000,000

Under the terms of the Facility Agreement, YS Group and Agent are also entering into a Deed, pursuant to which YS Group will pay to Agent, the Royalties on the Products as contingent interest in addition to the payments made to Agent under the Facility Agreement, on the terms and subject to the conditions of the Deed. YS Group is obliged to pay royalties to such agent as contingent interest for the facility based upon YS Group's annual net sales of rabies vaccines by multiplying the royalty rate ranging from 1.5% to 3.5% by the corresponding amount incremental net sales for that financial year.

YS Group shall pay accrued interest on the Loan on each Payment Date. As of March 31, 2023, YS Group accrued approximately RMB23.4 million (US\$3.4 million) of interest.

- (5) On January 13, 2023, YS Group entered into a credit facility of RMB40 million with China CITIC Bank Shenyang Tiexi Branch, due on November 29, 2023, to finance its working capital requirements. YS Group drew RMB23.6 million from January 18, 2023 to February 17, 2023 with interest at 5.00%, which is due from October 13, 2023 to November 9, 2023.
- (6) On May 6, 2022, China CITIC Bank Shenyang Tiexi Branch issued one letter of credit of RMB5.0 million to YS Group with interest at 3.25%. As of March 31, 2023, YS Group had RMB4.7 million in letters of credit issued, which is due from May 19, 2023 to July 17, 2023. From May to July 2023, YS Group repaid RMB4.7 million.
- (7) From September 9, 2022 to November 25, 2022, YS Group borrowed RMB31.3 million in total with interest at 4.00% from China Construction Bank Shenyang Heping Branch for one year. The loan will be due from September 8, 2023 to November 24, 2023. On June 5, 2023, YS Group repaid RMB9.7 million in advance.
- (8) On January 16, 2023, YS Group borrowed RMB988,000 with interest at 3.90% from China Construction Bank Shenyang Heping Branch for one year. The loan will be due on January 12, 2024.
- (9) On March 17, 2023, YS Group borrowed RMB4.4 million with interest at 4.00% from China Construction Bank Shenyang Heping Branch for 18 months. The loan will be due on September 16, 2024.
- (10) On November 8, 2022, YS Group borrowed RMB26.0 million with interest at 5.00% from Zhongguancun Technology Leasing Co., Ltd for 36 months. YS Group shall repay RMB722,222 monthly from December 15, 2022 to October 15, 2025 and pay the last repayment of RMB722,230 on November 7, 2025. YS Group repaid RMB2.9 million from December 2022 to March 2023. The balance of RMB23.1 million is outstanding, of which RMB8.6 million is due within one year. From April 13 to July 17, YS Group repaid RMB2.9 million according to the arrangement.

YS Group recorded RMB32.0 million, RMB2.8 million and RMB5.8 million of interest expense for the years ended March 31, 2023, 2022 and 2021, respectively.

YS BIOPHARMA CO., LTD AND SUBSIDIARIES
NOTES TO THE CONSOLIDATED FINANCIAL STATEMENTS
March 31, 2021, 2022 and 2023

NOTE 10 — LEASES

A summary of YS Group’s operating leases as of March 31, 2022 and 2023 is as follows:

	As of March 31,		
	2022	2023	2023
	(RMB)	(RMB)	(US\$)
Operating lease ROU assets	14,850,283	11,132,428	\$ 1,620,040
Operating lease liabilities – current	4,322,252	4,753,547	\$ 691,757
Operating lease liabilities – non-current	10,605,260	6,348,890	\$ 923,918
Weighted average remaining lease term	3.4	2.5	2.5
Weighted average discount rate	4.8%	4.7%	4.7%

A summary of lease cost recognized in YS Group’s CFS and supplemental cash flow information related to operating leases is as follows:

	Years Ended March 31,			
	2021	2022	2023	2023
	(RMB)	(RMB)	(RMB)	(US\$)
Operating lease cost	2,643,917	4,594,967	5,002,684	\$ 728,013
Cash paid for operating leases	2,601,625	4,587,894	3,349,856	\$ 487,486

A summary of maturity of operating lease liabilities under YS Group’s non-cancelable operating leases as of March 31, 2023 is as follows:

Year Ended March 31,	(RMB)	(US\$)
2024	5,178,993	\$ 753,670
2025	5,040,835	733,564
2026	1,526,270	222,110
Total lease payments	11,746,098	1,709,344
Less: Interest	(643,661)	(93,669)
Present value of operating lease liabilities	11,102,437	\$ 1,615,675

YS BIOPHARMA CO., LTD AND SUBSIDIARIES
NOTES TO THE CONSOLIDATED FINANCIAL STATEMENTS
March 31, 2021, 2022 and 2023

NOTE 11 — ACCRUED EXPENSES AND OTHER CURRENT LIABILITIES

Accrued expenses and other current liabilities consist of the following:

	As of March 31,		
	2022	2023	2023
	(RMB)	(RMB)	(US\$)
Salaries and social security insurance payable ⁽¹⁾	57,459,273	55,188,497	\$ 8,031,273
Promotion service fee ⁽²⁾	64,883,477	87,567,459	12,743,202
Taxes other than income tax	1,171,381	379,595	55,240
Late fees ⁽³⁾	9,499,595	9,927,056	1,444,629
Payable for property, plant and equipment	48,774,134	47,579,463	6,923,973
CDC transportation and storage fee	35,023,095	49,976,200	7,272,756
Guarantee deposits ⁽⁴⁾	94,528,659	108,795,884	15,832,455
Professional service fee ⁽⁵⁾	7,758,448	5,121,970	745,372
Interest payable ⁽⁶⁾	—	6,055,245	881,186
Other payable ⁽⁷⁾	7,653,291	6,945,275	1,010,707
Total	326,751,353	377,536,644	\$ 54,940,793

- (1) This payable includes unpaid salaries and outstanding social security insurance. During fiscal 2023, YS Group paid approximately RMB2.3 million to reduce its payable for salaries and social security insurance. During the period from April 1, 2023 to the date of this report, YS Group paid approximately RMB10.2 million to reduce this payable. Salaries and social security insurance payables consist of the following:

	As of March 31,		
	2022	2023	2023
	(RMB)	(RMB)	(US\$)
Salaries	49,020,045	47,390,831	\$ 6,896,522
Social security insurance	7,732,161	7,179,828	1,044,840
Union Fee	707,067	617,838	89,911
Total	57,459,273	55,188,497	\$ 8,031,273

- (2) Promotion service fee primarily represents fees for the vaccine promotion, including design and implementation of academic activities, and collection of market information.
- (3) Late fees primarily represent late fees related to corporate income tax, taxes other than income tax and social security insurance and housing reserve fund contributions due to the fact that YS Group failed to pay the income tax related to calendar year 2011 to calendar year 2013, taxes other than income tax related to calendar year 2014 to the beginning of calendar year 2021 and social security insurance related to calendar year 2015 to the beginning of calendar year 2021. As of June, 2021, YS Group has fully paid the unpaid taxes, including income tax and other taxes other than income tax, as well as the late fees charge of them. From fiscal year 2022, the late fee is incurred for unpaid social insurance.
- (4) Guarantee deposits primarily represented refundable deposits paid to YS Group by external service providers as a measurement to guarantee YS Group that external service providers will provide YS Group with high quality and reasonable professional services. The external service providers' professional service scope includes conducting market research and analysis, monitoring product clinical information, collecting and reporting adverse events of the product use, providing academic visits and education seminars, assisting product shipment and payment collections. Their services don't assume inventory risk for the vaccines before they are transferred to the end customers.
- (5) Professional service fees primarily represented service fees from consultants and other advisors.
- (6) Interest payable primarily represented interest and royalties payable to R-Bridge Healthcare Fund, LP.
- (7) Other payable primarily represented employees' reimbursement and value added tax.

YS BIOPHARMA CO., LTD AND SUBSIDIARIES
NOTES TO THE CONSOLIDATED FINANCIAL STATEMENTS
March 31, 2021, 2022 and 2023

NOTE 12 — CONVERTIBLE REDEEMABLE PREFERRED SHARES

Before Recapitalization, YS Group had two classes of preferred shares: Series A and Series B (collectively, the “Convertible Redeemable Preferred Shares”) with Series A consists of Series A and A -1. These Convertible Redeemable Preferred Shares are classified outside of the shareholders’ equity section of YS Group’s consolidated balance sheets because these shares contain deemed liquidation rights that are a contingent redemption feature not solely within the control of YS Group.

Series A

On December 10, 2012, pursuant to the Series A redeemable convertible preferred share purchase agreement and shareholders agreement (“Preferred Shares Agreements”), YS Biopharma issued 21,548,589 Series A redeemable convertible preferred shares (“Series A Preferred Share”) to Asia Ventures II L.P., and Beacon Bioventures Fund III Limited Partnership (renamed as “F-Prime Capital Partners Healthcare Fund III LP” on December 30, 2015), collectively with any of their respective affiliates which holds Series A Preferred Shares, at US\$0.93 per share for US \$20,000,000, of which 6,014,313 shares of Series A were transferred as Series A -1 on September 4, 2020.

Series A-1

On September 4, 2020, pursuant to the share purchase agreement entered into by and among Asia Ventures II L.P., (“Asia Ventures”), F-Prime Capital Partners Healthcare Fund III LP (“F-Prime”) and Haitong XuYu International Limited, Epiphron Capital (Hong Kong) Limited, 3W Global Investment Limited, OrbiMed New Horizons Master Fund, L.P. and HH SUM XXXVI Holdings Limited (collectively “Purchasers”), Asia Ventures and F-Prime transferred 6,014,313 Series A Preferred Shares to the Purchasers. As of March 31, 2022, 15,534,276 shares Series A and 6,014,313 shares Series A-1 were issued and outstanding.

Series B

In January 2021, the principal amount of Convertible Notes (see Note 12) together with the accrued interest of US \$20,389,315 were converted into 18,393,610 Series B Preferred Shares at US \$1.1085 per share, and the convertible note holders also exercised their call option rights under the Convertible Notes and converted into 9,660,324 Series B preferred shares at US \$2.0703 per share.

In January 2021, YS Group raised US \$88,000,000 by issuance of 36,129,245 Series B Preferred Shares to Oceanpine Investment Fund II LP, AIHC Master Fund, 3W Global Fund, MSA Growth Fund II, L.P., Epiphron Capital (Hong Kong) Limited, Wudaokou Capital Limited and Gennex China Growth Fund.

In February 2021, YS Group raised US \$3,000,000 by way of issuance of 1,231,679 Series B Preferred Shares to Superstring Capital Master Fund LP.

On March 16, 2023, YS Biopharma closed its public offering. Thus, all the convertible redeemable preferred share were converted to ordinary shares on four-to-one basis at par value US\$0.00002 as the agreements.

YS BIOPHARMA CO., LTD AND SUBSIDIARIES
NOTES TO THE CONSOLIDATED FINANCIAL STATEMENTS
March 31, 2021, 2022 and 2023

NOTE 12 — CONVERTIBLE REDEEMABLE PREFERRED SHARES (cont.)

The following table summarizes YS Group's outstanding Convertible Redeemable Preferred Shares for the three years ended March 31, 2023:

	Series A		Series A-1		Series B		Total	Total
	Shares	Carrying Value	Shares	Carrying Value	Shares	Carrying Value	Carrying Value	Carrying Value
		(RMB)		(RMB)		(RMB)	(RMB)	(US\$)
As of March 31, 2020	21,548,589	440,585,213	—	—	—	—	440,585,213	\$ 69,403,171
Conversion of convertible notes	—	—	—	—	18,393,610	131,425,527	131,425,527	20,702,802
Call option under convertible notes	—	—	—	—	9,660,324	131,425,290	131,425,290	20,702,765
New insurance	—	—	—	—	37,360,924	597,987,709	597,987,709	94,197,995
Shares transferred	(6,014,313)	(68,232,451)	6,014,313	68,232,451	—	—	—	—
Accretion to redemption value	—	1,758,690	—	—	—	14,851,607	16,610,297	2,616,536
Foreign currency translation adjustment	—	(29,449,559)	—	(2,567,136)	—	(558,770)	(32,575,465)	(5,131,449)
As of March 31, 2021	15,534,276	344,661,893	6,014,313	65,665,315	65,414,858	875,131,363	1,285,458,571	\$ 202,491,820
Accretion to redemption value	—	57,598,340	—	5,164,090	—	67,899,896	130,662,326	20,582,579
Foreign currency translation adjustment	—	(12,696,574)	—	(2,318,596)	—	(30,884,335)	(45,899,505)	(7,230,318)
As of March 31, 2022	15,534,276	389,563,659	6,014,313	68,510,809	65,414,858	912,146,924	1,370,221,392	\$ 215,844,081
Accretion to redemption value	—	65,904,705	—	5,463,610	—	66,623,382	137,991,697	20,081,159
Foreign currency translation adjustment	—	34,734,369	—	5,866,010	—	77,857,300	118,457,680	795,044
Converted to ordinary shares	(15,534,276)	(490,202,733)	(6,014,313)	(79,840,429)	(65,414,858)	(1,056,627,606)	(1,626,670,769)	(236,720,284)
As of March 31, 2023	—	—	—	—	—	—	—	—

Convertible Preferred Stock Rights and Preferences

Conversion rights: Each holder of the Preferred Shares has the right, at each holder's sole discretion, to convert at any time and from time to time, all or any portion of the Preferred Shares into ordinary shares. The initial conversion ratio shall be on a one for one basis, subject to certain general anti-dilution adjustments.

The Preferred Shares will be automatically converted into ordinary shares upon (i) the closing of an initial public offering (IPO) based on the applicable then-effective conversion price or (ii) upon the date specified by written consent or agreement of the holder of the majority of the then outstanding Preferred Shares, voting together as a single class on an as-converted basis.

The initial conversion price and conversion ratio is the stated issuance price of the Preferred Shares and on a one for-one basis, respectively. The above conversion prices are subject to adjustments in the event that YS Biopharma issues additional ordinary shares or additional deemed ordinary shares through options or convertible instruments for a consideration per share received by YS Biopharma less than the original respective conversion prices, as the case may be, in effect on the date of and immediately prior to such issue. In such event, the respective conversion price is reduced, concurrently with such issue, to a price as adjusted according to an agreed-upon formula. The above conversion prices are also subject to adjustments on a proportional basis upon other dilution events.

Voting rights: Each holder of the Preferred Share is entitled to the number of votes equal to the number of ordinary shares into which such holder's preferred shares could be converted. The holders of the Preferred Shares shall vote together with ordinary shareholders, and not as a separate class or series, on all matters put before the shareholders.

YS BIOPHARMA CO., LTD AND SUBSIDIARIES
NOTES TO THE CONSOLIDATED FINANCIAL STATEMENTS
March 31, 2021, 2022 and 2023

NOTE 12 — CONVERTIBLE REDEEMABLE PREFERRED SHARES (cont.)

Liquidation preference: Upon any liquidation, dissolution or winding up of YS Biopharma, either voluntary or involuntary (a “Liquidation Event”), the assets of YS Biopharma available for distribution shall be distributed in the following order: (i) each Series B Holder shall be entitled to receive, prior and in preference to any distribution of any of the assets of YS Biopharma to the Series A Holders and the Ordinary Holders, an amount per Series B Preferred Share held by such Series B Holder equal to the applicable Original Series B Issue Price plus a single interest at the rate of 8% of the applicable Original Series B Issue Price on an annum basis accumulated from the Original Series B Issue Date to the date such Series B Holder actually receives such repayment, plus all declared and accrued but unpaid dividends on each such Series B Preferred Share (collectively, the “Series B Liquidation Preference”); if the assets available to be distributed among the Series B Holders shall be insufficient to permit the payment to such holders, then the assets of YS Biopharma legally available for distribution shall be all distributed to the Series B Holders that would otherwise be respectively qualified therefor and entitled thereon such Series B Liquidation Preference on a pro rata basis; (ii) after full payment of the Series B Liquidation Preference, each Series A Holder shall be entitled to receive, prior and in preference to any distribution of any of the assets of YS Biopharma to the Ordinary Holders, an amount per Series A Preferred Share held by such Series A Holder equal to the applicable Original Series A Issue Price plus a single interest at the rate of 8% of the applicable Original Series A Issue Price on an annum basis accumulated from the applicable Original Series A Issue Date to the date such Series A Holder actually receives such repayment, plus all declared and accrued but unpaid dividends on each such Series A Preferred Share (collectively, the “Series A Liquidation Preference”, together with the Series B Liquidation Preference, the “Liquidation Preference”); if the assets available to be distributed among the Series A Holders shall be insufficient to permit the payment to such holders, then the assets of YS Biopharma legally available for distribution shall be all distributed to the Series A Holders that would otherwise be respectively qualified therefor and entitled thereon such Series A Liquidation Preference on a pro rata basis; (iii) if there are assets of YS Biopharma available for distribution after payment of the Liquidation Preference referred to in clauses (i) and (ii) above, the remaining assets of YS Biopharma available for distribution to the Shareholders shall be distributed ratably among the Ordinary Holders and Preferred Holders on an as-converted basis.

Dividends: No dividends, whether in cash, property, or shares of YS Biopharma or otherwise, shall be declared or paid on any other shares during any previous or current fiscal year of YS Biopharma unless and until a dividend in like or greater amount has first been declared or paid on each outstanding Preferred Share (on an as-if-converted basis). All accrued and unpaid dividends, if any shall, to the extent funds are legally available therefor and subject to YS Biopharma being able to pay its debts as they fall due and the value of YS Biopharma’s assets exceeding its liabilities immediately after any payment of such dividends, be mandatorily paid upon the earlier to occur of (i) a Liquidation Event, (ii) an optional conversion of Preferred Shares, (iii) an automatic conversion of Preferred Shares and (iv) a redemption of Preferred Shares. No dividends were declared by YS Biopharma’s Board of Directors to date.

Redemption right: The Preferred Shares are redeemable at the option of the holders for all or any less portion of the Preferred Shares as provided herein at any time following:

- The issuance date when YS Biopharma and its subsidiaries or any ordinary share holder has material default or breach of the Preferred Shares Agreements in terms of its representation, warranties, covenants and obligations and if such breach remains uncured for 30 days after holders of the Preferred Shares give a written request to YS Group; or
- the third (3rd) anniversary of the Original Series B Issue Date, if a Qualified IPO is not achieved; In respect of the Series A Preferred Shares held by Asia Ventures and F -Prime, provided however that during the eighteen (18) months period after January 28, 2021, Asia Ventures and F-Prime shall not exercise its redemption rights pursuant to that if YS Group is still actively preparing for a Qualified IPO; In respect of the Series A Preferred Shares held by the Series A -1 Holders, at any time following the third (3rd) anniversary of January 28, 2021, if a Qualified IPO is not achieved; or
- When Mr. Zhang, the Founder and Director of YS Biopharma ceases to be employed or provide service to YS Biopharma.

YS BIOPHARMA CO., LTD AND SUBSIDIARIES
NOTES TO THE CONSOLIDATED FINANCIAL STATEMENTS
March 31, 2021, 2022 and 2023

NOTE 12 — CONVERTIBLE REDEEMABLE PREFERRED SHARES (cont.)

Since the Series A, Series A-1 and Series B Convertible Redeemable Preferred Shares are redeemable at a determinable price on a determinable date, at the option of the holder, or upon occurrence of an event that depends solely on the passage of time, these Convertible Redeemable Preferred Shares are accounted for as mezzanine equity on the consolidated balance sheets.

The mezzanine equity is carried at the higher of (1) the carrying amount after the attribution of net income of YS Group or (2) the expected redemption value. YS Group accretes for the difference between the initial carrying value and the ultimate redemption price using the effective interest rate method (17% annual compound interest for Series A, 8% annual compound interest for Series A-1 and Series B) from the issuance dates to the earliest possible redemption date.

On March 16, 2023, YS Biopharma Co., Ltd. (the “Company”) issued a press release that announced the completion of its business combination with Summit Healthcare Acquisition Corp, and that the ordinary shares and warrants of the Company are to begin trading on the Nasdaq Capital Market on March 17, 2023. Thus, all the convertible redeemable preferred shares were converted to the ordinary share at par value US\$0.00002 on four-to-one basis.

NOTE 13 — WARRANTS

As of March 31, 2023, YS Group has 10,750,000 public warrants and 6,000,000 private warrants.

YS Group accounts for its outstanding warrants in accordance with ASC 815-40-15-7D and 7F. Management determined that the private warrants do not meet the criteria for equity treatment and must be recorded as liabilities. Accordingly, YS Group classifies the private warrants as liabilities at their FV and adjusts the private warrants to FV at each reporting period. Management has further determined that its public warrants qualify for equity treatment. Warrant liability is subject to re-measurement at each balance sheet date until exercised, and any change in FV is recognized in statements of operations. The private warrants are valued using a Binomial Option Pricing Model.

Upon the consummation of the business combination, each Summit Warrant outstanding immediately prior has ceased to be a warrant with respect to Summit Public Shares and be assumed by YS Biopharma and converted into a YS Biopharma Warrant entitling the holder thereof to purchase such number of Ordinary Share on a one-on-one basis. Each YS Biopharma Warrant will otherwise continue to have and be subject to substantially the same terms and conditions as were applicable to such Summit Warrant immediately prior to the consummation of the Business Combination (including any repurchase rights and cashless exercise provisions). Upon the consummation of the Business Combination with Summit, YS Group has 10,000,000 public and 6,000,000 private warrants.

The private warrants are accounted for as liabilities in accordance with ASC 815-40 and are presented within warrant liabilities on the balance sheets. The warrants were classified as Level 3 at the initial measurement date due to the use of unobservable inputs. The Binomial Option Pricing Model with the following key assumptions is used for estimating the FV of private warrants.

	As of March 31, 2023
Fair value of the underlying asset as of the Valuation Date	1.6
Strike price	11.5
Life to expiration (Years.)	4.9
Volatility	62.9%
Number of steps	100
Redemption price (per share)	0.1

YS BIOPHARMA CO., LTD AND SUBSIDIARIES
NOTES TO THE CONSOLIDATED FINANCIAL STATEMENTS
March 31, 2021, 2022 and 2023

NOTE 13 — WARRANTS (cont.)

As of March 31, 2023, the value of the private warrants was RMB8.7 million. The change in FV from March 31, 2022 to March 31, 2023 was RMB21,358. The table below reflects the movement of warrant liabilities for the year ended March 31, 2023:

	April 1, 2022	Additions	Change in fair value	Foreign currency translation	March 31, 2023	March 31, 2023
	(RMB)	(RMB)	(RMB)	(RMB)	(RMB)	(US\$)
Private Warrants	—	8,814,592	(21,358)	(845)	8,792,389	\$ 1,279,507
Total	—	8,814,592	(21,358)	(845)	8,792,389	\$ 1,279,507

NOTE 14 — WARRANTS ACCOUNTED AS EQUITY-METHOD INSTRUMENTS

Upon the consummation of the Business Combination with Summit, Summit's 10,000,000 public warrants were converted into YS Biopharma warrants, and YS Group sold additional 750,000 units of public warrants.

Following the Business Combination, YS Biopharma may redeem public warrants prior to their exercise at a time that is disadvantageous to the holders of such warrants, thereby making such warrants worthless. More specifically:

- YS Biopharma will have the ability to redeem outstanding warrants at any time after they become exercisable and prior to their expiration, at a price of \$0.01 per warrant, provided that the last reported sales price of YS Biopharma Ordinary Shares equals or exceeds \$18.00 per share (as adjusted for capitalization, share dividends, split-up and the like) for any 20 trading days within a 30 trading-day period ending on the third trading day prior to proper notice of such redemption and provided that certain other conditions are met.
- YS Biopharma will also have the ability to redeem outstanding warrants at any time after they become exercisable and prior to their expiration, at a price of \$0.10 per warrant upon a minimum of 30 days' prior written notice of redemption provided that the last reported sales price of YS Biopharma Ordinary Shares equals or exceeds \$10.00 per share (as adjusted for capitalization, share dividends, split-up and the like) for any 20 trading days within a 30 trading-day period ending on the third trading day prior to proper notice of such redemption and provided that certain other conditions are met, including that holders of the Warrants will be able to exercise their Warrants prior to redemption for a number of YS Biopharma Ordinary Shares determined based on the redemption date and the fair market value of the YS Biopharma Ordinary Shares. The value received upon exercise of the Warrants (1) may be less than the value the holders would have received if they had exercised their Warrants at a later time where the underlying share price is higher and (2) may not compensate the holders for the value of the warrants, including because the number of YS Biopharma Ordinary Shares received is capped at 0.361 YS Biopharma Ordinary Shares per warrant (subject to adjustment) irrespective of the remaining life of the warrants.

In each case, YS Biopharma may only call the Warrants for redemption upon a minimum of 30 days' prior notice of redemption.

Redemption of the outstanding Warrants could force holders of the Warrants to (a) exercise Warrants and pay the exercise price therefor at a time when it may be disadvantageous for such holders to do so, (b) sell Warrants at the then-current market price when they might otherwise wish to hold their Warrants or (c) accept the nominal redemption price which, at the time the outstanding Warrants are called for redemption, is likely to be substantially less than the market value of the Warrants.

YS BIOPHARMA CO., LTD AND SUBSIDIARIES
NOTES TO THE CONSOLIDATED FINANCIAL STATEMENTS
March 31, 2021, 2022 and 2023

NOTE 15 — STOCK-BASED COMPENSATION

YS Group operates a share-based payment scheme (the “Scheme”) for the purpose of providing incentives and rewards to eligible participants who contribute to the success of YS Group’s operations. Eligible participants of the Scheme include YS Group’s directors, employees and consultants.

The 2010 Share Incentive Plan

On June 21, 2010, YS Group adopted the 2010 Share Incentive Plan (the “Plan”) that has a contractual term of 10 years. The Plan provides for the granting of stock options and other stock-based awards to employees and directors. YS Group’s Board of Directors authorized and reserved for the issuance of up to 2,725,650 ordinary shares under the Plan for the period from 2010 to 2013, giving retroactive effect of combination in March 2023. Starting from 1 January 2014, the maximum number of shares subject to awards that may be granted during any single calendar year is equal to 1.5% of total issued and outstanding shares as of the first business day of that calendar year.

The stock options granted to employees are accounted for as equity awards and measured at their grant date fair values. Options that vest based on service conditions generally will become vested over a three-year period in equal quarterly instalments of 0.08% each on the last day of every quarter that has elapsed until the options are 100% vested.

On January 1, 2015, an annual grant of 127,500 options, giving retroactive effect of combination in March 2023, which vest based on performance conditions, were granted to various employees. The annual grant was applicable for calendar years 2015, 2016, 2017, 2018, 2019 and 2020, respectively. The options become vested in equal quarterly instalments based on performance targets established on January 1st of each calendar year from 2015 to 2020. There are no more grants after December 31, 2020 under the 2010 share incentive plan.

For options granted to YS Group’s senior executives, the grantee can exercise vested options after the commencement date of exercise and before the earlier of 1) its contractual term (i.e., 10 years after each of its vesting date); or 2) 5 years after the grantee terminates their employment if the vested option has not been exercised.

For options granted to the remaining employees, the grantee can exercise vested options after the commencement date of exercise and before the earlier of 1) its contractual term (i.e., 10 years after each of its vesting date); or 2) 12 months after the grantee terminates their employment if the vested option has not been exercised.

For those awards, evaluations are made as of each reporting period to assess the likelihood of performance criteria being met. Share-based payment expenses are then adjusted to reflect the revision of original estimates.

The exercise prices and exercise periods, giving retroactive effect of combination in March 2023, of the share options outstanding as at the end of each of the Relevant Periods are as follows:

	Number of shares options	Average exercise price per share option
	(RMB)	
As of March 31, 2021	3,253,565	29.3156
Granted during the period	—	—
Forfeited during the period	—	—
Exercised during the period	—	—
Expired during the period	—	—
As of March 31, 2022	3,253,565	29.3156
Granted during the period	—	—
Forfeited during the period	—	—
Exercised during the period	—	—
Expired during the period	—	—
As of March 31, 2023	3,253,565	32.4020

YS BIOPHARMA CO., LTD AND SUBSIDIARIES
NOTES TO THE CONSOLIDATED FINANCIAL STATEMENTS
March 31, 2021, 2022 and 2023

NOTE 15 — STOCK-BASED COMPENSATION (cont.)

The exercise prices and exercise periods, giving retroactive effect of combination in March 2023, of the share options outstanding as at the end of the reporting periods are as follows:

Year Ended 31 March 2023 Number of options	Exercise price (RMB)	Exercise period
1,533,252	13.938	2021 – 2031
613,369	25.8524	2021 – 2026
1,106,944	52.5376	2021 – 2026
3,253,565		

Bonus incentive plan

On January 1, 2015, YS Group launched a bonus incentive program effective for six years from launch date. The bonus incentive program is divided into two six-month periods each calendar year. The bonus incentive program specifies for each monthly tranche in the six-month period an independent performance condition for a stated period of service (i.e., one month). The bonus amount is determined on a monthly basis at month-end by the human resources department based on a reasonably objective performance criteria that serves as a basis for promotion and other compensation decisions. A fixed conversion price is then applied to the employee's month end bonus to determine the number of ordinary shares to be issued to the employee for each individual month. At the end of each respective six-month period, YS Group finalizes the vested ordinary shares to be issued to the employee.

Based on the above, the employee does not receive a number of ordinary shares with a FV equal to a predominantly fixed dollar amount on the delivery date. Hence, the ordinary shares granted to employees are accounted for as equity awards. In addition, each monthly tranche should be accounted for as a separate award with its own service inception date, grant-date FV, and respective requisite service period because the employee's ability to retain (vest in) the award pertaining to the current month is not dependent on service beyond the current month.

Restricted share units ("RSU")

Giving retroactive effect of combination in March 2023, on February 1, 2018, YS Group granted 692,500 RSUs to employees under the Plan. The weighted average grant-date FV of restricted shares units granted was \$7.24, which was derived from the FV of the underlying ordinary shares. 405,000 out of the 692,500 restricted share units were subject to service conditions vesting in six equal semi-annual instalments over three years or eight equal semi-annual instalments over four years, respectively. The remaining 287,500 RSUs had been vested on March 16, 2023 due to the successful closing of the public offering. YS Group recognized expenses associated with these RSUs immediately in fiscal 2023. As of March 31, 2023, all the granted options are vested, and there were no unrecognized share-based payment expenses related to unvested restricted shares.

Giving retroactive effect of combination in March 2023, on July 25, 2018, YS Group granted 270,000 units of RSUs to three independent directors. Starting from the effective date of August 1, 2018, 30,000 RSUs will be awarded to each of the three directors annually, which shall be vested in equal portion of 7,500 units per three months' Director services rendered by each director. For each of the new directors, 5,000 units will be vested for the two-month period starting from August 1, 2018, and the remaining are vested on quarterly basis starting from October 1, 2018 to July 31, 2021. The grant-date FV of the restricted share units was \$1.84, which was derived from the FV of the underlying ordinary shares. As of March 31, 2023, all the granted options are vested and there were no unrecognized share-based payment expenses related to unvested restricted shares.

YS BIOPHARMA CO., LTD AND SUBSIDIARIES
NOTES TO THE CONSOLIDATED FINANCIAL STATEMENTS
March 31, 2021, 2022 and 2023

NOTE 15 — STOCK-BASED COMPENSATION (cont.)*The 2020 Share Incentive Plan*

On December 31, 2020, YS Group's board of directors adopted the 2020 Share Incentive Plan for the purpose of granting share-based compensation awards to employees, directors and consultants to incentivize their performance and align their interests with YS Group. Pursuant to such plan, YS Group is entitled to grant awards to directors, employees and consultants of YS Group with rights to subscribe for up to 8,750,000 underlying ordinary shares of YS Biopharma. As of the date of this report, (1) 2,093,418 shares as RSU incentive shares have been fully vested and issued to the respective directors and employees of YS Group, and (2) 6,656,582 shares are reserved but not issued, among which, options to subscribe for 3,471,546 ordinary shares of YS Biopharma are granted to certain senior management and employees of YS Group but not exercised, giving retroactive effect of combination in March 2023.

Stock-based compensation expense included in YS Group's consolidated statements of operations and comprehensive loss is as follows:

	Years Ended March 31,			
	2021	2022	2023	2023
	(RMB)	(RMB)	(RMB)	(US\$)
Research and development	4,200,464	975,171	(997,846)	\$ (145,211)
General and administrative	72,501,943	6,789,277	4,502,847	655,274
Selling and marketing	54,093	—	—	—
Total stock-based compensation	76,756,500	7,764,448	3,505,001	\$ 510,063

On August 15, 2022, unanimous written resolution of the board of director of YS Group accepted the notice from a former employee, for the surrender of 143,750 of issued shares with US\$0.00002 each in YS Group registered in his name, giving retroactive effect of combination in March 2023.

NOTE 16 — RELATED PARTY TRANSACTIONS AND BALANCES

The following companies are related parties that had balances or transactions with YS Group as of and during the fiscal years ended March 31, 2021, 2022 and 2023:

Name of related parties	Relationship with YS Group
Yisheng Biopharma Co., Ltd	An entity controlled by Yi Zhang
Yisheng Biopharma Holdings Ltd.	An entity controlled by Yi Zhang
Kaifeng Yisheng Pan-Asia Technology Co., Ltd	An entity controlled by Yi Zhang
Beijing Yisheng Xingye Technology Co., Ltd.	An entity controlled by Yi Zhang
Changchun Bailong Biotechnology Co., Ltd.	An entity controlled by Yi Zhang
Henan Yisheng Huizhong Health Services Co., Ltd.	An entity controlled by Yi Zhang
Henan Yisheng Biopharma Co., Ltd.	An entity controlled by Yi Zhang
Beijing Huaerdun Kangqi Biotechnology Co., Ltd.	An entity controlled by Yi Zhang
Liaoning Yisheng Pan-Asia	An entity controlled by Yi Zhang
Yi Zhang	Chairman of Board of Directors
Hui Shao	Chief Executive Officer
Zhongkai Shi*	Chief Medical Officer
Nan Zhang	Daughter of the Chairman
Xu Zhang	Daughter of the Chairman

* Zhongkai Shi resigned in September 2021.

YS BIOPHARMA CO., LTD AND SUBSIDIARIES
NOTES TO THE CONSOLIDATED FINANCIAL STATEMENTS
March 31, 2021, 2022 and 2023

NOTE 16 — RELATED PARTY TRANSACTIONS AND BALANCES (cont.)*Transactions with related parties*

YS Group had the following transactions with related parties, all of which are interest-free during the fiscal years ended March 31, 2021, 2022 and 2023:

	Years Ended March 31,			
	2021	2022	2023	2023
	(RMB)	(RMB)	(RMB)	(US\$)
Amounts due from related party:				
Yisheng Biopharma Holdings Limited (Hong Kong)				
Receivable collected on behalf of YS Group	30,088,833	2,966,777	—	—
Repayment to YS Group		33,055,610	—	—

In fiscal 2021, YS Group lent RMB30,088,833 to Yisheng Biopharma Holdings Limited (Hong Kong) for its operating needs. In fiscal 2022, YS Group lent another RMB2,966,777 to Yisheng Biopharma Holdings Limited (Hong Kong), and Yisheng Biopharma Holdings Limited (Hong Kong) repaid RMB33,055,610 in full to YS Group. As of March 31, 2022, the balance of amount due from Yisheng Biopharma Holdings Limited (Hong Kong) is RMB nil.

NOTE 17 — INCOME TAX

Cayman Islands. Under the current laws of the Cayman Islands, YS Group is not subject to tax on income or capital gains. In addition, upon payments of dividends by YS Group to its shareholders, no Cayman Islands withholding tax is imposed.

Hong Kong. Under the Hong Kong tax laws, Yisheng Hong Kong, as a holding company, is exempted from profit tax on its foreign-sourced income and there are no withholding taxes in Hong Kong on remittance of dividends.

Singapore. Yisheng Singapore, a subsidiary incorporated in Singapore, files separate income tax returns in Singapore at the statutory income tax rate of 17%.

China. Under the Enterprise Income Tax (“EIT”) Law of the PRC, domestic enterprises and Foreign Investment Enterprises (the “FIE”) are usually subject to a unified 25% EIT rate while preferential tax rates, tax holidays, and even tax exemption may be granted on case-by-case basis. The PRC tax authorities grant preferential tax treatment to High and New Technology Enterprises (“HNTEs”). Under this preferential tax treatment, HNTEs are entitled to an income tax rate of 15%, subject to a requirement that they re-apply for HNTE status every three years. Since Liaoning Yisheng was approved as an HNTE in December 2021, Liaoning Yisheng is entitled to a reduced income tax rate of 15% and is able to enjoy the reduced income tax rate in the next three years.

United States. US Yisheng, a subsidiary incorporated in Maryland, United States is subject to statutory federal corporate income tax at a rate of 21% and state income tax at a rate of 8.25%.

The provision for income tax consisted only of deferred tax.

YS BIOPHARMA CO., LTD AND SUBSIDIARIES
NOTES TO THE CONSOLIDATED FINANCIAL STATEMENTS
March 31, 2021, 2022 and 2023

NOTE 17 — INCOME TAX (cont.)

The following table reconciles the statutory rate to YS Group's effective tax rate:

	Years Ended March 31,		
	2021	2022	2023
PRC statutory income tax rate	25.00%	25.00%	25.00%
Effect of different tax rates in different jurisdictions	(20.56)%	(18.26)%	(36.00)%
Effect of PRC preferential tax rate	(0.77)%	4.56%	8.72%
Effect of research and development expenses deduction and others	7.8%	33.2%	25.50%
Temporary differences*	10.01%	4.88%	0.79%
Change in valuation allowance	(11.49)%	(44.47)%	(23.23)%
Effective tax rate	9.99%	4.91%	0.78%

* Temporary differences primarily relate to impairment of inventories, property, plant and equipment and government grants.

Net deferred tax assets as of March 31, 2022 and 2023, consist of the following key components:

	As of March 31,		
	2022	2023	2023
	(RMB)	(RMB)	(US\$)
Deferred tax assets:			
Write-down of inventories to net realizable value	825,454	716,917	\$ 104,329
Impairment of property, plant and building	2,031,460	1,769,405	257,492
Deferred government grants	4,852,383	3,296,223	479,681
Losses available for offsetting against future taxable profits	58,257,270	39,366,020	5,728,716
Less: valuation allowance	(58,257,270)	(39,366,020)	(5,728,716)
Total deferred tax assets, net	7,709,297	5,782,545	841,502
Deferred tax liabilities:			
Fair value adjustments arising from historical acquisition of subsidiaries	(4,670,213)	(3,876,964)	(564,193)
Total deferred tax liabilities	(4,670,213)	(3,876,964)	(564,193)
Net deferred tax asset	3,039,084	1,905,581	\$ 277,309

In assessing the realizability of the net deferred tax assets, YS Group considers all relevant positive and negative evidence in determining whether it is more likely than not that some portion or all of the deferred income tax assets will not be realized. The realization of the gross deferred tax assets is dependent on several factors, including the generation of sufficient taxable income in the future. Based upon an assessment of the level of historical taxable income and projections for future taxable income over the periods in which the deferred tax assets are deductible or can be utilized. The amount of the deferred tax asset is considered unrealizable because it is more likely than not that YS Group will not generate sufficient future taxable income to utilize this portion of the net operating loss.

Uncertain tax positions

There were no uncertain tax positions as of March 31, 2022 and 2023 and management does not anticipate any potential future adjustments which would result in a material change to its tax positions.

YS BIOPHARMA CO., LTD AND SUBSIDIARIES
NOTES TO THE CONSOLIDATED FINANCIAL STATEMENTS
March 31, 2021, 2022 and 2023

NOTE 18 — DEFERRED GOVERNMENT GRANTS

Deferred government grants represent funds received from the PRC government for R&D, investment in building or improvement in YS Group’s production facilities. These specific subsidies are recorded as deferred government grants upon receipt and are recognized as government grants recognized in income when the conditions are met. Other subsidies are recognized as other income upon receipt as further performance by YS Group is not required. YS Group received government grants that were deferred in the amount of RMB4.0 million and RMB3.6 million in fiscal 2023 and 2022, respectively. In addition, YS Group received RMB15.7 million and RMB20.8 million other subsidies that the government has not set any conditions and are not tied to future trends or performance of YS Group and were recognized in other income in 2023 and 2022, respectively.

Deferred government grants included the following:

	As of March 31,		
	2022	2023	2023
	(RMB)	(RMB)	(US\$)
Government grants for property, plant and equipment			
Balance at beginning of the year	21,847,340	22,030,690	\$ 3,206,003
Addition	1,552,000	—	—
Recognized as income	(1,368,650)	(1,455,678)	(211,837)
Subtotal	22,030,690	20,575,012	\$ 2,994,166
Government grants for research and development			
Balance at beginning of the year	11,158,551	10,318,528	\$ 1,501,598
Addition	—	4,000,000	582,098
Recognized as income	(840,023)	(8,991,332)	(1,308,458)
Subtotal	10,318,528	5,327,196	\$ 775,238
Total deferred government grants	32,349,218	25,902,208	\$ 3,769,404
Less: current portion	2,295,701	2,295,701	\$ 334,081
Non-current portion	30,053,517	23,606,507	\$ 3,435,323

Government grants for property, plant and equipment

YS Group has seven deferred government grants related to property, plant and equipment, and has fulfilled the conditions attached to all the grants. RMB1.5 million was amortized from deferred government grant into government grant recognized in income in fiscal 2023, as compared to RMB1.4 million for the fiscal year ended March 31, 2022. RMB1.5 million will be amortized in fiscal 2024 which was included in the current deferred government grant and RMB19.1 million will be amortized after 2024 which was included in the non-current portion of deferred government grants. Nil was recorded as government grant recognized in income for the fiscal year ended March 31, 2023, as compared to RMB18.5 million for the fiscal years ended March 31, 2022.

Government grants for research and development

YS Group has four deferred government grants related to various R&D projects, and fulfilled the conditions attached to three grants. RMB9.0 million was amortized from deferred government grant into government grant recognized in income in fiscal 2023, as compared to RMB0.8 million for the fiscal year ended March 31, 2022. RMB0.8 million will be amortized in fiscal 2024 which was included in the current deferred government grant and RMB4.5 million will be amortized after 2023 which was included in the non-current portion of deferred government grants. RMB0.1 million was recorded as government grant recognized in income for the year ended March 31, 2023, as compared to RMB2.0 million for the years ended March 31, 2022.

YS BIOPHARMA CO., LTD AND SUBSIDIARIES
NOTES TO THE CONSOLIDATED FINANCIAL STATEMENTS
March 31, 2021, 2022 and 2023

NOTE 19 — COMMITMENTS AND CONTINGENCIES

As of March 31, 2023, YS Group has the following commitments to purchase raw materials or services:

	As of March 31,	
	2023	2023
	(RMB)	(US\$)
Other professional service fee	3,229,699	\$ 470,000
Research and development	185,648,604	27,016,401
Purchase raw materials	15,528,566	2,259,785
Total	204,406,869	\$ 29,746,186

In 2018, Liaoning Yisheng filed a sales contract dispute with Hebei Defense Biological Products Supply Center. The Supreme People’s Court of Liaoning supported the Liaoning Yisheng’s claim that the defendant Hebei Weifang should pay RMB2,465,807 for Liaoning Yisheng vaccine within 20 days after the judgment came into effect. As of the date of this report, YS Group has received RMB1,636,755 compensation from Hebei Defense Biological Products Supply Center, and the balance of RMB829,052 compensation may be received in fiscal 2024.

In 2019, Liaoning Yisheng filed a sales contract dispute with Chaoyang Center for Disease Control and Prevention. The Supreme People’s Court of Liaoning supported the Liaoning Yisheng’s claim that the defendant Chaoyang Center for Disease Control and Prevention should pay RMB416,900 for Liaoning Yisheng vaccine. To the date, YS Group received RMB380,000 from Chaoyang Center for Disease Control and Prevention, and the balance of RMB36,900 may be received in the second half of 2023.

In 2023, Liaoning Yisheng was involved in a dispute with Shenyang Haoyu Landscape Engineering Co., Ltd who claimed that Liaoning Yisheng should pay RMB278,707 for the greening construction. As the proceedings are in the early stages, there is considerable uncertainty regarding the timing or ultimate resolution of such matters, and therefore, an estimate for the reasonably possible loss or a range of reasonably possible losses cannot be made.

YS Group was also involved in certain other labor disputes as of March 31, 2023. As the proceedings are in the early stages or the second appeal, there is considerable uncertainty regarding the timing or ultimate resolution of such matters, and therefore, an estimate for the reasonably possible loss or a range of reasonably possible losses cannot be made.

NOTE 20 — SEGMENT INFORMATION

Based on management’s assessment, YS Group has one operating segment, which is the development, production, marketing and sale of biopharmaceutical products. No operating segments were aggregated to form the reportable operating segment.

YS Group’s non-current assets are located in the PRC and other countries, such as Singapore and United States. The location of these non-current assets can be aggregated to form the reportable geographical segment.

	As of March 31,		
	2022	2023	2023
	(RMB)	(RMB)	(US\$)
PRC	604,094,049	645,210,788	\$ 93,893,911
Other countries/regions	26,777,039	4,602,447	\$ 669,769

The non-current asset information above is based on the location of the assets and excludes financial instruments and deferred tax assets.

YS BIOPHARMA CO., LTD AND SUBSIDIARIES
NOTES TO THE CONSOLIDATED FINANCIAL STATEMENTS
March 31, 2021, 2022 and 2023

NOTE 21 — SUBSEQUENT EVENTS

YS Group performed an evaluation of events and transactions for potential recognition or disclosure through the date of this report. YS Group is not aware of any material subsequent events other than those disclosed below and elsewhere in the notes to the consolidated financial statements.

On May 9, 2023, YS Biopharma (Philippines) Inc. (“Philippines Yisheng”) was incorporated under the laws of Philippines as an entity owned by YS Group. Philippines Yisheng was incorporated for the purpose of research, development, producing, wholesaling and commercializing pharmaceutical products, including vaccines and other biological products.

On April 28, 2023, YS Group borrowed RMB6.7 million with interest at 5.3% from Shanghai Pudong Development Bank Co., Ltd. due on December 23, 2023.

From May 17, 2023 to June 7, 2023, YS Group borrowed RMB10.3 million with interest at 4.0% from China Construction Bank Shenyang Heping Branch for 18 months due in November and December, 2024.

From May 24, 2023 to July 18, 2023, YS Group borrowed RMB16.4 million with interest at 5.0%, of which RMB3.6 million with interest at 4.75%, from China CITIC Bank Shenyang Tiexi Branch due from February, 2024 to May 2024.

On May 29, 2023, YS Group borrowed RMB40.0 million with interest at 4.8% from CITIC Financial Leasing Co., Ltd due on May 29, 2026.

From June 19, 2023 to July 11, 2023, YS Group borrowed RMB13.3 million with interest at 5.66% from China Guangfa Bank Co., Ltd. Shenyang Branch due on December 16, 2023.

From July 7, 2023 to July 19, 2023, YS Group borrowed RMB11.3 million with interest at 4.0% from Minsheng Bank Shenyang Huanghe Street Branch due in July, 2024.

NOTE 22 — PARENT COMPANY ONLY CONDENSED FINANCIAL INFORMATION (UNAUDITED)

Pursuant to the requirements of Rule 12-04(a), 5-04(c) and 4-08(c)(3) of Regulation S-X, the condensed financial information of the parent company shall be filed when the restricted net assets of consolidated subsidiaries exceed 25% of consolidated net assets as of the end of the most recently completed fiscal year. YS Group performed a test on the restricted net assets of consolidated subsidiaries in accordance with such requirement and concluded that it was applicable to YS Group as the restricted net assets of YS Group’s PRC subsidiaries exceeded 25% of the consolidated net assets of YS Group. Therefore, the condensed financial statements of the parent company are included herein.

YS BIOPHARMA CO., LTD AND SUBSIDIARIES
NOTES TO THE CONSOLIDATED FINANCIAL STATEMENTS
 March 31, 2021, 2022 and 2023

NOTE 22 — PARENT COMPANY ONLY CONDENSED FINANCIAL INFORMATION (UNAUDITED)
 (cont.)

PARENT COMPANY BALANCE SHEETS

	As of March 31,		
	2022	2023	2023
	(RMB)	(RMB)	(US\$)
	(Unaudited)	(Unaudited)	(Unaudited)
ASSETS			
Current Assets			
Cash	252,611,535	3,045,660	\$ 443,218
Amounts due from related parties	519,236,876	1,039,986,896	151,343,466
Total current assets	771,848,411	1,043,032,556	151,786,684
Non-current assets			
Long-term investments, net	146,641,652	158,734,357	23,099,722
Total non-current assets	146,641,652	158,734,357	23,099,722
Total Assets	918,490,063	1,201,766,913	\$ 174,886,406
LIABILITIES AND EQUITY			
Current Liabilities			
Accrued expenses and other liabilities	244,082,464	461,105,636	\$ 67,102,120
Warrants liability	—	8,792,389	1,279,507
Amounts due to related parties	3,155,395	3,415,603	497,054
Total current liabilities	247,237,859	473,313,628	68,878,681
Total Liabilities	247,237,859	473,313,628	68,878,681
Mezzanine equity			
Series A and A-1 redeemable convertible preferred shares (par value US\$0.000005 per share, 50,000,000 shares authorized; 21,548,589 shares issued and outstanding)	458,074,468	—	—
Series B redeemable convertible preferred shares (par value US\$0.000005 per share, 100,000,000 shares authorized; 65,414,858 shares issued and outstanding)	912,146,924	—	—
Total mezzanine equity	1,370,221,392	—	—
Shareholders' (deficit)/equity:			
Ordinary shares, par value US\$0.00002 per share; 9,950,000,000 shares authorized; 61,827,883 and 93,058,197 shares issued and outstanding as of March 31, 2022 and 2023, respectively;*	7,978	12,297	1,790
Additional paid-in capital	808,502,018	2,656,891,036	386,642,466
Accumulated deficit	(1,590,567,163)	(1,874,037,965)	(272,718,245)
Accumulated other comprehensive income/(loss)	83,087,979	(54,412,083)	(7,918,286)
Total shareholders' (deficit)/equity	(698,969,188)	728,453,285	106,007,725
Total liabilities, mezzanine equity and shareholders' (deficit)/equity	918,490,063	1,201,766,913	\$ 174,886,406

* Gives retroactive effect to reflect the reorganization in February 2021 and business combination in March 2023.

YS BIOPHARMA CO., LTD AND SUBSIDIARIES
NOTES TO THE CONSOLIDATED FINANCIAL STATEMENTS
March 31, 2021, 2022 and 2023

NOTE 22 — PARENT COMPANY ONLY CONDENSED FINANCIAL INFORMATION (UNAUDITED) (cont.)

PARENT COMPANY STATEMENTS OF OPERATIONS AND COMPREHENSIVE LOSS

	Years Ended March 31,			
	2021	2022	2023	2023
	(RMB)	(RMB)	(RMB)	(US\$)
	(Unaudited)	(Unaudited)	(Unaudited)	(Unaudited)
Equity loss of subsidiaries	(60,903,713)	(75,864,722)	(138,758,136)	\$ (20,192,694)
Operating expenses:				
Selling and marketing	54,278	—	—	—
General and administrative	104,562,058	29,178,255	7,630,726	1,110,456
Research and development	4,352,356	988,531	(887,280)	(129,121)
Total operating expenses	108,968,692	30,166,786	6,743,446	981,335
Loss from operations	(169,872,405)	(106,031,508)	(145,501,582)	(21,174,029)
Other income (expenses):				
Financial income/(expenses)	(21,953,837)	27,107	1,119	163
Fair value changes of warrant liability	—	—	21,358	3,108
Total other income/(expense), net	(21,953,837)	27,107	22,477	3,271
Net income/(loss)	(191,826,242)	(106,004,401)	(145,479,105)	(21,170,758)
Accretion to redemption value of convertible redeemable preferred shares	(16,610,297)	(130,662,326)	(137,991,697)	(20,081,159)
Net loss attributable to YS Biopharma	(208,436,538)	(236,666,727)	(283,470,802)	(41,251,917)
Net loss	(191,826,242)	(106,004,401)	(145,479,105)	(21,170,758)
Foreign currency translation gain(loss)	22,455,217	38,864,606	(137,500,062)	(20,009,614)
Total comprehensive loss	(169,371,025)	(67,139,795)	(282,979,167)	\$ (41,180,372)
Loss per share*:				
– Basic and Diluted	(3.10)	(1.71)	(1.56)	\$ (0.23)
Weighted average number of ordinary shares outstanding*:				
– Basic and Diluted	61,827,883	61,827,883	93,058,197	93,058,197

* Gives retroactive effect to reflect the reorganization in February 2021 and combination in March 2023.

YS BIOPHARMA CO., LTD AND SUBSIDIARIES
NOTES TO THE CONSOLIDATED FINANCIAL STATEMENTS
March 31, 2021, 2022 and 2023

NOTE 22 — PARENT COMPANY ONLY CONDENSED FINANCIAL INFORMATION (UNAUDITED) (cont.)

PARENT COMPANY STATEMENTS OF CASH FLOWS

	Years Ended March 31,			
	2021	2022	2023	2023
	(RMB)	(RMB)	(RMB)	(US\$)
	(Unaudited)	(Unaudited)	(Unaudited)	(Unaudited)
Net loss	(191,826,242)	(106,004,401)	(145,479,105)	\$ (21,170,758)
Equity loss of subsidiaries	60,903,713	75,864,722	138,758,136	20,192,694
Share-based compensation	76,756,500	7,764,448	3,505,001	510,063
Fair value changes of warrant liability	—	—	(21,358)	(3,108)
Changes in operating assets and liabilities:				
Amounts due from related parties	(421,125,633)	(23,299,705)	(520,750,020)	(75,781,833)
Amounts due to related parties	2,906,881	(110,893)	260,208	37,867
Accrued expenses and other liabilities	77,228,629	(24,732,348)	48,377,785	7,040,148
Net cash used in operating activities	(395,156,152)	(70,518,177)	(475,349,353)	(69,174,927)
Cash flows from investing activities:				
Payment for long-term investment	(7,658,738)	(813,776)	—	—
Net cash used in investing activities	(7,658,738)	(813,776)	—	—
Cash flows from financing activities:				
Proceeds from issuance of mezzanine equity	729,412,999	—	—	—
Shareholders' contributions	1,589,236	—	—	—
Proceeds from acquisition	—	—	252,457,329	36,738,701
Offering cost	—	—	(35,884,661)	(5,222,094)
Net cash provided by financing activities	731,002,235	—	216,572,668	31,516,607
Effect of exchange rate on cash	2,109,604	(6,353,461)	9,210,810	1,340,397
Net (decrease) increase in cash	330,296,949	(77,685,414)	(249,565,875)	(36,317,923)
Cash at the beginning of the year	—	330,296,949	252,611,535	36,761,141
Cash at the end of the year	330,296,949	252,611,535	3,045,660	\$ 443,218
Non-cash transactions:				
Accretion to redemption value of convertible redeemable preferred shares	16,610,297	130,662,326	(137,991,697)	\$ (20,081,159)
Forgiveness from related parties	446,092,527	—	—	—
Equity transaction from warrants	—	—	(8,870,007)	\$ (1,290,802)
Equity transaction from preferred shares	—	—	1,636,897,084	\$ 238,208,461

PART II

INFORMATION NOT REQUIRED IN PROSPECTUS

Item 6. Indemnification of Directors and Officers

The laws of the Cayman Islands do not limit the extent to which a company's memorandum and articles of association may provide for indemnification of officers and directors, except to the extent any such provision may be held by the Cayman Islands courts to be contrary to public policy, such as to provide indemnification against willful default, willful neglect, civil fraud or the consequences of committing a crime. The Amended YS Biopharma Articles provides for indemnification of our officers and directors against all actions, proceedings, costs, charges, expenses, losses, damages or liabilities incurred or sustained by such person, other than by reason of such person's own dishonesty, wilful default or fraud, in or about the conduct of YS Biopharma's business or affairs (including as a result of any mistake of judgment) or in the execution or discharge of his duties, powers, authorities or discretions, including without prejudice to the generality of the foregoing, any costs, expenses, losses or liabilities incurred by such person in defending (whether successfully or otherwise) any civil proceedings concerning YS Biopharma or its affairs in any court whether in the Cayman Islands or elsewhere.

Under the indemnification agreement, we will agree to indemnify each such person and hold him harmless against expenses, judgments, fines and amounts payable under settlement agreements in connection with any threatened, pending or completed action, suit or proceeding to which he has been made a party or in which he became involved by reason of the fact that he is or was our director or officer. Except with respect to expenses to be reimbursed by us in the event that the indemnified person has been successful on the merits or otherwise in defense of the action, suit or proceeding, our obligations under the indemnification agreements are subject to certain customary restrictions and exceptions.

In addition, we maintain standard policies of insurance under which coverage is provided to our directors and officers against loss arising from claims made by reason of breach of duty or other wrongful act, and to us with respect to payments which may be made by us to such directors and officers pursuant to the above indemnification provision or otherwise as a matter of law.

Insofar as indemnification for liabilities arising under the Securities Act may be permitted to directors, officers or persons controlling us pursuant to the foregoing provisions, we have been informed that in the opinion of the SEC such indemnification is against public policy as expressed in the Securities Act and is therefore unenforceable.

Item 7. Recent Sales of Unregistered Securities

In the past three years, YS Biopharma issued the following securities that were not registered under the Securities Act. Each of these securities were issued in reliance upon the exemptions provided by Section 4(a)(2) and/or Regulation S under the Securities Act. No underwriters were involved in these issuances of securities.

On November 16, 2020, YS Biopharma was incorporated under the laws of Cayman Islands as an exempted company with limited liability. On the same day, one fully paid share of YS Biopharma with a par value of US\$0.000005 was transferred from ICS Corporate Services (Cayman) Limited, an independent third party, to An Diang Group Holdings Limited, an offshore holding company wholly-owned by Mr. Yi Zhang, and YS Biopharma issued 155,887,999 pre-consolidation ordinary shares of YS Biopharma ("Pre-Consolidation Ordinary Shares") with a par value of US\$0.000005 each at nominal value to An Diang Group Holdings Limited. On December 10, 2020 and from January 28, 2021 to February 2, 2021, YS Biopharma issued an aggregate of 56,995,618 Pre-Consolidation Ordinary Shares, 21,548,589 pre-consolidation Series A preferred shares, 37,360,924 pre-consolidation Series B preferred shares and 28,053,934 pre-consolidation Series B1 preferred shares to the then existing shareholders of YS Biopharma. Upon completion of YS Biopharma Capital Restructuring and prior to the consummation of the Business Combination, YS Biopharma had 83,424,995 Ordinary Shares in total with par value \$0.00002 per share.

We adopted the YS Biopharma 2022 Plan on September 23, 2022. The maximum number of Ordinary Shares that may be issued under the YS Biopharma 2022 Plan are 6,656,582 Ordinary Shares. As of the date of this prospectus, YS Biopharma granted 3,471,546 options to certain director and employees. See "Management — Share Incentive Plans" for further details.

Item 8. Exhibits

The following exhibits are filed herewith unless otherwise indicated:

Exhibit No.	Description	Incorporation by Reference				
		Filed Herewith	Form	File No.	Exhibit No.	Filing Date
2.1	Business Combination Agreement, dated as of September 29, 2022, by and among Summit, YS Biopharma, Merger Sub I and Hudson Biomedical Group.		F-4	333-269031	2.1	December 28, 2022
2.2	Plan of Merger (First Merger).		F-4	333-269031	2.2	December 28, 2022
2.3^	Plan of Merger (Second Merger).					
3.1^	Amended and Restated Memorandum and Articles of Association of YS Biopharma.					
4.1	Specimen ordinary share certificate of YS Biopharma.		F-4	333-269031	4.5	December 28, 2022
4.2	Specimen warrant certificate of YS Biopharma.		F-4	333-269031	4.6	December 28, 2022
4.3	Warrant Assignment Agreement, dated as of September 29, 2022, by and among YS Biopharma, Summit and Continental Stock Transfer & Trust Company.		F-4	333-269031	4.7	December 28, 2022
5.1^	Opinion of Mourant Ozannes (Hong Kong) LLP as to validity of ordinary shares of YS Biopharma to be issued.					
10.1	Shareholder Support Agreement and Deed, dated as of September 29, 2022, by and among Summit, YS Biopharma, certain shareholders of YS Biopharma, Sponsor, and other parties thereto.		F-4	333-269031	10.1	December 28, 2022
10.2	YS Biopharma 2022 Equity Incentive Plan.		F-4	333-269031	10.5	December 28, 2022
10.3	Form of Indemnification Agreement between YS Biopharma and each executive officer of YS Biopharma.		F-4	333-269031	10.6	December 28, 2022
10.4*	Facility Agreement, dated as of March 16, 2022, by and among YishengBio Co., Ltd, Yishengbio (Hong Kong) Holdings Limited, Yisheng US Biopharma Inc., Yisheng Biopharma (Singapore) Pte. Ltd., Liaoning Yisheng Biopharma Co. Ltd., Beijing Yisheng Biotechnology Co., Ltd., R-Bridge Investment Three Pte. Ltd. And R-BRIDGE Healthcare Fund, LP.		F-4	333-269031	10.9	December 28, 2022
10.5*	Royalty Deed, dated as of March 16, 2022, by and among Yishengbio (Hong Kong) Holdings Limited and R-Bridge Healthcare Fund, LP.		F-4	333-269031	10.10	December 28, 2022
10.6*	Deed of Undertaking, dated as of March 16, 2022, by and among Yishengbio (Hong Kong) Holdings Limited and R-Bridge Healthcare Fund, LP.		F-4	333-269031	10.11	December 28, 2022

[Table of Contents](#)

Exhibit No.	Description	Incorporation by Reference				
		Filed Herewith	Form	File No.	Exhibit No.	Filing Date
10.7*	English translation of Guarantee Agreement, dated as of March 16, 2022, by and among Liaoning Yisheng Biopharma Co. Ltd., Beijing Yisheng Biotechnology Co., Ltd. and R-Bridge Healthcare Fund, LP.		F-4	333-269031	10.12	December 28, 2022
10.8*	Acting-In-Concert Agreement dated March 3, 2021 entered into by and among the Concert Parties.		F-4	333-269031	10.13	December 28, 2022
21.1	List of principal subsidiaries		20-F	001-41598	8.1	July 26, 2023
23.2	Consent of Wei, Wei & Co., LLP.	√				
23.3^	Consent of Frost & Sullivan.					
23.4^	Consent of Maples and Calder (Hong Kong) LLP (included in Exhibit 5.1).					
23.6^	Consent of Jingtian & Gongcheng.					
24.1^	Power of Attorney (including on signature page).					
101.INS	Inline XBRL Instance Document					
101.SCH	Inline XBRL Taxonomy Extension Schema Document					
101.CAL	Inline XBRL Taxonomy Extension Calculation Linkbase Document					
101.DEF	Inline XBRL Taxonomy Extension Definition Linkbase Document					
101.LAB	Inline XBRL Taxonomy Extension Label Linkbase Document					
101.PRE	Inline XBRL Taxonomy Extension Presentation Linkbase Document					
104	Cover Page Interactive Data File (embedded within the Inline XBRL document)					
107^	Filing Fee Table.					

^ Previously filed

* Portions of this exhibit have been omitted pursuant to Item 601(b)(10)(iv) of Regulation S-K.

Item 9. Undertakings

The undersigned registrant hereby undertakes:

- (1) To file, during any period in which offers or sales are being made, a post-effective amendment to this registration statement:
 - i. To include any prospectus required by Section 10(a)(3) of the Securities Act of 1933;
 - ii. To reflect in the prospectus any facts or events arising after the effective date of the registration statement (or the most recent post-effective amendment thereof) which, individually or in the aggregate, represent a fundamental change in the information set forth in the registration statement. Notwithstanding the foregoing, any increase or decrease in volume of securities offered (if the total dollar value of securities offered would not exceed that which was registered) and any deviation from the low or high end of the estimated maximum offering range may be reflected in the form

[Table of Contents](#)

of prospectus filed with the Commission pursuant to Rule 424(b) if, in the aggregate, the changes in volume and price represent no more than 20 percent change in the maximum aggregate offering price set forth in the "Calculation of Registration Fee" table in the effective registration statement.

- iii. To include any material information with respect to the plan of distribution not previously disclosed in the registration statement or any material change to such information in the registration statement.
- (2) That, for the purpose of determining any liability under the Securities Act of 1933, each such post-effective amendment shall be deemed to be a new registration statement relating to the securities offered therein, and the offering of such securities at that time shall be deemed to be the initial bona fide offering thereof.
- (3) To remove from registration by means of a post-effective amendment any of the securities being registered which remain unsold at the termination of the offering.
- (4) To file a post-effective amendment to the registration statement to include any financial statements required by Item 8.A of Form 20-F at the start of any delayed offering or throughout a continuous offering.

Insofar as indemnification for liabilities arising under the Securities Act of 1933 may be permitted to directors, officers and controlling persons of the registrant pursuant to the foregoing provisions, or otherwise, the registrant has been advised that in the opinion of the SEC such indemnification is against public policy as expressed in the Act and is, therefore, unenforceable. In the event that a claim for indemnification against such liabilities (other than the payment by the registrant of expenses incurred or paid by a director, officer or controlling person of the registrant in the successful defense of any action, suit or proceeding) is asserted by such director, officer or controlling person in connection with the securities being registered, the registrant will, unless in the opinion of its counsel the matter has been settled by controlling precedent, submit to a court of appropriate jurisdiction the question whether such indemnification by it is against public policy as expressed in the Act and shall be governed by the final adjudication of such issue.

That, for the purpose of determining liability of the registrant under the Securities Act of 1933 to any purchaser in the initial distribution of the securities, the undersigned registrant undertakes that in a primary offering of securities of the undersigned registrant pursuant to this registration statement, regardless of the underwriting method used to sell the securities to the purchaser, if the securities are offered or sold to such purchaser by means of any of the following communications, the undersigned registrant will be a seller to the purchaser and will be considered to offer or sell such securities to such purchaser:

- any preliminary prospectus or prospectus of the undersigned registrant relating to the offering required to be filed pursuant to Rule 424;
- any free writing prospectus relating to the offering prepared by or on behalf of the undersigned registrant or used or referred to by the undersigned registrant;
- the portion of any other free writing prospectus relating to the offering containing material information about the undersigned registrant or its securities provided by or on behalf of the undersigned registrant; and
- any other communication that is an offer in the offering made by the undersigned registrant to the purchaser.

The undersigned registrant hereby undertakes as follows: that prior to any public reoffering of the securities registered hereunder through use of a prospectus which is a part of this registration statement, by any person or party who is deemed to be an underwriter within the meaning of Rule 145(c), the issuer undertakes that such reoffering prospectus shall contain the information called for by the applicable registration form with respect to reofferings by persons who may be deemed underwriters, in addition to the information called for by the other items of the applicable form.

The registrant undertakes that every prospectus: (1) that is filed pursuant to the immediately preceding paragraph, or (2) that purports to meet the requirements of Section 10(a)(3) of the Act and is used in connection with an offering of securities subject to Rule 415, shall be filed as a part of an amendment to the registration statement and shall not be used until such amendment is effective, and that, for purposes of determining any liability under the Securities Act of 1933, each such post-effective amendment shall be deemed to be a new registration statement relating to the securities offered therein, and the offering of such securities at that time shall be deemed to be the initial bona fide offering thereof.

[Table of Contents](#)

The undersigned registrant hereby undertakes to respond to requests for information that is incorporated by reference into the prospectus pursuant to Item 4, 10(b), 11, or 13 of this form, within one business day of receipt of such request, and to send the incorporated documents by first class mail or other equally prompt means. This includes information contained in documents filed subsequent to the effective date of the registration statement through the date of responding to the request.

The undersigned registrant hereby undertakes to supply by means of a post-effective amendment all information concerning a transaction, and the company being acquired involved therein, that was not the subject of and included in the registration statement when it became effective.

SIGNATURES

Pursuant to the requirements of the Securities Act of 1933, the registrant has duly caused this registration statement on Form F-1 to be signed on its behalf by the undersigned, thereunto duly authorized, in Beijing, PRC, on January 23, 2024.

YS Biopharma Co., Ltd.
By: /s/ Ajit Shetty
Name: Ajit Shetty
Title: Independent Director and Interim Chairperson

Each person whose signature appears below constitutes and appoints Hui Shao as attorney-in-fact with full power of substitution for her or him in any and all capacities to do any and all acts and all things and to execute any and all instruments which said attorney and agent may deem necessary or desirable to enable the registrant to comply with the Securities Act of 1933, as amended (the "Securities Act"), and any rules, regulations and requirements of the Securities and Exchange Commission thereunder, in connection with the registration under the Securities Act of ordinary shares of the registrant (the "Shares"), including, without limitation, the power and authority to sign the name of each of the undersigned in the capacities indicated below to the Registration Statement on Form F-1 (the "Registration Statement") to be filed with the Securities and Exchange Commission with respect to such Shares, to any and all amendments or supplements to such Registration Statement, whether such amendments or supplements are filed before or after the effective date of such Registration Statement, to any related Registration Statement filed pursuant to Rule 462(b) under the Securities Act, and to any and all instruments or documents filed as part of or in connection with such Registration Statement or any and all amendments thereto, whether such amendments are filed before or after the effective date of such Registration Statement; and each of the undersigned hereby ratifies and confirms all that such attorney and agent shall do or cause to be done by virtue hereof.

Pursuant to the requirements of the Securities Act, this Registration Statement has been signed by the following persons in the capacities and on the dates indicated.

Signature	Title	Date
/s/ Hui Shao	Director and Chief Executive Officer	January 23, 2024
Hui Shao	<i>(Principal Executive Officer)</i>	
/s/ Ajit Shetty	Independent Director and Interim Chairperson	January 23, 2024
Ajit Shetty		
/s/ Viren Mehta	Independent Director	January 23, 2024
Viren Mehta		
/s/ Rui Yu	Independent Director	January 23, 2024
Rui Yu		
/s/ Shaojing Tong	Independent Director	January 23, 2024
Shaojing Tong		
/s/ Chunyuan Wu	Chief Financial Officer	January 23, 2024
Chunyuan Wu	<i>(Principal Financial and Accounting Officer)</i>	

AUTHORIZED REPRESENTATIVE

Pursuant to the requirement of the Securities Act of 1933, the undersigned, solely in his capacity as the duly authorized representative of YS Biopharma Co., Ltd., has signed this registration statement in the City of New York, New York, on January 23, 2024.

<p>COGENCY GLOBAL INC. Authorized U.S. Representative</p> <p>By: <u>/s/ COLLEEN A. DE VRIES</u> Name: Colleen A. De Vries Title: Senior Vice-President on behalf of Cogency Global Inc.</p>
--



• MAIN OFFICE

133-10 39TH AVENUE
FLUSHING, NY 11354
TEL. (718) 445-6308
FAX. (718) 445-6760

• CALIFORNIA OFFICE

440 E HUNTINGTON DR.
STE 300
ARCADIA, CA 91006
TEL. (626) 282-1630
FAX. (626) 282-9726

• BEIJING OFFICE

11/F NORTH TOWER
BEIJING KERRY CENTRE
1 GUANGHUA ROAD
CHAORYANG DISTRICT
BEIJING, 100020, PRC
TEL. (86 10) 65997923
FAX. (86 10) 65999100

CONSENT OF INDEPENDENT REGISTERED PUBLIC ACCOUNTING FIRM

We consent to the inclusion in this Registration Statement of YS Biopharma Co., Ltd. on Post-Effective Amendment No. 2 to Form F-1 (File No. 333-271221) of our report dated July 26, 2023, with respect to our audits of the consolidated financial statements of YS Biopharma Co. Ltd. (formerly, YishengBio Co., Ltd.) and Subsidiaries as of March 31, 2023 and 2022, and for each of the years in the three-year period ended March 31, 2023.

We also consent to the reference to us under the heading “Experts” in such Registration Statement.

/s/ Wei, Wei & Co., LLP

Flushing, New York
January 22, 2024

